

# PIKA

## Suspended Micro Linear

### Key Features

- Compact micro-linear family in direct, indirect, and direct/indirect
- A versatile mix of optical distributions for shaping light with intent
- Micro baffle options in white or black for added visual comfort
- Magnetic snap-joiners support straight runs with tight seams
- Small-diameter cable combines power and suspension in one streamlined solution
- Remote driver architecture supports Pika's remarkably small profile
- Rotational aiming with discrete angle marks and locking screws



Example Part #: PKD-WB-N-830HO-N-6'-CAC48JB-U-FSD-1-0-W



PK__	---	---	-----
SERIES	DIRECT SHIELDING	INDIRECT SHIELDING	DIRECT SOURCE <sup>1</sup>
<b>PKD</b> - Pika Direct <b>PKI</b> - Pika Indirect <b>PKDI</b> - Pika Direct/Indirect <i>Housing pg. 2</i>	<b>A</b> - Frosted Diffuse <b>BW</b> - Batwing <b>WHE</b> - Asymmetric <b>DA</b> - Double Asymmetric <b>WG</b> - Wall Graze <i>Shielding pg. 2</i>	<b>D60</b> - 60° <b>D40</b> - 40° <b>D20</b> - 20° <b>WB</b> - White Micro Baffle <b>BB</b> - Black Micro Baffle <b>N</b> - None	<b>HE</b> - Lambertian <b>BW</b> - Batwing <b>WHE</b> - Asymmetric <b>CWA</b> - Asymmetric Ceiling Wash <b>N</b> - None <i>Shielding pg. 2</i>
			<b>27</b> __ - 2700K <b>LO</b> - 250 lms/ft <b>30</b> __ - 3000K <b>MO</b> - 500 lms/ft <b>35</b> __ - 3500K <b>HO</b> - 750 lms/ft <b>40</b> __ - 4000K <b>VHO</b> - 1000 lms/ft <b>CL</b> _____ - Custom Lumens <b>CW</b> _____ - Custom Watts <b>N</b> - None <i>Source pg. 3</i>

INDIRECT SOURCE <sup>1</sup>	LENGTH OR PATTERN <sup>2</sup>	MOUNTING <sup>3</sup>	VOLTAGE	REMOTE DRIVER
<b>27</b> __ - 2700K <b>LO</b> - 250 lms/ft <b>30</b> __ - 3000K <b>MO</b> - 500 lms/ft <b>35</b> __ - 3500K <b>HO</b> - 750 lms/ft <b>40</b> __ - 4000K <b>VHO</b> - 1000 lms/ft <b>CL</b> _____ - Custom Lumens <b>CW</b> _____ - Custom Watts <b>N</b> - None <i>Source pg. 4</i>	__ - Individual Fixture ___ - Continuous Row <i>Micro Hubs</i> <b>HS</b> __ - Square <b>HR</b> _X_ - Rectangle <b>HU</b> _X_X_ - U-Shape <b>HL</b> _X_ - L Shape <b>HT</b> _X_X_ - T-Shape <b>HX</b> _X_X_X_ - X-Shape <b>HH</b> _ - Hexagon <b>HY</b> _X_X_ - Y-Shape <i>Length or Pattern pg. 5</i>	<b>CAC</b> _G_ - Power Cable Suspension to Grid <b>CAC</b> _JB_ - Power Cable Suspension to J Box <i>Mounting pg. 5</i>	<b>U</b> - Universal (120 thru 277V) <b>1</b> - 120V <b>2</b> - 277V <b>3</b> - 347V <i>Voltage pg. 6</i>	<b>FSD</b> - Factory Select Driver (1%, 0-10v) <b>PL2</b> - Advance Xitanium (1%, 0-10v) <b>OL2</b> - eldoLED Optotronic (1%, 0-10v) <b>OL4</b> - eldoLED Optotronic 347v (1%, 0-10v) <b>EE1</b> - eldoLED ECoDrive (1%, 0-10v) <b>ES1</b> - eldoLED SOLOdrive (0.1%, 0-10v) <b>LH1</b> - Lutron Hi-Lume (1%, EcoSystem) <i>Remote Driver pg. 6</i>

CIRCUITING	BATTERY & EMERGENCY <sup>4</sup>	FINISH	ENDCAP OPTIONS <sup>5</sup>	FIXTURE OPTIONS
<b>1</b> - Single Circuit <b>2</b> - Dual Circuit (direct/indirect) <b>E</b> - Emergency (entire fixture) <i>Circuiting pg. 6</i>	<b>0</b> - None <b>_FSB</b> - Factory Select Battery <b>_FSG</b> - Factory Select ALCR <b>_ILL</b> - Iota 10w <b>_PLL</b> - Bodine 10w <i>Battery &amp; Emergency pg. 6-7</i>	<b>W</b> - White <b>BL</b> - Textured Black <b>AL</b> - Matte Aluminum <b>CC</b> - Custom Color Powder Coat <i>Finish pg. 7</i>	<b>FE</b> - Flat Endcap <b>RT</b> - Rotational Endcap <b>RE</b> - Rounded Endcap <b>AW</b> - Flat w/ White Accent <b>ABL</b> - Flat w/ Black Accent <b>ACA</b> - Flat w/ Anodized Clear Accent <b>AGD</b> - Flat w/ Anodized Gold Accent <i>Endcap pg. 7</i>	<b>RBW</b> - Decorative Remote Box, White <b>RBB</b> - Decorative Remote Box, Black <i>Fixture Options pg. 7</i>

<sup>1</sup>When specifying CRI - CCT & OUTPUT the first \_\_ is for specifying either **8** - 80CRI or **9** - 90CRI. The ending \_\_ are for specifying output, example **HO** - High Output. See output charts for more information. <sup>2</sup>Individual fixtures come in **2', 3', 4', 5', 6', 7', & 8'** lengths. Continuous row come in 1' increments. Patterns use a non-illuminated hub (**H**) see page 5 for more information and availability. For patterns Specify pattern shape and overall nominal dimensions. Example: HL6x4: L Hub pattern that is 6'x4'. <sup>3</sup>Specify CAC length, standard CAC is 48". Specify grid: **G1**=15/16", **G9**=9/16", **GS**=Screw Slot. Example: CAC48G1. <sup>4</sup>Enter total quantity for Battery/Emergency for continuous runs, Example **2PLL**. <sup>5</sup>**RT** allows aiming for individual fixtures and straight runs, **RT** is not available with patterns. Closed patterns, such as squares, include built-in rotational aiming capability. Specifications and dimensions subject to change without notice. Specification sheets that appear on pinnacle-ltg.com are the most recent version and supersede all other previously printed or electronic versions.



Series

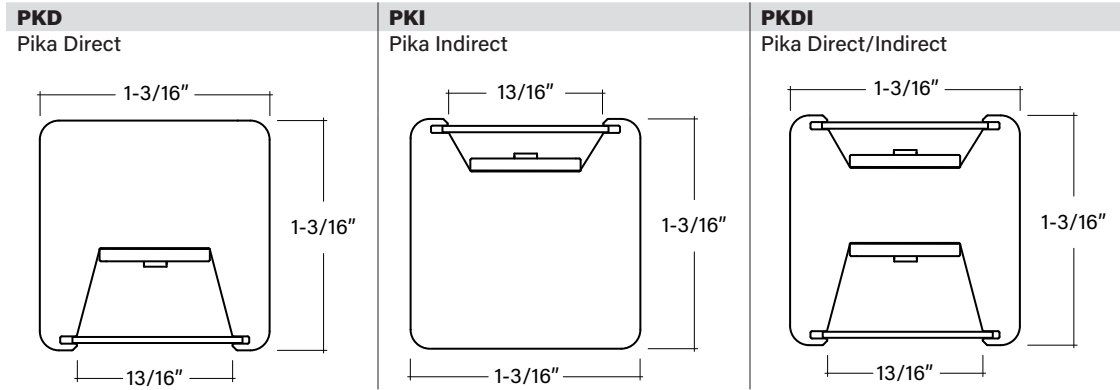

Shielding

- Specify direct and/or indirect shielding as applicable to the fixture type selected (**PKD**, **PKI**, or **PKDI**). Use **N** - None for any unused side.
- All lensed shielding, other than A lens, is supplied in maximum 4' lengths; multiple lenses are provided for units >4'.

**DIRECT**

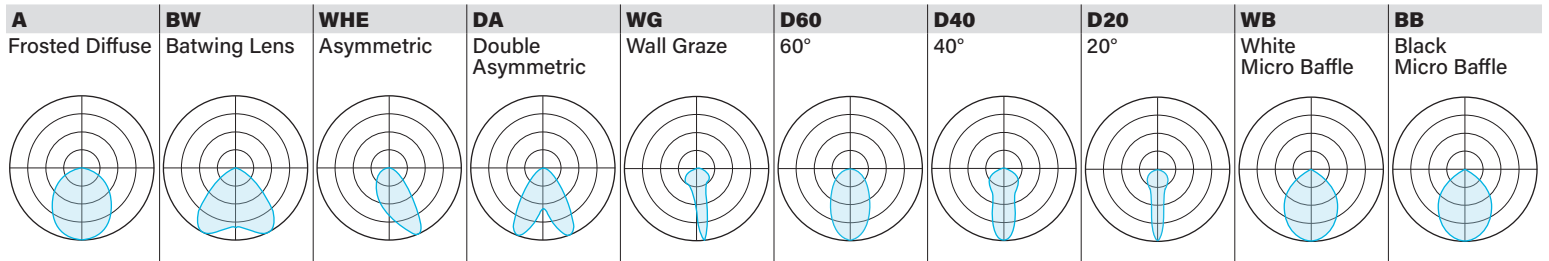

**INDIRECT**

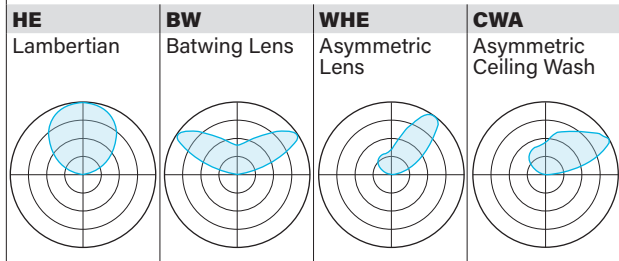

Specifications and dimensions subject to change without notice. Specification sheets that appear on pinnacle-ltg.com are the most recent version and supersede all other previously printed or electronic versions.



**Direct Source**

- Specify either 80 or 90 CRI
- Longer lead-time may apply for 90 CRI. Consult factory.
- 90 CRI = R9≥50
- Not all lumen package combinations can be accommodated, consult factory for more information.
- Higher lumen outputs available for some configurations, consult factory for more information.

**Custom Output - Lumens OR Wattage**

<b>CL</b> _____	Specify CRI, CCT and desired lumens (i.e. CL835600)	Specify lumens between standard offering listed below. Lumens are specified per color temp
<b>CW</b> _____	Specify CRI, CCT and desired wattage (i.e. CW9407)	Specify lumens between standard offering listed below. Lumens are specified per color temp

**Direct 80 CRI**

	Color	LMS per foot	Shielding																			
			A Fosted Diffuse		BW Batwing		WHE Asymmetric		DA Double Asym.		WG Wall Graze		D60 60°		D40 40°		D20 20°		BB Black Baffle		WB White Baffle	
			LPW	Watts/ft	LPW	Watts/ft	LPW	Watts/ft	LPW	Watts/ft	LPW	Watts/ft	LPW	Watts/ft	LPW	Watts/ft	LPW	Watts/ft	LPW	Watts/ft	LPW	Watts/ft
<b>830LO</b>	3000K	250	140	1.8	150	1.7	149	1.7	149	1.7	151	1.7	149	1.7	150	1.7	148	1.7	56	4.5	100	2.5
<b>830MO</b>		500	143	3.5	154	3.3	152	3.3	153	3.3	155	3.2	153	3.3	154	3.3	152	3.3	55*	9.1*	99	5.1
<b>830HO</b>		750	140	5.4	150	5.0	149	5.0	149	5.0	151	5.0	149	5.0	150	5.0	148	5.1	N/A		97	7.7
<b>830VHO</b>		1000	137	7.3	148	6.7	147	6.8	148	6.8	150	6.7	148	6.8	149	6.7	147	6.8	N/A		96*	10.4*
<b>835LO</b>	3500K	250	143	1.7	153	1.6	152	1.6	153	1.6	155	1.6	153	1.6	154	1.6	152	1.6	57	4.4	102	2.4
<b>835MO</b>		500	146	3.4	155	3.2	156	3.2	156	3.2	157	3.2	156	3.2	156	3.2	156	3.2	56*	8.9*	101	4.9
<b>835HO</b>		750	143	5.2	154	4.9	152	4.9	153	4.9	155	4.8	153	4.9	154	4.9	152	4.9	N/A		99	7.5
<b>835VHO</b>		1000	141	7.1	152	6.6	151	6.6	151	6.6	153	6.5	151	6.6	152	6.6	150	6.6	N/A		99*	10.1*
<b>840LO</b>	4000K	250	146	1.7	157	1.6	155	1.6	156	1.6	158	1.6	156	1.6	157	1.6	155	1.6	59	4.3	105	2.4
<b>840MO</b>		500	149	3.3	159	3.1	157	3.2	158	3.2	160	3.1	158	3.2	159	3.1	157	3.2	57*	8.8*	104	4.8
<b>840HO</b>		750	146	5.1	157	4.8	156	4.8	156	4.8	158	4.7	156	4.8	158	4.8	156	4.8	N/A		102	7.4
<b>840VHO</b>		1000	144	6.9	156	6.4	154	6.5	155	6.5	157	6.4	155	6.5	156	6.4	154	6.5	N/A		101*	9.9*

**Direct 90 CRI**

<b>927LO</b>	2700K	250	113	2.2	121	2.1	120	2.1	121	2.1	122	2.0	121	2.1	122	2.1	120	2.1	45	5.6	81	3.1
<b>927MO</b>		500	113	4.4	123	4.1	122	4.1	123	4.1	124	4.0	122	4.1	123	4.1	122	4.1	N/A		79	6.3
<b>927HO</b>		750	111	6.8	120	6.3	119	6.3	119	6.3	121	6.2	119	6.3	120	6.2	119	6.3	N/A		78*	9.7*
<b>927VHO</b>		1000	110*	9.1*	118	8.5	117	8.6	117	8.5	119	8.4	117	8.5	118	8.5	117	8.6	N/A		N/A	
<b>930LO</b>	3000K	250	119	2.1	127	2.0	126	2.0	127	2.0	128	1.9	127	2.0	128	2.0	126	2.0	47	5.3	85	3.0
<b>930MO</b>		500	119	4.2	129	3.9	128	3.9	129	3.9	131	3.8	129	3.9	130	3.9	128	3.9	N/A		83	6.0
<b>930HO</b>		750	117	6.4	126	5.9	125	6.0	126	6.0	127	5.9	126	6.0	127	5.9	125	6.0	N/A		82*	9.2*
<b>930VHO</b>		1000	115*	8.7*	124	8.1	123	8.1	124	8.1	125	8.0	123	8.1	124	8.0	123	8.1	N/A		N/A	
<b>935LO</b>	3500K	250	121	2.1	130	1.9	128	1.9	129	1.9	131	1.9	129	1.9	130	1.9	128	1.9	48	5.2	86	2.9
<b>935MO</b>		500	123	4.1	132	3.8	131	3.8	131	3.8	133	3.8	131	3.8	132	3.8	130	3.8	N/A		85	5.9
<b>935HO</b>		750	119	6.3	129	5.8	128	5.9	128	5.8	130	5.8	128	5.9	129	5.8	127	5.9	N/A		83*	9.0*
<b>935VHO</b>		1000	117	8.5	127	7.9	125	8.0	126	7.9	128	7.8	126	7.9	127	7.9	125	8.0	N/A		N/A	
<b>940LO</b>	4000K	250	126	2.0	135	1.9	134	1.9	134	1.9	136	1.8	134	1.9	135	1.9	133	1.9	50	5.0	90	2.8
<b>940MO</b>		500	128	3.9	137	3.6	136	3.7	137	3.7	138	3.6	137	3.7	138	3.6	136	3.7	49	10.2	88	5.7
<b>940HO</b>		750	125	6.0	134	5.6	133	5.6	134	5.6	135	5.5	133	5.6	135	5.6	133	5.6	N/A		86*	8.7*
<b>940VHO</b>		1000	122	8.2	132	7.6	131	7.6	132	7.6	133	7.5	131	7.6	132	7.6	131	7.7	N/A		N/A	

\* Indicates output only available with Pika Direct Series **PDK**.



### Indirect Source

- Specify either 80 or 90 CRI
- Longer lead-time may apply for 90 CRI. Consult factory.
- 90 CRI = R9≥50
- Not all lumen package combinations can be accommodated, consult factory for more information.
- Higher lumen outputs available for some configurations, consult factory for more information.

### Custom Output - Lumens OR Wattage

**CL** \_\_\_\_\_ Specify CRI, CCT and desired lumens (i.e. CL835600) *Specify lumens between standard offering listed below. Lumens are specified per color temp*

**CW** \_\_\_\_\_ Specify CRI, CCT and desired wattage (i.e. CW9407) *Specify lumens between standard offering listed below. Lumens are specified per color temp*

### Indirect 80 CRI

	Color	LMS per foot	Shielding							
			HE		BW		WHE		CWA	
			Lambertian		Batwing		Asymmetric		Ceiling Wash	
			LPW	Watts/ft	LPW	Watts/ft	LPW	Watts/ft	LPW	Watts/ft
<b>830LO</b>	3000K	250	161	1.6	144	1.7	78	3.2	104	2.4
<b>830</b>		500	163	3.1	147	3.4	76	6.5	103	4.9
<b>830HO</b>		750	161	4.6	144	5.2	N/A		101	7.4
<b>830VHO</b>		1000	160	6.3	142	7.0	N/A		N/A	
<b>835LO</b>	3500K	250	164	1.5	147	1.7	80	3.1	106	2.4
<b>835</b>		500	167	3.0	151	3.3	78	6.4	105	4.8
<b>835HO</b>		750	165	4.5	147	5.1	N/A		104	7.2
<b>835VHO</b>		1000	164	6.1	146	6.9	N/A		N/A	
<b>840LO</b>	4000K	250	168	1.5	151	1.7	82	3.1	109	2.3
<b>840</b>		500	170	2.9	154	3.2	80	6.2	108	4.6
<b>840HO</b>		750	169	4.4	151	5.0	N/A		106	7.1
<b>840VHO</b>		1000	168	6.0	149	6.7	N/A		N/A	

### Indirect 90 CRI

<b>927LO</b>	2700K	250	130	1.9	116	2.1	63	3.9	84	3.0
<b>927</b>		500	132	3.8	116	4.3	N/A		82	6.1
<b>927HO</b>		750	129	5.8	115	6.5	N/A		N/A	
<b>927VHO</b>		1000	127	7.9	N/A		N/A		N/A	
<b>930LO</b>	3000K	250	136	1.8	122	2.0	67	3.8	88	2.8
<b>930</b>		500	139	3.6	124	4.0	64	7.8	87	5.8
<b>930HO</b>		750	136	5.5	121	6.2	N/A		N/A	
<b>930VHO</b>		1000	134	7.5	N/A		N/A		N/A	
<b>935LO</b>	3500K	250	139	1.8	124	2.0	68	3.7	89	2.8
<b>935</b>		500	142	3.5	126	4.0	65	7.7	88	5.7
<b>935HO</b>		750	139	5.4	123	6.1	N/A		N/A	
<b>935VHO</b>		1000	136	7.3	N/A		N/A		N/A	
<b>940LO</b>	4000K	250	144	1.7	129	1.9	71	3.5	93	2.7
<b>940</b>		500	148	3.4	132	3.8	68	7.3	92	5.4
<b>940HO</b>		750	145	5.2	129	5.8	N/A		N/A	
<b>940VHO</b>		1000	142	7.0	N/A		N/A		N/A	

Specifications and dimensions subject to change without notice. Specification sheets that appear on pinnacle-ltg.com are the most recent version and supersede all other previously printed or electronic versions.



## Length

- All individual units cannot be joined, endcaps are factory installed and cannot be removed
- For Continuous runs, add 1/2" (12.7mm) for each endcap or 1" (24.5mm) to the overall length of the row
- When using the Rotational Endcap (RE) options add 1-1/2" (38.1mm) for each endcap and add 1-3/4" (44.5mm) for each joint when using continuous runs

2	3	4	5	6	7	8	—
Indiv. Fixture	Indiv. Fixture	Indiv. Fixture	Indiv. Fixture	Indiv. Fixture	Indiv. Fixture	Indiv. Fixture	Cont. Run Specify nominal overall row length in 1 foot increments
24" (609.6mm)		36" (914.4mm)			48" (1219.2mm)		
60" (1524mm)				72" (1828.8mm)			
84" (2133.6mm)						96" (2438.4mm)	
Specify to the 1' >>>							

## Pattern - Micro Hubs

- Specify pattern shape and dimensions per leg(s)
- Length specified will not reflect overall pattern dimensions
- Shapes not shown require MOD Pattern; consult factory

HS_	HR_x_	HU_x_x_	HL_x_	HH_	HT_x_	HY_x_	HX_x_	MOD
Square Hub Provide A dimension Example: HS4	Rectangle Hub Provide AxB dimensions Example: HR4x2	U-Shape Hub Provide AxBxC dimensions Example: HU3x4x3	L-Shape Hub Provide AxB dimensions Example: HL3x3	Hexagon Hub Provide A dimension Example: HH4	T-Shape Hub Provide AxBxC dimensions Example: HT3x5x3	Y-Shape Hub Provide AxBxC dimensions Example: HY3x3x3	X-Shape Hub Provide AxBxCxD dimensions Example: X3x3x3x3	MOD Factory drawing and sign-off required for all MOD patterns

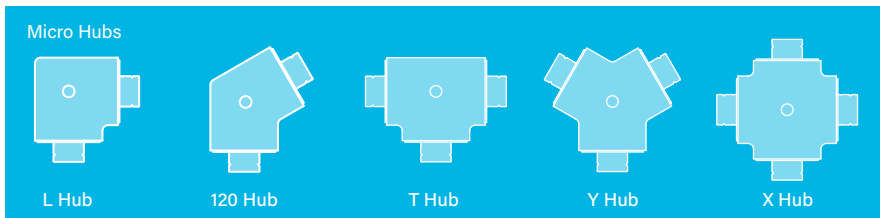

## Mounting

- CAC is a small-diameter powered suspension cable that combines power and suspension in one assembly. Each cable includes four conductors
- Adjustable power cable. Specify 48", 120", or 240" length in ordering code (CAC48JB)
- Endcaps and power cable attached at factory and cannot be removed
- Approved for dry/damp location unless otherwise noted
- Refer to installation instructions during installation
- Maximum fixture weight is 2.2 lbs for a standard 4' fixture

<b>CAC_G1</b>	Power Cable Suspension to Grid, 1" (15/16") T-Bar
<b>CAC_G9</b>	Power Cable Suspension to Grid, 9/16" T-Bar
<b>CAC_GS</b>	Power Cable Suspension to Grid, Screw Slot T-Bar
<b>CAC_JB</b>	Power Cable Suspension to Junction Box or Structure

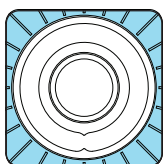
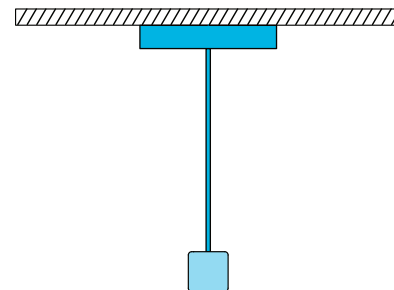

Fixture Aiming  
Aiming marks in 15° increments for 345° rotation

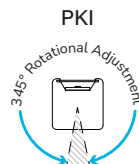
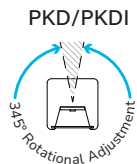



## Voltage

- Some PIKA configurations will not accommodate all voltage options; consult with factory

<b>U</b>	Universal
<b>1</b>	120 volt
<b>2</b>	277 volt
<b>3</b>	347 volt

## Driver

- ALL DRIVER OPTIONS ARE REMOTE
- 1 driver box provided per fixture unless otherwise noted
- Slim remote box is for single driver, Standard Remote Box is used 2 drivers, and driver with battery
- For more driver options, see Pinnacle Resource Guide
- Some PIKA configurations will not accommodate all driver options; consult with factory

- FSD, eldoLED and Advance Drivers have an average remote distance limitation of 50' or greater. See table on pg 9
- Lutron Drivers have a remote distance limitation of 10'
- Default remote box is plenum-rated and supplied with grid clips and 6' flex whip for connection to a junction box (by others). Optional decorative remote box available for surface-mount and open structure ceiling conditions; see fixture options

### 0-10V Drivers

<b>FSD</b>	Factory Select Driver 1%, 0-10v
<b>PL2</b>	Advance Xitanium 1%, 0-10v
<b>PL4</b>	Advance Xitanium 347v 1%, 0-10v, requires 347v option
<b>OL2</b>	eldoLED Optotronic, 1%, 0-10v
<b>OL4</b>	eldoLED Optotronic 347v, 1% 0-10v, requires 347v option
<b>EE1</b>	eldoLED ECOdrive 1%, 0-10v, Logarithmic
<b>EE2</b>	eldoLED ECOdrive 1%, 0-10v, Linear
<b>ES1</b>	eldoLED SOLOdrive 0.1%, 0-10v, Logarithmic
<b>ES2</b>	eldoLED SOLOdrive 0.1%, 0-10v, Linear

### DALI Drivers

<b>EE3</b>	eldoLED ECOdrive 1%, DALI 2, Logarithmic, DT6
<b>ES3</b>	eldoLED SOLOdrive 0.1%, DALI 2, Logarithmic, DT6

### Lutron Drivers

<b>LH1</b>	Lutron Hi-lume Soft-on, Fade-to-black 1%, EcoSystem, LDE1
------------	---

Slim Remote Box

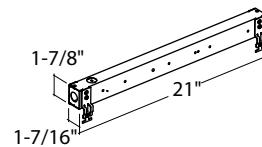

Standard Remote Box

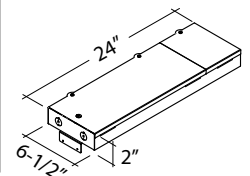

## How to specify Circuiting, Battery and Emergency

- Select fixture circuiting from options below
  - Some PIKA configurations will not accommodate all circuiting options, consult with factory

## Circuiting

<b>1</b>	Single Circuit
<b>2</b>	Dual Circuit (independent direct/indirect)
<b>E</b>	Emergency Circuit only

- Battery and emergency options are available in addition to fixture circuit
  - Full housing required for battery and emergency options
  - Select battery and emergency options below; factory shop drawing required
  - Some PIKA configurations will not accommodate all circuiting options, consult with factory

## Battery and/or Emergency If Required

<b>0</b>	No battery or specific emergency required
----------	---



## Battery

- Battery will be remote mounted with driver and requires standard remote box
- Select battery type if required, indicate total QTY. *Example 2PLL*
- 90 minute battery runtime; test button is remote to fixture and requires an additional drop
- Battery operates full length of housing up to 8' on individual fixtures or within continuous row
- For more battery options available, see Pinnacle Resource Guide

<b>0</b>	No Battery
<b>_FSB</b>	Factory Select 10w Lithium
<b>_FSBST</b>	Factory Select 10w Lithium, Self Testing
<b>_PLL</b>	Bodine 10w Lithium, Self Testing
<b>_ILL</b>	Iota 10w Integral Lithium, Self Testing

### For Approximate Battery Lumen Output

- Multiply battery wattage X fixture LPW shown on Lumen Table
- $120 \text{ (LPW)} \times 10 \text{ (watts)} = 1200 \text{ battery lumen output}$

### Battery OR Emergency Ordering Examples

- Single circuit, 10w Integral Battery      Ordering Code: 1-1FSB
- Emergency only, 10w Integral Battery      Ordering Code: E-1PLL

## Emergency

- Select emergency type if required, indicate total QTY. *Example 1FSG*
- Combine battery and emergency ordering codes if both options are selected

<b>_FSG</b>	Factory Select ALCR Emergency Control Device, UNV
-------------	---

## Finish

- Standard powder-coat textured white, textured black, or matte aluminum finish; consult factory for chip of standard finishes
- Selecting a fixture finish other than white may impact lumen output; consult factory for more information

<b>W</b>	White ( <i>white cord/white canopy</i> )
<b>BL</b>	Textured Black ( <i>black cord/black canopy</i> )
<b>AL</b>	Matte Aluminum ( <i>white cord/matte aluminum canopy</i> )
<b>CC</b>	Custom Color ( <i>white cord/color match canopy</i> )

## Endcap

- Rotational Endcap - **RT**, is not available with any hubs
- When closed patterns are selected no endcap options are available

<b>FE</b>	Flat Endcap (default)
<b>RT</b>	Rotational Endcap - allows aiming of suspended fixtures
<b>RE</b>	Rounded Endcap
<b>AW</b>	Flat Endcap with White Accent
<b>ABK</b>	Flat Endcap with Black Accent
<b>ACA</b>	Flat Endcap with Anodized Clear Accent
<b>AGD</b>	Flat Endcap with Anodized Gold Accent

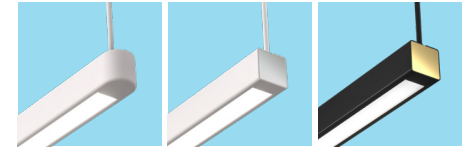

## Fixture Options

- Standard remote box has removable grid clips and can be used for both grid or surface mounting. Decorative remote box is only for surface mount and has flat cover plate.

<b>RBW</b>	Decorative Remote Box, White
<b>RBBK</b>	Decorative Remote Box, Black

Remote Box

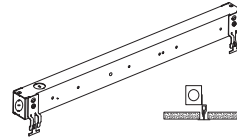

Decorative Remote Box

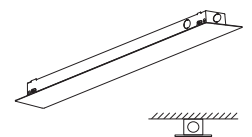

## Controls

- Pinnacle is able to accommodate different control solutions from different manufacturers. Consult Factory for more information.



## Photometrics

### Direct Batwing

Test #	KPL2015-192
Catalog #	PKD-BW-N-835VHO-4
Lumens	4011
Watts	26.74
Efficacy	150

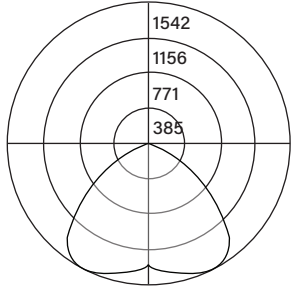

### Indirect Batwing

Test #	KPL2015-176
Catalog #	PKI-N-BW-835VHO-4
Lumens	4008
Watts	30.7
Efficacy	130

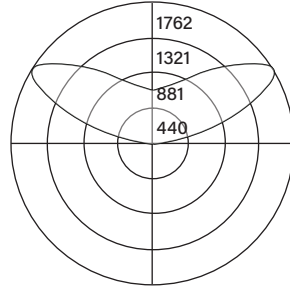

### Direct/Indirect Batwing

Test #	KPL2015-192 & KPL2015-176
Catalog #	PKDI-BW-BW-835VHO-835VHO-4
Lumens	7995
Watts	57.4
Efficacy	139.3

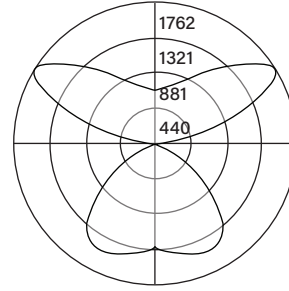

### Candela Distribution

Vert Angle	Horizontal Angle				
	0	22.5	45	67.5	90
0	1363	1363	1363	1363	1363
5	1336	1354	1369	1381	1397
10	1314	1343	1382	1413	1438
15	1277	1324	1397	1456	1489
20	1226	1297	1411	1499	1532
25	1162	1262	1419	1520	1542
30	1085	1217	1408	1501	1513
35	997	1158	1364	1427	1436
40	901	1083	1279	1290	1284
45	799	990	1151	1090	1042
50	693	879	988	848	772
55	587	753	795	620	540
60	481	616	600	438	380
65	378	475	428	307	275
70	279	343	285	212	196
75	185	221	172	137	129
80	101	117	87	77	74
85	34	38	34	34	34
90	2	2	1	1	1

### Candela Distribution

Vert Angle	Horizontal Angle				
	0	22.5	45	67.5	90
90	2	3	4	4	4
95	33	49	57	43	39
100	85	150	266	205	158
105	141	240	519	500	402
110	196	312	724	901	807
115	249	363	836	1284	1298
120	301	408	856	1491	1669
125	351	454	841	1488	1762
130	400	499	830	1383	1658
135	448	542	825	1260	1496
140	495	581	820	1151	1335
145	541	616	811	1057	1195
150	583	645	799	976	1074
155	620	669	783	905	972
160	653	688	765	844	887
165	680	702	749	792	817
170	699	711	736	754	766
175	711	717	727	730	735
180	720	720	720	720	720

### Candela Distribution

Vert Angle	Horizontal Angle				
	0	22.5	45	67.5	90
0	1363	1363	1363	1363	1363
5	1336	1354	1369	1381	1397
10	1314	1343	1382	1413	1438
15	1277	1324	1397	1456	1489
20	1226	1297	1411	1499	1532
25	1162	1262	1419	1520	1542
30	1085	1217	1408	1501	1513
35	997	1158	1364	1427	1436
40	901	1083	1279	1290	1284
45	799	990	1151	1090	1042
50	693	879	988	848	772
55	587	753	795	620	540
60	481	616	600	438	380
65	378	475	428	307	275
70	279	343	285	212	196
75	185	221	172	137	129
80	101	117	87	77	74
85	34	38	34	34	34
90	2	2	1	1	1

### Luminance Data (cd/sq.m)

Angle In Degrees	Average 0-Deg	Average 45-Deg	Average 90-Deg
45	37963	53915	49542
55	34394	46557	31613
65	30054	33687	21840
75	23960	22798	16803
85	13040	13279	13152

### Luminance Data (cd/sq.m)

Angle In Degrees	Average 0-Deg	Average 45-Deg	Average 90-Deg
45	37963	54723	49542
55	34394	46554	31613
65	30054	34035	21840
75	23960	22329	16803
85	13040	13064	13152

For all available IES files, please visit our website at [pinnacle-ltg.com](http://pinnacle-ltg.com). Photometry testing in accordance to IESNA-LM-79-08 at an NVLAP or IAS accredited testing laboratory. Testing conducted at 25°C ambient conditions

Specifications and dimensions subject to change without notice. Specification sheets that appear on [pinnacle-ltg.com](http://pinnacle-ltg.com) are the most recent version and supersede all other previously printed or electronic versions.

Designed in Denver, CO • USA | [pinnacle-ltg.com](http://pinnacle-ltg.com) | O: 303-322-5570 F: 303-322-5568

PK\_SUSP\_SPECS\_MAY2026



## Applications & Certificates

**Construction:** Extruded aluminum housing with machined aluminum end caps and hubs. Highly reflective white reflector material optimizes luminaire efficiency.

**Shielding:** Lens options include frosted diffuse and nanostructured polycarbonate lenses for a range of optical distributions. Micro baffle features white or black injection-molded polycarbonate louvers with a frosted diffuse lens.

**Mounting:** Powered suspension cable with round 4-5/8" diameter ceiling canopy.

**Joining:** Magnetically aligned joining system provides secure alignment for continuous rows with an uninterrupted line of light. Straight micro hub used to join fixtures with RT rotational aiming option.

**LED:** 25°C test environment. Lumen output/wattage has a margin of +/- 5%; 2' or 3' lengths may have a greater wattage deviation. Luminaire configurations tested in accordance with IES LM-79. Diodes tested in accordance with IES LM-80. Lifetime calculated using IES TM-21. Minimum lifetime greater than 60,000 hours. Lifetime Projection L70 = 254,800 hours and L90 = 80,200 hours. MacAdam 3-Step Ellipses. For all available IES files, please visit our website at [pinnacle-ltg.com](http://pinnacle-ltg.com).

**CRI, CCT & Output:** Not all lumen packages available. Four standard lumen packages available. Low (LO), Medium (MO), High (HO) and Very High (VHO). Custom outputs are available. Specify custom lumens or watts between standard offering listed on CRI, CCT & Output page. 80 CRI is available for 3000K, 3500K, and 4000K. 90 CRI is available for 2700K, 3000K, 3500K and 4000K. 90 CRI = R9≥50.

**Voltage:** Universal (U), 120 volt (1), 277 volt (2) and 347 volt (3) options available. Must specify PL4 or OL4 in Driver section when 347 volt (3) is selected. Some configurations will not accommodate all voltage options; consult with factory.

**Driver:** Standard Driver option is Factory Selected Driver 0-10V, 1% = FSD. Electronic driver, Power factor is >0.9 with a THD <20%. Driver Lifetime: 50,000 hours at 25°C ambient operating conditions. For more driver options, see Pinnacle Resource Guide. Some configurations will not accommodate all driver options.

### Remote Mounting Guide

*Distance limited by max input watts shown.*

	4w/ft	6w/ft	8w/ft	10w/ft
4' or less Suspension Drop	16 AWG - 126ft	16 AWG - 79ft	16 AWG - 55ft	16 AWG - 41ft

Contact factory for other suspension lengths or wire gauge recommendations

**Circuiting:** Select from single circuit (1), dual circuit (2) or Emergency circuit (E). Some configurations will not accommodate all circuiting options; consult with factory.

**Battery & Emergency:** Select battery or emergency options if required. If battery or emergency option is not required, enter 0. Battery duration is 90 minutes as standard. Test button is remote to fixture. For more Battery options, see Pinnacle Resource Guide.

**Finish:** Standard powder-coat textured white, matte aluminum or textured black painted finish; consult factory for chip of standard paint finishes. Contact factory for additional custom color and finish options.

**Controls:** MOD options available, consult with factory.

**Labels:** UL and cUL 1598 listed. Approved for dry/damp location unless otherwise noted.

**Fixture Weight:** Maximum fixture weight is 2.2 lbs for a standard 4' fixture.

**Warranty:** PIKA offered with a 5-year limited warranty. Covers LED, driver and fixture.