

PIKA

Arm Mount
Micro Linear

Key Features

- Compact micro-linear family in direct, indirect, and direct/indirect
- A versatile mix of optical distributions for shaping light with intent
- Micro baffle options in white or black for added visual comfort
- Remote driver architecture supports Pika's remarkably small profile
- Rotational aiming with discrete angle marks and locking screws



Example Part #: PKD-WB-N-830HO-N-6'-WA6-U-FSD-1-0-W

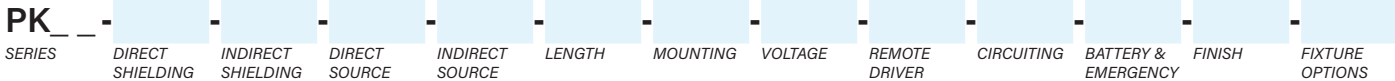

PK__	---	---	-----
SERIES	DIRECT SHIELDING	INDIRECT SHIELDING	DIRECT SOURCE ¹
PKD - Pika Direct PKI - Pika Indirect PKDI - Pika Direct/Indirect <i>Housing pg. 2</i>	A - Frosted Diffuse BW - Batwing WHE - Asymmetric DA - Double Asymmetric WG - Wall Graze <i>Shielding pg. 2</i>	D60 - 60° D40 - 40° D20 - 20° WB - White Micro Baffle BB - Black Micro Baffle N - None	HE - Lambertian BW - Batwing Lens WHE - Asymmetric Lens CWA - Asymmetric Ceiling Wash N - None <i>Shielding pg. 2</i>
			27 - 2700K LO - 250 lms/ft _30_ - 3000K MO - 500 lms/ft _35_ - 3500K HO - 750 lms/ft _40_ - 4000K VHO - 1000 lms/ft CL _____ - Custom Lumens CW _____ - Custom Watts N - None <i>Source pg. 2-3</i>

-----	-----	-----	-	---
INDIRECT SOURCE ¹	LENGTH ²	MOUNTING ³	VOLTAGE	REMOTE DRIVER
27 - 2700K LO - 250 lms/ft _30_ - 3000K MO - 500 lms/ft _35_ - 3500K HO - 750 lms/ft _40_ - 4000K VHO - 1000 lms/ft CL _____ - Custom Lumens CW _____ - Custom Watts N - None <i>Source pg. 2-3</i>	___ - Individual Fixture ___ - Continuous Row <i>Length pg. 3</i>	WA ___ - Wall Arm Mount PA ___ - Ceiling Pendant Arm <i>Mounting pg. 4</i>	U - Universal (120 thru 277V) 1 - 120V 2 - 277V 3 - 347V <i>Voltage pg. 4</i>	FSD - Factory Select Driver (1%, 0-10v) PL2 - Advance Xitanium (1%, 0-10v) OL2 - eldoLED Optotronic (1%, 0-10v) OL4 - eldoLED Optotronic 347v (1%, 0-10v) EE1 - eldoLED ECOdrive (1%, 0-10v) ES1 - eldoLED SOLOdrive (0.1%, 0-10v) LH1 - Lutron Hi-Lume (1%, EcoSystem) <i>Remote Driver pg. 4</i>

-	---	--	--
CIRCUITING	BATTERY & EMERGENCY ⁴	FINISH	FIXTURE OPTIONS
1 - Single Circuit 2 - Dual Circuit (direct/indirect) E - Emergency (entire fixture) <i>Circuiting pg. 5</i>	0 - None _FSB - Factory Select Battery _FSG - Factory Select ALCR _ILL - Iota 10w _PLL - Bodine 10w <i>Battery & Emergency pg. 5</i>	W - White BL - Textured Black AL - Matte Aluminum CC - Custom Color Powder Coat <i>Finish pg. 5</i>	RBW - Decorative Remote Box, White RBB - Decorative Remote Box, Black <i>Fixture Options pg. 5</i>

¹When specifying CRI- CCT & OUTPUT the first ___ is for specifying either **8** - 80CRI or **9** - 90CRI. The ending ___ are for specifying output, example **HO** - High Output. See output charts for more information. ²Individual fixtures come in **2', 3', 4', 5', 6', 7', & 8'** lengths. Continuous row come in 1' increments. ³Specify arm length, standard arm length comes as either 3', 6', 12', 18" or 24". Example: **WA18**. ⁴Enter total quantity of Battery/Emergency for continuous runs, Example **2PLL**.

Specifications and dimensions subject to change without notice. Specification sheets that appear on pinnacle-ltg.com are the most recent version and supersede all other previously printed or electronic versions.



Series

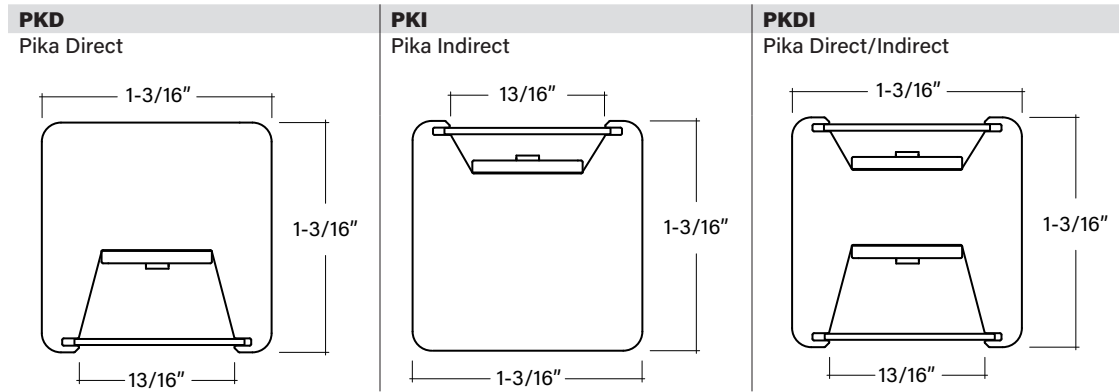

Shielding

- Specify direct and/or indirect shielding as applicable to the fixture type selected (**PKD**, **PKI**, or **PKDI**). Use **N** - None for any unused side.
- All lensed shielding, other than **A** lens, is supplied in maximum 4' lengths; multiple lenses are provided for units >4'.

DIRECT

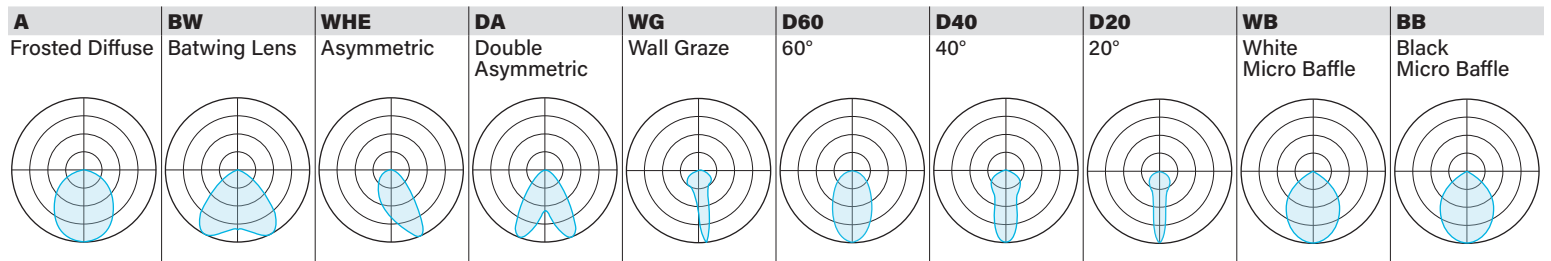

INDIRECT

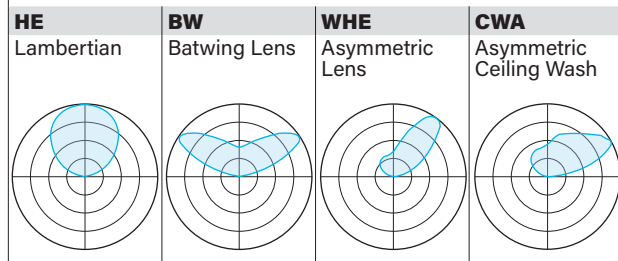

Specifications and dimensions subject to change without notice. Specification sheets that appear on pinnacle-ltg.com are the most recent version and supersede all other previously printed or electronic versions.



Direct Source

- Specify either 80 or 90 CRI
- Longer lead-time may apply for 90 CRI. Consult factory.
- 90 CRI = R9≥50
- Not all lumen package combinations can be accommodated, consult factory for more information.
- Higher lumen outputs available for some configurations, consult factory for more information.

Custom Output - Lumens OR Wattage

CL _____	Specify CRI, CCT and desired lumens (i.e. CL835600)	Specify lumens between standard offering listed below. Lumens are specified per color temp
CW _____	Specify CRI, CCT and desired wattage (i.e. CW9407)	Specify lumens between standard offering listed below. Lumens are specified per color temp

Direct 80 CRI

	Color	LMS per foot	Shielding		WHE		DA		WG		D60		D40		D20		BB		WB			
			A		BW		Asymmetric		Double Asym.		Wall Graze		60°		40°		20°		Black Baffle		White Baffle	
			Fosted	Diffuse	Batwing		LPW	Watts/ft	LPW	Watts/ft	LPW	Watts/ft	LPW	Watts/ft	LPW	Watts/ft	LPW	Watts/ft	LPW	Watts/ft	LPW	Watts/ft
830LO	3000K	250	140	1.8	150	1.7	149	1.7	149	1.7	151	1.7	149	1.7	150	1.7	148	1.7	56	4.5	100	2.5
830MO		500	143	3.5	154	3.3	152	3.3	153	3.3	155	3.2	153	3.3	154	3.3	152	3.3	55*	9.1*	99	5.1
830HO		750	140	5.4	150	5.0	149	5.0	149	5.0	151	5.0	149	5.0	150	5.0	148	5.1	N/A		97	7.7
830VHO		1000	137	7.3	148	6.7	147	6.8	148	6.8	150	6.7	148	6.8	149	6.7	147	6.8	N/A		96*	10.4*
835LO	3500K	250	143	1.7	153	1.6	152	1.6	153	1.6	155	1.6	153	1.6	154	1.6	152	1.6	57	4.4	102	2.4
835MO		500	146	3.4	155	3.2	156	3.2	156	3.2	157	3.2	156	3.2	156	3.2	156	3.2	56*	8.9*	101	4.9
835HO		750	143	5.2	154	4.9	152	4.9	153	4.9	155	4.8	153	4.9	154	4.9	152	4.9	N/A		99	7.5
835VHO		1000	141	7.1	152	6.6	151	6.6	151	6.6	153	6.5	151	6.6	152	6.6	150	6.6	N/A		99*	10.1*
840LO	4000K	250	146	1.7	157	1.6	155	1.6	156	1.6	158	1.6	156	1.6	157	1.6	155	1.6	59	4.3	105	2.4
840MO		500	149	3.3	159	3.1	157	3.2	158	3.2	160	3.1	158	3.2	159	3.1	157	3.2	57*	8.8*	104	4.8
840HO		750	146	5.1	157	4.8	156	4.8	156	4.8	158	4.7	156	4.8	158	4.8	156	4.8	N/A		102	7.4
840VHO		1000	144	6.9	156	6.4	154	6.5	155	6.5	157	6.4	155	6.5	156	6.4	154	6.5	N/A		101*	9.9*

Direct 90 CRI

927LO	2700K	250	113	2.2	121	2.1	120	2.1	121	2.1	122	2.0	121	2.1	122	2.1	120	2.1	45	5.6	81	3.1
927MO		500	113	4.4	123	4.1	122	4.1	123	4.1	124	4.0	122	4.1	123	4.1	122	4.1	N/A		79	6.3
927HO		750	111	6.8	120	6.3	119	6.3	119	6.3	121	6.2	119	6.3	120	6.2	119	6.3	N/A		78*	9.7*
927VHO		1000	110*	9.1*	118	8.5	117	8.6	117	8.5	119	8.4	117	8.5	118	8.5	117	8.6	N/A		N/A	
930LO	3000K	250	119	2.1	127	2.0	126	2.0	127	2.0	128	1.9	127	2.0	128	2.0	126	2.0	47	5.3	85	3.0
930MO		500	119	4.2	129	3.9	128	3.9	129	3.9	131	3.8	129	3.9	130	3.9	128	3.9	N/A		83	6.0
930HO		750	117	6.4	126	5.9	125	6.0	126	6.0	127	5.9	126	6.0	127	5.9	125	6.0	N/A		82*	9.2*
930VHO		1000	115*	8.7*	124	8.1	123	8.1	124	8.1	125	8.0	123	8.1	124	8.0	123	8.1	N/A		N/A	
935LO	3500K	250	121	2.1	130	1.9	128	1.9	129	1.9	131	1.9	129	1.9	130	1.9	128	1.9	48	5.2	86	2.9
935MO		500	123	4.1	132	3.8	131	3.8	131	3.8	133	3.8	131	3.8	132	3.8	130	3.8	N/A		85	5.9
935HO		750	119	6.3	129	5.8	128	5.9	128	5.8	130	5.8	128	5.9	129	5.8	127	5.9	N/A		83*	9.0*
935VHO		1000	117	8.5	127	7.9	125	8.0	126	7.9	128	7.8	126	7.9	127	7.9	125	8.0	N/A		N/A	
940LO	4000K	250	126	2.0	135	1.9	134	1.9	134	1.9	136	1.8	134	1.9	135	1.9	133	1.9	50	5.0	90	2.8
940MO		500	128	3.9	137	3.6	136	3.7	137	3.7	138	3.6	137	3.7	138	3.6	136	3.7	49	10.2	88	5.7
940HO		750	125	6.0	134	5.6	133	5.6	134	5.6	135	5.5	133	5.6	135	5.6	133	5.6	N/A		86*	8.7*
940VHO		1000	122	8.2	132	7.6	131	7.6	132	7.6	133	7.5	131	7.6	132	7.6	131	7.7	N/A		N/A	

* Indicates output only available with Pika Direct Series PDK.



Indirect Source

- Specify either 80 or 90 CRI
- Longer lead-time may apply for 90 CRI. Consult factory.
- 90 CRI = R9≥50
- Not all lumen package combinations can be accommodated, consult factory for more information.
- Higher lumen outputs available for some configurations, consult factory for more information.

Custom Output - Lumens OR Wattage

CL _____ Specify CRI, CCT and desired lumens (i.e. CL835600) *Specify lumens between standard offering listed below. Lumens are specified per color temp*

CW _____ Specify CRI, CCT and desired wattage (i.e. CW9407) *Specify lumens between standard offering listed below. Lumens are specified per color temp*

Indirect 80 CRI

	Color	LMS per foot	Shielding							
			HE		BW		WHE		CWA	
			Lambertian		Batwing		Asymmetric		Ceiling Wash	
			LPW	Watts/ft	LPW	Watts/ft	LPW	Watts/ft	LPW	Watts/ft
830LO	3000K	250	161	1.6	144	1.7	78	3.2	104	2.4
830		500	163	3.1	147	3.4	76	6.5	103	4.9
830HO		750	161	4.6	144	5.2	N/A		101	7.4
830VHO		1000	160	6.3	142	7.0	N/A		N/A	
835LO	3500K	250	164	1.5	147	1.7	80	3.1	106	2.4
835		500	167	3.0	151	3.3	78	6.4	105	4.8
835HO		750	165	4.5	147	5.1	N/A		104	7.2
835VHO		1000	164	6.1	146	6.9	N/A		N/A	
840LO	4000K	250	168	1.5	151	1.7	82	3.1	109	2.3
840		500	170	2.9	154	3.2	80	6.2	108	4.6
840HO		750	169	4.4	151	5.0	N/A		106	7.1
840VHO		1000	168	6.0	149	6.7	N/A		N/A	

Indirect 90 CRI

927LO	2700K	250	130	1.9	116	2.1	63	3.9	84	3.0
927		500	132	3.8	116	4.3	N/A		82	6.1
927HO		750	129	5.8	115	6.5	N/A		N/A	
927VHO		1000	127	7.9	N/A		N/A		N/A	
930LO	3000K	250	136	1.8	122	2.0	67	3.8	88	2.8
930		500	139	3.6	124	4.0	64	7.8	87	5.8
930HO		750	136	5.5	121	6.2	N/A		N/A	
930VHO		1000	134	7.5	N/A		N/A		N/A	
935LO	3500K	250	139	1.8	124	2.0	68	3.7	89	2.8
935		500	142	3.5	126	4.0	65	7.7	88	5.7
935HO		750	139	5.4	123	6.1	N/A		N/A	
935VHO		1000	136	7.3	N/A		N/A		N/A	
940LO	4000K	250	144	1.7	129	1.9	71	3.5	93	2.7
940		500	148	3.4	132	3.8	68	7.3	92	5.4
940HO		750	145	5.2	129	5.8	N/A		N/A	
940VHO		1000	142	7.0	N/A		N/A		N/A	



Length

- All individual units cannot be joined, end plates are factory installed and cannot be removed
- For Continuous runs, add 7/8" (22.3mm) for each endcap to the overall length of the row and add 1-1/4" (32mm) for each joint.

2	3	4	5	6	7	8	–
Indiv. Fixture	Indiv. Fixture	Indiv. Fixture	Indiv. Fixture	Indiv. Fixture	Indiv. Fixture	Indiv. Fixture	Cont. Run
24" (609.6mm)							Specify nominal overall row length in 1 foot increments
	36" (914.4mm)						
		48" (1219.2mm)					
			60" (1524mm)				
				72" (1828.8mm)			
					84" (2133.6mm)		
						96" (2438.4mm)	
Specify to the 1' >>>							

Mounting

- Specify Arm length in ordering code (WA18)
- Arm lengths are 3", 6", 12", 18" or 24"
- Endcaps attached at factory and cannot be removed
- Canopies and mounts match fixture finish. See Finish section for additional details.

- Approved for dry/damp location unless otherwise noted
- Refer to installation instructions during installation
- Maximum fixture weight is 2.7 lbs for a standard 4' fixture

WA __	Wall Arm Mount
PA __	Ceiling Arm Mount

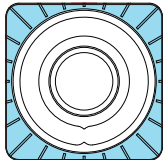
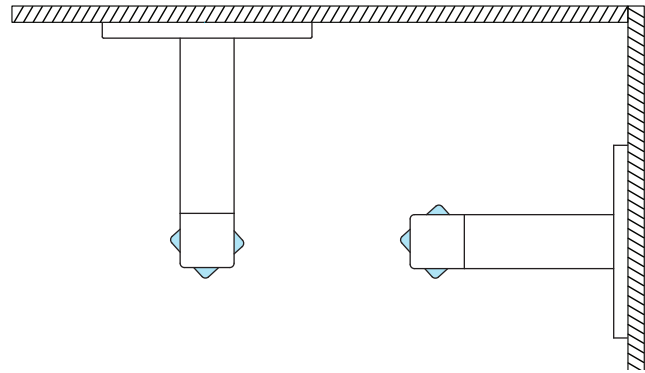

Fixture Aiming
Aiming marks in 15° increments for 345° rotation

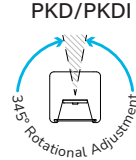

Voltage

- Some PIKA configurations will not accommodate all voltage options; consult with factory

U	Universal
1	120 volt
2	277 volt
3	347 volt



Driver

- ALL DRIVER OPTIONS ARE REMOTE
- 1 driver box provided per fixture unless otherwise noted
- Slim remote box is for single driver, Standard Remote Box is used 2 drivers, and driver with battery
- For more driver options, see Pinnacle Resource Guide
- Some PIKA configurations will not accommodate all driver options; consult with factory

- FSD, eldoLED and Advance Drivers have an average remote distance limitation of 90' or greater. See table on pg 9
- Lutron Drivers have a remote distance limitation of 10'
- Default remote box is plenum-rated and supplied with grid clips and 6' flex whip for connection to a junction box (by others). Optional decorative remote box available for surface-mount and open structure ceiling conditions; see fixture options

0-10V Drivers	
FSD	Factory Select Driver 1%, 0-10v
PL2	Advance Xitanium 1%, 0-10v
PL4	Advance Xitanium 347v 1%, 0-10v, requires 347v option
OL2	eldoLED Optotronic, 1%, 0-10v
OL4	eldoLED Optotronic 347v, 1% 0-10v, requires 347v option
EE1	eldoLED ECOdrive 1%, 0-10v, Logarithmic
EE2	eldoLED ECOdrive 1%, 0-10v, Linear
ES1	eldoLED SOLOdrive 0.1%, 0-10v, Logarithmic
ES2	eldoLED SOLOdrive 0.1%, 0-10v, Linear
DALI Drivers	
EE3	eldoLED ECOdrive 1%, DALI 2, Logarithmic, DT6
ES3	eldoLED SOLOdrive 0.1%, DALI 2, Logarithmic, DT6
Lutron Drivers	
LH1	Lutron Hi-lume Soft-on, Fade-to-black 1%, EcoSystem, LDE1

Slim Remote Box

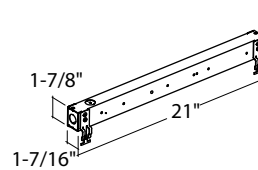

Standard Remote Box

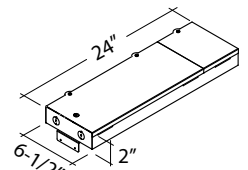

How to specify Circuiting, Battery and Emergency

- 1**
- Select fixture circuiting from options below
 - Some PIKA configurations will not accommodate all circuiting options, consult with factory

Circuiting

1	Single Circuit
2	Dual Circuit (independent up/down)
E	Emergency Circuit only

- 2** + **3**
- Battery and emergency options are available in addition to fixture circuit
 - Full housing required for battery and emergency options
 - Select battery and emergency options below; factory shop drawing required
 - Some PIKA configurations will not accommodate all circuiting options, consult with factory

Battery and/or Emergency If Required

- 0** No battery or specific emergency required



Battery

- Battery will be remote mounted with driver and requires standard remote box
- Select battery type if required, indicate total QTY. *Example 2PLL*
- 90 minute battery runtime; test button is remote to fixture and requires an additional drop
- Battery operates full length of housing up to 8' on individual fixtures or within continuous row
- For more battery options available, see Pinnacle Resource Guide

0	No Battery
_FSB	Factory Select 10w Lithium
_FSBST	Factory Select 10w Lithium, Self Testing
_PLL	Bodine 10w Lithium, Self Testing
_ILL	Iota 10w Integral Lithium, Self Testing

For Approximate Battery Lumen Output

- Multiply battery wattage X fixture LPW shown on Lumen Table
- $120 \text{ (LPW)} \times 10 \text{ (watts)} = 1200 \text{ battery lumen output}$

Emergency

- Select emergency section type if required, indicate total QTY. *Example 1FSG*
- Combine battery and emergency ordering codes if both options are selected

_FSG	Factory Select ALCR Emergency Control Device, UNV
-------------	---

Battery OR Emergency Ordering Examples

- Single circuit, 10w Integral Battery Ordering Code: 1-1FSB
- Emergency only, 10w Integral Battery Ordering Code: E-1PLL

Finish

- Standard powder-coat textured white, textured black, or matte aluminum finish; consult factory for chip of standard finishes
- Selecting a fixture finish other than white may impact lumen output; consult factory for more information

W	White (<i>white cord/white canopy</i>)
BL	Textured Black (<i>black cord/black canopy</i>)
AL	Matte Aluminum (<i>white cord/matte aluminum canopy</i>)
CC	Custom Color (<i>white cord/color match canopy</i>)

Fixture Options

- Standard remote box has removable grid clips and can be used for both grid or surface mounting. Decorative remote box is only for surface mount and has flat cover plate.

RBW	Decorative Remote Box, White
RBBK	Decorative Remote Box, Black

Remote Box

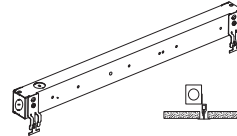

Decorative Remote Box

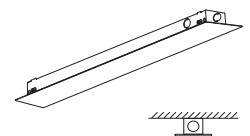

Controls

- Pinnacle is able to accommodate different control solutions from different manufacturers. Consult Factory for more information.



Photometrics

Direct Batwing

Test #	KPL2015-192
Catalog #	PKD-BW-N-835VHO-4
Lumens	4011
Watts	26.74
Efficacy	150

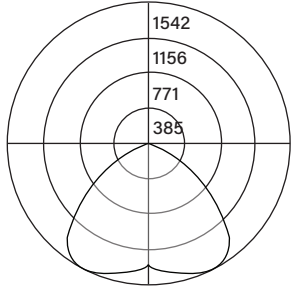

Indirect Batwing

Test #	KPL2015-176
Catalog #	PKI-N-BW-835VHO-4
Lumens	4008
Watts	30.7
Efficacy	130

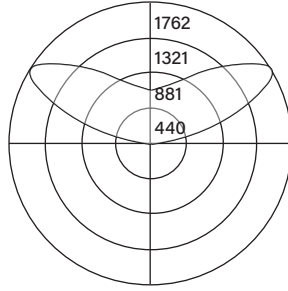

Direct/Indirect Batwing

Test #	KPL2015-192 & KPL2015-176
Catalog #	PKDI-BW-BW-835VHO-835VHO-4
Lumens	7995
Watts	57.4
Efficacy	139.3

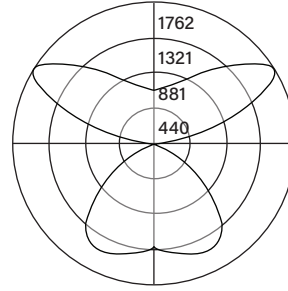

Candela Distribution

Vert Angle	Horizontal Angle				
	0	22.5	45	67.5	90
0	1363	1363	1363	1363	1363
5	1336	1354	1369	1381	1397
10	1314	1343	1382	1413	1438
15	1277	1324	1397	1456	1489
20	1226	1297	1411	1499	1532
25	1162	1262	1419	1520	1542
30	1085	1217	1408	1501	1513
35	997	1158	1364	1427	1436
40	901	1083	1279	1290	1284
45	799	990	1151	1090	1042
50	693	879	988	848	772
55	587	753	795	620	540
60	481	616	600	438	380
65	378	475	428	307	275
70	279	343	285	212	196
75	185	221	172	137	129
80	101	117	87	77	74
85	34	38	34	34	34
90	2	2	1	1	1

Candela Distribution

Vert Angle	Horizontal Angle				
	0	22.5	45	67.5	90
90	2	3	4	4	4
95	33	49	57	43	39
100	85	150	266	205	158
105	141	240	519	500	402
110	196	312	724	901	807
115	249	363	836	1284	1298
120	301	408	856	1491	1669
125	351	454	841	1488	1762
130	400	499	830	1383	1658
135	448	542	825	1260	1496
140	495	581	820	1151	1335
145	541	616	811	1057	1195
150	583	645	799	976	1074
155	620	669	783	905	972
160	653	688	765	844	887
165	680	702	749	792	817
170	699	711	736	754	766
175	711	717	727	730	735
180	720	720	720	720	720

Candela Distribution

Vert Angle	Horizontal Angle				
	0	22.5	45	67.5	90
0	1363	1363	1363	1363	1363
5	1336	1354	1369	1381	1397
10	1314	1343	1382	1413	1438
15	1277	1324	1397	1456	1489
20	1226	1297	1411	1499	1532
25	1162	1262	1419	1520	1542
30	1085	1217	1408	1501	1513
35	997	1158	1364	1427	1436
40	901	1083	1279	1290	1284
45	799	990	1151	1090	1042
50	693	879	988	848	772
55	587	753	795	620	540
60	481	616	600	438	380
65	378	475	428	307	275
70	279	343	285	212	196
75	185	221	172	137	129
80	101	117	87	77	74
85	34	38	34	34	34
90	2	2	1	1	1

Luminance Data (cd/sq.m)

Angle In Degrees	Average 0-Deg	Average 45-Deg	Average 90-Deg
45	37963	53915	49542
55	34394	46557	31613
65	30054	33687	21840
75	23960	22798	16803
85	13040	13279	13152

Luminance Data (cd/sq.m)

Angle In Degrees	Average 0-Deg	Average 45-Deg	Average 90-Deg
45	37963	54723	49542
55	34394	46554	31613
65	30054	34035	21840
75	23960	22329	16803
85	13040	13064	13152

For all available IES files, please visit our website at pinnacle-ltg.com. Photometry testing in accordance to IESNA-LM-79-08 at an NVLAP or IAS accredited testing laboratory. Testing conducted at 25°C ambient conditions

Specifications and dimensions subject to change without notice. Specification sheets that appear on pinnacle-ltg.com are the most recent version and supersede all other previously printed or electronic versions.

Designed in Denver, CO • USA | pinnacle-ltg.com | O: 303-322-5570 F: 303-322-5568

PK_ARM_SPEC_MAY2026



Applications & Certificates

Construction: Extruded aluminum housing with machined aluminum end caps and hubs. Highly reflective white reflector material optimizes luminaire efficiency.

Shielding: Lens options include frosted diffuse and nanostructured polycarbonate lenses for a range of optical distributions. Micro baffle features white or black injection-molded polycarbonate louvers with a frosted diffuse lens.

Mounting: Pendant Arm or Wall Arm. Refer to installation instructions for appropriate ceiling detail.

LED: 25°C test environment. Lumen output/wattage has a margin of +/- 5%; 2' or 3' lengths may have a greater wattage deviation. Luminaire configurations tested in accordance with IES LM-79. Diodes tested in accordance with IES LM-80. Lifetime calculated using IES TM-21. Minimum lifetime greater than 60,000 hours. Lifetime Projection L70 = 254,800 hours and L90 = 80,200 hours. MacAdam 3-Step Ellipses. For all available IES files, please visit our website at pinnacle-ltg.com.

CRI, CCT & Output: Not all lumen packages available. Three lumen packages available. Standard, High (HO) and Very High (VHO). Custom outputs are available. Specify custom lumens or watts between standard offering listed on CRI, CCT & Output page. 80 CRI is available for 3000K, 3500K, and 4000K. 90 CRI is available for 2700K, 3000K, 3500K and 4000K. 90 CRI = R9≥50.

Voltage: Universal (U), 120 volt (1), 277 volt (2) and 347 volt (3) options available. Must specify PL4 or OL4 in Driver section when 347 volt (3) is selected. Some configurations will not accommodate all voltage options; consult with factory.

Driver: Standard Driver option is Factory Selected Driver 0-10V, 1% = FSD. Electronic driver, Power factor is >0.9 with a THD <20%. Driver Lifetime: 50,000 hours at 25°C ambient operating conditions. For more driver options, see Pinnacle Resource Guide. Some configurations will not accommodate all driver options.

Remote Mounting Guide

Distance limited by max input watts shown.

	4w/ft	6w/ft	8w/ft	10w/ft
	16 AWG - 126ft	16 AWG - 79ft	16 AWG - 55ft	16 AWG - 41ft

Contact factory for other suspension lengths or wire gauge recommendations

Circuiting: Select from single circuit (1), dual circuit (2) or Emergency circuit (E). Some configurations will not accommodate all circuiting options; consult with factory.

Battery & Emergency: Select battery or emergency options if required. If battery or emergency option is not required, enter 0. Battery duration is 90 minutes as standard. Test button is remote to fixture. For more Battery options, see Pinnacle Resource Guide.

Finish: Standard powder-coat textured white, matte aluminum or textured black painted finish; consult factory for chip of standard paint finishes. Contact factory for additional custom color and finish options.

Controls: MOD options available, consult with factory.

Labels: UL and cUL 1598 listed. Approved for dry/damp location unless otherwise noted.

Fixture Weight: Maximum fixture weight is 2.7 lbs for a standard 4' fixture.

Warranty: PIKA offered with a 5-year limited warranty. Covers LED, driver and fixture.