

RENEW

2" Suspended Direct/Indirect Linear



Key Features

- Made with FSC® Certified solid oak wood material in 5 finishes
- Extruded aluminum core provides rigidity and enables precision joining and integral driver
- Up to 60% reduction in aluminum usage versus traditional extruded aluminum linear solutions
- Regressed lensing emphasizes wood grain
- Individual or continuous row in suspended mount



Example Part #: RNDI-A-BW-835HO-835HO-24'-AC48G1-U-FSD-1-0-NT-NT

RNDI	-	A												
	DIRECT SHIELDING	INDIRECT SHIELDING	DIRECT SOURCE	INDIRECT SOURCE	LENGTH	MOUNTING	VOLTAGE	DRIVER	CIRCUITING	BATTERY & EMERGENCY	WOOD FINISH	ACCENT FINISH	FIXTURE OPTIONS	

---	---	-----	-----
DIRECT SHIELDING	INDIRECT SHIELDING	DIRECT SOURCE ^{1, 2}	INDIRECT SOURCE ^{1, 2}
A - Satine Lens	HE - High Efficiency BW - Batwing WHE - Asymmetric <i>Shielding pg. 2</i>	927 - 90CRI, 2700K 30 - 80 or 90CRI, 3000K 35 - 80 or 90CRI, 3500K 40 - 80 or 90CRI, 4000K TW - Tunable White (90CRI, 2700-6500K) CL - Custom Lumens CW - Custom Watts <i>Direct Source pg. 2</i>	SO - 500 lm/ft HO - 750 lm/ft VHO - 1000 lm/ft 927 - 90CRI, 2700K 30 - 80 or 90CRI, 3000K 35 - 80 or 90CRI, 3500K 40 - 80 or 90CRI, 4000K TW - Tunable White (90CRI, 2700-6500K) CL - Custom Lumens CW - Custom Watts <i>Indirect Source pg. 3</i>

---	-----	-	---	-
LENGTH ³	MOUNTING ⁴	VOLTAGE ⁵	DRIVER	CIRCUITING ⁶
___ - Individual Fixture ___ - Continuous Row <i>Length pg. 3</i>	AC - AC to Grid AC - AC to J Box AC - AC to Structure AC5 - 5" Non-Power Canopy AC5 - 5" Non-Power Canopy SQ - 5" Square Canopy SQ - 5" Square Canopy <i>Mounting pg. 4</i>	U - Universal (120 thru 277V) 1 - 120V 2 - 277V 3 - 347V <i>Voltage pg. 4</i>	FSD - Factory Select Driver (1%, 0-10v) PL2 - Advance Xitanium (1%, 0-10v) OL2 - eldoLED Optotronic (1%, 0-10v) OL4 - eldoLED Optotronic 347V (1%, 0-10v) EE1 - eldoLED Ecodrive (1%, 0-10v) ES1 - eldoLED SOLOdrive (0.1%, 0-10v) LH1 - Lutron Hi-lume (1%, EcoSystem) PS1 - Advanced Xitanium (50%/100%) EH1 - ELV 120v Only <i>Driver pg. 4</i>	1 - Single Circuit 2 - Dual Circuit M - Multi Circuit E - Emergency (entire fixture) N - Night Light (entire fixture) <i>Circuiting pg. 5</i>

---	---	-----	---
BATTERY & EMERGENCY ⁷	WOOD FINISH	ACCENT FINISH (Endcaps & Joiners)	FIXTURE OPTIONS ⁸
0 - None FSB - Factory Select Battery FSG - Factory Select ALCR GI - Iota ETS DR GB - Bodine GTD ILL - Iota 10W PLL - Bodine 10W <i>Battery & Emergency pg. 5</i>	WH - White AS - Ash NT - Natural WN - Walnut BS - Black Sumi <i>Wood Finish pg. 5</i>	WH - White Accent AS - Ash Accent NT - Natural Accent WN - Walnut Accent BS - Black Sumi Accent <i>Accent Finish pg. 5</i>	DSP - Customer Supplied Battery/Driver/Sensor BA - Buy America(n) Act and/or Build America Buy America Compliant <i>Fixture Options pg. 5</i>

¹When specifying SOURCE the first _ is for specifying either **8** - 80CRI, **9** - 90CRI. The ending ___ are for specifying output, example 835HO - 80CRI, 3500K High Output. See output charts for more information. ²When specifying Tunable White, use **TW** and then specify output, example TWHO - Tunable White 90CRI, High Output 2700-6500K. See output charts for more information. Tunable White option requires driver option **FSD** which provides separate 0-10v control leads for Intensity and CCT. ³Individual fixtures come in 4', 5', 6', 7' & 8' lengths. Continuous rows come in 1' increments past 8'. Longer lead-time applies to 5' and 7' lengths. ⁴Specify AC Cable length standard AC is 48"; Specify grid: **G1**=15/16", **G9**=9/16", **GS**=Screw Slot. Example: AC48G1 ⁵Tunable White (**TW**) option only available with Universal (**U**), 120V (**1**) or 277V (**2**) options. ⁶Consult factory for Emergency (**E**) or Night Light (**N**) options with Tunable White (**TW**) option. ⁷Enter quantity for Battery and Emergency, Example 1FSB. ⁸Compliance is configuration dependent; consult factory for confirmation.

Specifications and dimensions subject to change without notice. Specification sheets that appear on pinnacle-ltg.com are the most recent version and supersede all other previously printed or electronic versions.



Shielding

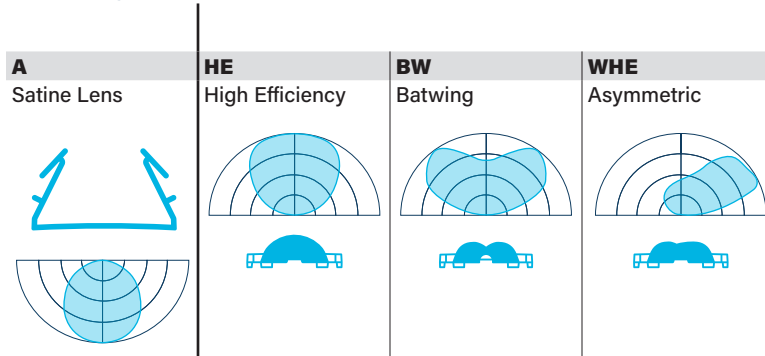

Direct Source

- Performance values shown for White (WH) finish. Use Light Loss Factor table provided for other finishes. Specify either 80 or 90 CRI for White light LED
- Specify either 80 or 90 CRI for White light LED
- Longer lead-time may apply for 90 CRI or Tunable White option. Consult factory
- Tunable White option requires driver option FSD which provides separate 0-10v control leads for Intensity and CCT.
- Tunable White lumen packages shown at 4000K CCT setpoint
- 90 CRI = R9≥50

Custom Output - Lumens OR Wattage

CL _____	Specify CRI, CCT and desired lumens (i.e. CL835500)	Specify lumens up to maximum output. Max. lumens approx. 1250 lms/ft. Lumens are specified per color temp
CW _____	Specify CRI, CCT and desired wattage (i.e. CW9407)	Specify watts between standard offering listed below
CLTW _____	Specify desired lumens for Tunable White (i.e. CLTW3200)	Specify lumens up to maximum output. Max. lumens approx. 900 lms/ft. Lumens are specified at 4000K CCT setpoint.

80 CRI

	Color	Lumens per foot	Shielding ¹	
			A Satine LPW	Watts/ft
830SO	3000K	500	110	4.6
830HO		750	112	6.7
830VHO		1000	113	8.9
835SO	3500K	500	113	4.4
835HO		750	113	6.6
835VHO		1000	116	8.6
840SO	4000K	500	113	4.4
840HO		750	113	6.6
840VHO		1000	116	8.6

90 CRI

927SO	2700K	500	91	5.5
927HO		750	92	8.1
927VHO		1000	92	10.9
930SO	3000K	500	99	5.0
930HO		750	99	7.6
930VHO		1000	100	10.0
935SO	3500K	500	99	5.1
935HO		750	98	7.6
935VHO		1000	100	10.0
940SO	4000K	500	99	5.1
940HO		750	98	7.6
940VHO		1000	100	10.0

2 CH Tunable White (2700-6500K, 90CRI)

TWSO	2700 - 6500K	500	93.3	5.4
TWHO		750	90.4	8.3
TWVHO		1000	N/A	

Wood Finish Light Loss Factors

FINISH	LUMEN MULTIPLIER
White (WH)	1.00
Ash (AS)	.99
Natural (NT)	.95
Walnut (WN)	.94
Black Sumi (BS)	.88

Specifications and dimensions subject to change without notice. Specification sheets that appear on pinnacle-ltg.com are the most recent version and supersede all other previously printed or electronic versions.



Indirect Source

- Specify either 80 or 90 CRI for White light LED
- Longer lead-time may apply for 90 CRI or Tunable White option. Consult factory
- Tunable White option requires driver option FSD which provides separate 0-10v control leads for Intensity and CCT.
- Tunable White lumen packages shown at 4000K CCT setpoint
- 90 CRI = R9≥50

Custom Output - Lumens OR Wattage

CL _____	Specify CRI, CCT and desired lumens (i.e. CL835500)	Specify lumens up to maximum output. Max. lumens approx. 1500 lms/ft. Lumens are specified per color temp
CW _____	Specify CRI, CCT and desired wattage (i.e. CW9407)	Specify watts between standard offering listed below
CLTW _____	Specify desired lumens for Tunable White (i.e. CLTW3200)	Specify lumens up to maximum output. Max. lumens approx. 900 lms/ft. Lumens are specified at 4000K CCT setpoint.

INDIRECT 80 CRI

	Color	Lumens per foot	Shielding ¹					
			HE High Efficiency		BW Batwing		WHE Asymmetric Lens	
			LPW	Watts/ft	LPW	Watts/ft	LPW	Watts/ft
830SO	3000K	500	140	3.6	131	3.8	107	4.7
830HO		750	146	5.1	136	5.5	109	6.9
830VHO		1000	147	6.8	137	7.3	109	9.1
835SO	3500K	500	145	3.4	135	3.7	110	4.5
835HO		750	151	5.0	141	5.3	110	6.8
835VHO		1000	148	6.8	141	7.1	113	8.8
840SO	4000K	500	145	3.4	135	3.7	110	4.5
840HO		750	151	5.0	141	5.3	110	6.8
840VHO		1000	148	6.8	141	7.1	113	8.8

INDIRECT 90 CRI

927SO	2700K	500	118	4.2	110	4.5	88	5.7
927HO		750	118	6.4	110	6.8	90	8.4
927VHO		1000	121	8.3	113	8.9	89	11.2
930SO	3000K	500	124	4.0	120	4.2	96	5.2
930HO		750	129	5.8	120	6.3	98	7.7
930VHO		1000	132	7.6	123	8.1	97	10.3
935SO	3500K	500	124	4.0	120	4.2	96	5.2
935HO		750	129	5.8	119	6.3	97	7.7
935VHO		1000	132	7.6	122	8.2	97	10.3
940SO	4000K	500	124	4.0	120	4.2	96	5.2
940HO		750	129	5.8	119	6.3	97	7.7
940VHO		1000	132	7.6	122	8.2	97	10.3

2 CH Tunable White (2700-6500K, 90CRI)

TWSO	2700 - 6500K	500	122.2	4.1	112.8	4.4	90.7	5.5
TWHO		750	121.4	6.2	112.4	6.7	87.8	8.5
TWVHO		1000	118.8	8.4	109.5	9.1	N/A	

Wood Finish Light Loss Factors

FINISH	LUMEN MULTIPLIER
White (WH)	1.00
Ash (AS)	1.00
Natural (NT)	.99
Walnut (WN)	.99
Black Sumi (BS)	.99

Length

- Units specified as individuals cannot be joined. Unit construction is specific to individuals, start/end of run, and middle of run
- Longer lead-times apply for 5' & 7' lengths. Consult factory
- Illuminated length is nominal, ends add 1-1/4" to each end

4	5*	6	7*	8	-
Indiv. Fixture	Indiv. Fixture	Indiv. Fixture	Indiv. Fixture	Indiv. Fixture	Cont. Run
50-1/2" (1282.7mm)					Specify nominal overall row length to the foot.
62-1/2" (1587.5mm)					
74-1/2" (1892.3mm)					
86-1/2" (2197.1mm)					
98-1/2" (2501.9mm)					

Specify to the foot >>>

Specifications and dimensions subject to change without notice. Specification sheets that appear on pinnacle-ltg.com are the most recent version and supersede all other previously printed or electronic versions.



Mounting

- Specify cable length in ordering code (AC48G1)
- Standard adjustable cable. Specify 48", 120", 240" or 350"
- End plates and power cord attached at factory
- Aircraft cable (AC) mounts on 4' (1219.2mm) and 8' (2438.4mm) centers
- AC Cable supplied with 5" (127mm) power and 2" (50.8mm) non-power canopies

AC_G1	Aircraft Cable 1" (15/16") T-Bar
AC_G9	Aircraft Cable 9/16" T-Bar
AC_GS	Aircraft Cable Screw Slot T-Bar
AC_JB	Aircraft Cable Junction Box
AC_ST	Aircraft Cable Structure
AC5_G	Aircraft Cable 5" (127mm) Non-Power Canopy
AC5_JB	Aircraft Cable 5" (127mm) Non-Power Canopy
SQ_G	Aircraft Cable 5" (127mm) Square Canopy
SQ_JB	Aircraft Cable 5" (127mm) Square Canopy

Tongue and Groove Joiner System

- Tongue-and-Groove Joiner comes standard for all runs
- Internal joiner cinches the housings together for a rigid connection
- Joiner adjusting bracket feature ensures straight continuous runs
- Tongue-and-Groove wood joiners eliminate light leaks
- No breaks in illumination - continuous line of light

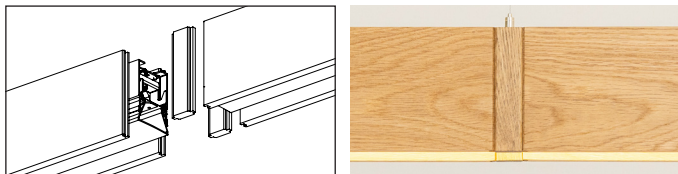

- Canopies and power cords are white or black based on fixture finish—black with Black Sumi, white with all other finishes, canopies are painted metal
- Approved for dry location unless otherwise noted
- Refer to installation instructions during installation at the job site
- Maximum fixture weight is 16 lbs for a standard 4' fixture

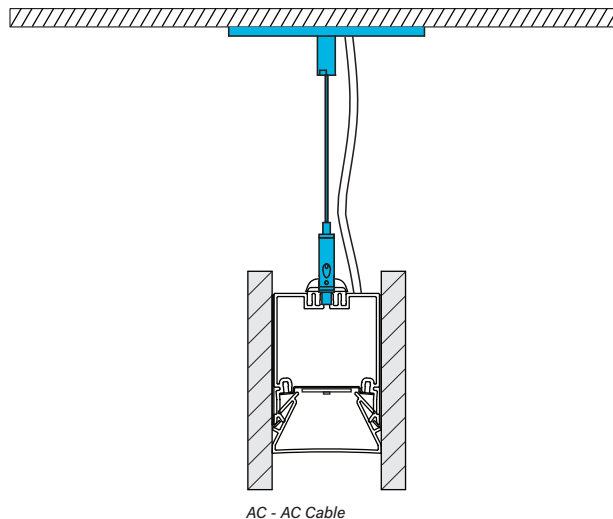

Voltage

- Some configurations will not accommodate all voltage options; consult with factory
- 347 volt not available with Tunable White (TW) option

U	Universal
1	120 volt
2	277 volt
3	347 volt

Driver

- Standard Driver Option = FSD 1%, 0-10V
- Driver Lifetime: 50,000 hours at 25°C ambient operating conditions

- For more driver options see Pinnacle Resource Guide
- Some configurations will not accommodate all driver options; consult with factory

0-10V Drivers

FSD	Factory Select Driver 1%, 0-10v
PL2	Advance Xitanium 1%, 0-10v
PL4	Advance Xitanium 347v 1%, 0-10v, requires 347v option
OL2	eldoLED Optotronic, 1%, 0-10v
OL4	eldoLED Optotronic 347v, 1% 0-10v, requires 347v option
EE1	eldoLED ECOdrive 1%, 0-10v, Logarithmic
EE2	eldoLED ECOdrive 1%, 0-10v, Linear
ES1	eldoLED SOLOdrive 0.1%, 0-10v, Logarithmic
ES2	eldoLED SOLOdrive 0.1%, 0-10v, Linear

DALI Drivers

EE3	eldoLED ECOdrive 1%, DALI 2, Logarithmic, DT6
ES3	eldoLED SOLOdrive 0.1%, DALI 2, Logarithmic, DT6

Lutron Drivers

LH1	Lutron Hi-lume Soft-on, Fade-to-Black 1%, EcoSystem, LDE1
------------	---

Alternate Drivers

PS1	Advance Xitanium Step Dimming 50%/100%
EH1	ERP 1%, Line Voltage and ELV, requires 120v

Specifications and dimensions subject to change without notice. Specification sheets that appear on pinnacle-ltg.com are the most recent version and supersede all other previously printed or electronic versions.

Designed in Denver, CO • USA | pinnacle-ltg.com | O: 303-322-5570

RNDI_LED_SPEC_SEPTEMBER2025



How to Specify Circuiting, Battery and Emergency

- 1**
- Select fixture circuiting from options below
 - Some configurations will not accommodate all circuiting options, consult with factory
 - Consult factory for Emergency (E) or Night Light (N) circuit with Tunable White (TW) option

Circuiting

1	Single Circuit
2	Dual Circuit (Independent up/down)
M	Multi Circuit
E	Emergency Circuit only
N	Night Light Circuit only

- 2** + **3**
- Battery and emergency section options are available in addition to fixture circuit
 - Select battery and emergency section options below; factory shop drawing required
 - Some configurations will not accommodate all circuiting options, consult with factory

Battery and/or Emergency If Required

- 0** No battery or specific emergency section required

Battery

- Select battery section type if required, indicate total QTY. *Example 2PLL*
- 90 minute battery runtime; test button location dependent on configuration, consult factory
- No battery option available for 2' lengths
- Entire direct fixture housing is on battery for lengths up to 5'
- Half of direct fixture is on battery for 6' or 8' housing lengths

0	No Battery
_FSB	Factory Select Battery (10w option)
_FSBST	Factory Select Battery (10w, Self Testing)
_PLL	Bodine 10w Integral Lithium, Self Testing
_ILL	Iota 10w Integral Lithium, Self Testing

- For more battery options available, see Pinnacle Resource Guide
- For Tunable White (TW) option, battery will illuminate 6500K LED during emergency operation unless otherwise specified

For Approximate Battery Lumen Output

- Multiply battery wattage X fixture LPW shown on Lumen Table
- 10 (watts) x 113 (LPW) = 1130 battery lumen output

Emergency

- Select emergency section type if required, indicate total QTY. *Example 1E*
- Combine battery and emergency section ordering codes if both options are selected

_FSG	Factory Select ALCR Emergency Control Device, UNV
_GI	Iota ETS-DR, Emergency Control Device, UNV
_GB	Bodine GTD, Emergency Control Device, 120v or 277v
_E	Emergency circuit section
_N	Night Light circuit section

- Consult factory for Emergency Control Devices with Tunable White (TW) option

Battery OR Emergency Ordering Examples

- | | |
|--|-----------------------|
| • Single circuit, 10w Integral Battery | Ordering Code: 1-1FSB |
| • Emergency only, 10w Integral Battery | Ordering Code: E-1PLL |
| • Single circuit, GTD required | Ordering Code: 1-1GB |



Wood Finish

- FSC® Certified solid white oak from responsibly managed U.S. forests, sourced in partnership with Anthology Woods.
- Wood material is Declare Red List Approved
- Five different wood finishes
- Accent finish applies to endcaps and joiner(s) for wood finish combinations. If no accent is desired, select the same wood finish for both finish selections.
- Each piece of wood tells its own story—subtle shifts in color, grain, and texture make every luminaire unique. Selected for consistency and quality, our wood elements embrace the natural beauty that makes each piece stunning

WH - White

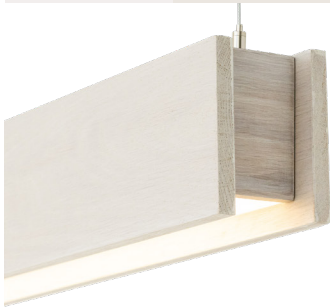

AS - Ash

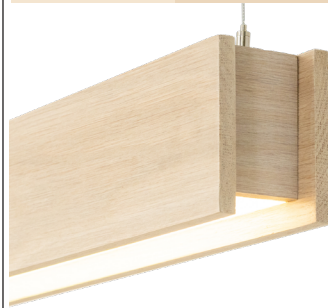

NT - Natural



WN - Walnut



BS - Black Sumi



Accent Finish (Optional)

- Shown is Natural (NT) finish with White (WH) accent finish

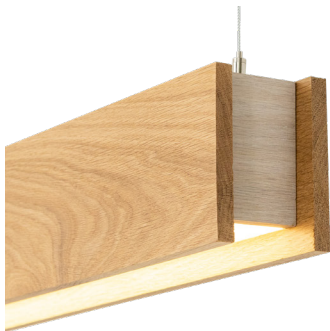

Fixture Options

- Additional options to enhance the fixture and finish of the product

DSP Customer Supplied Battery/Driver/Sensor

- Domestic content option - compliance is configuration dependent; consult factory for conformation

BA Buy America(n) Act and/or Build America Buy America Compliant



Photometrics

Satine Lens

Test # SCALED FROM KPL2015-114 & KPL2015-122
 Catalog # RNDI-A-WHE-840VHO-840VHO
 Lumens 8405 lms
 Watts 61.1 W
 Efficacy 138 LPW

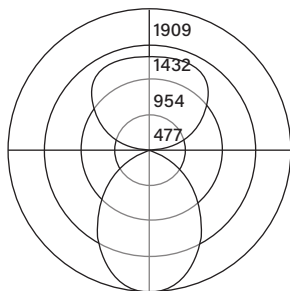

Candela Distribution

Vert Angle	Horizontal Angle				
	0	22.5	45	67.5	90
0	1903	1903	1903	1903	1903
5	1877	1884	1893	1892	1891
10	1846	1848	1845	1834	1828
15	1798	1792	1769	1745	1734
25	1642	1611	1554	1504	1478
35	1432	1376	1283	1202	1165
45	1182	1105	979	876	831
55	911	814	666	556	512
65	621	513	363	276	246
75	324	228	120	99	97
85	77	42	33	30	29
90	4	6	3	2	3
95	72	148	89	45	35
105	270	348	413	401	385
115	473	531	603	640	656
125	659	711	787	838	858
135	820	881	975	1028	1051
145	970	1024	1122	1187	1214
155	1102	1136	1200	1247	1267
165	1196	1212	1243	1263	1269
175	1247	1250	1262	1264	1262
180	1258	1258	1258	1258	1258

Luminance Data (cd/sq.m)

Angle In Degrees	Average 0-Deg	Average 45-Deg	Average 90-Deg
45	24054	19918	16900
55	22843	16705	12843
65	21142	12350	8360
75	17989	6685	5377
85	12658	5440	4748

For all available IES files, please visit our website at pinnacle-ltg.com. Photometry testing in accordance to IESNA-LM-79-08 at an NVLAP or IAS accredited testing laboratory. Testing conducted at 25°C ambient conditions

Applications & Certificates

Construction: FSC® Certified solid white oak from responsibly managed U.S. forests, sourced in partnership with Anthology Woods. 6063-T6 extruded aluminum inner core houses integral driver and supports precision joinery. High-reflectance white painted steel reflector.

Shielding: Direct: Regressed diffuse snap-in acrylic lens for enhanced visual cutoff; removable for maintenance. Indirect: over optic with Lambertian, batwing, or asymmetric distributions; covers LED boards and supports wipe-down maintenance. Optional dust cover available upon request.

Mounting: Aircraft cable and surface mount available. Aircraft cable mounts are individual unit is nominal length -.75" (8' fixture is 95.25"). BOR/EOR is nominal length -.375 (8' fixture is 95.625"). MOR is nominal length (8' fixture is 96"). Aircraft Cable supplied with 5" (127mm) power and 2" (50.8mm) non-power canopies. Refer to installation instructions for appropriate ceiling detail.

White LED: 25°C test environment. Lumen output/wattage has a margin of +/- 5%. Luminaire configurations tested in accordance with IES LM-79. Diodes tested in accordance with IES LM-80. Lifetime calculated using IES TM-21. Minimum lifetime greater than 60,000 hours. TM-21-21 Lifetime Rating L70 = >54,000 hours, L90 = >54,000 hours. Mac-Adam 3-Step Ellipses. For all available IES files, please visit our website at pinnacle-ltg.com.

Tunable White LED: 2 channel 0-10v solution with 2700K-6500K tunable range, 90 CRI, R9>50. Lumen packages available shown at 4000K CCT setpoint, lumen output varies based on CCT. Use multipliers for other CCT; 2700K = .91 3000K = .93 3500K = .97 4000K = 1.0 5000K = 1.044 6500K = 1.078.

CRI, CCT & Output: Not all lumen packages available. Three lumen packages available: SO (Standard), High (HO), Very High (VHO). Custom outputs are available. Specify custom lumens or watts between standard offering listed on CRI, CCT & Output page. 80 CRI is available for 3000K, 3500K, and 4000K. 90 CRI is available for 2700K, 3000K, 3500K and 4000K. 90 CRI = R9≥50.

Voltage: Universal (U), 120 volt (1), 277 volt (2) and 347 volt (3) options available. Must specify PL4 or OL4 in Driver section when 347 volt (3) is selected. Some configurations will not accommodate all voltage options; consult with factory.

Driver: Standard Driver Option is Factory Select Driver 0-10V, 1% = FSD. Electronic driver, Power factor is >0.9 with a THD <20%. Driver Lifetime: 50,000 hours at 25°C ambient operating conditions. Ambient operating range: -20°F/-30°C to 107°F/41°C. For more driver options, see Pinnacle Resource Guide. Some configurations will not accommodate all driver options.

Circuiting: Select from single circuit (1), Multi circuit - For multiple circuiting and zone control, requires factory shop drawing (M), Emergency circuit (E) or Night Light circuit (N). For emergency circuiting situations that require no through wire or circuit separation, Life Safety Circuit should be selected. This will provide a separate power feed and only the Life Safety Circuit in that section. Some configurations will not accommodate all circuiting options; consult with factory.

Battery & Emergency: Select battery or emergency options if required. If battery or emergency option is not required, enter 0. Battery duration is 90 minutes as standard. Test button location dependent on configuration, consult factory. For more battery options, see Pinnacle Resource Guide.

Wood Finish: Available in five standard finishes, each coated with a low VOC polyurethane for an eco-conscious, durable finish. Custom finishes available - consult factory.

Controls: Mod options available, consult with factory.

Buy America Act (BAA) and Build America, Buy America Act (BABA) Compliance: BAA and/or BABA compliance options are available to support federally funded projects requiring domestic content. Availability depends on configuration; Compliance is configuration-dependent; consult factory for confirmation.

Labels: UL and cUL 2108 or 1598 listed depending on product configuration. Approved for dry location unless otherwise noted. Wood material is Declare Red List Approved and Greenguard Gold Certified.

Fixture Weight: Maximum fixture weight is 16lbs per 4' fixture.

Warranty: 5-year limited warranty.

Specifications and dimensions subject to change without notice. Specification sheets that appear on pinnacle-ltg.com are the most recent version and supersede all other previously printed or electronic versions.