

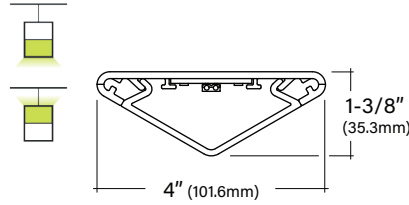

FACTORY DRAWING AND SIGN OFF REQUIRED WITH THIS PRODUCT.



VERBENA V4AJ

4" Direct and Indirect Linear with Alternating Joint



Indirect Orientation

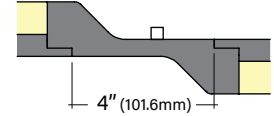

Specification Features

- Triangular lens form factor with 145LPW direct or 165LPW indirect widespread illumination
- Enhanced lighting pattern with 6% contribution past nadir
- Minimalistic profile with overall height less than 1 1/2" with triangular lens
- Integral suspension and power cable with singular adjustment mechanism
- Triangular lens form factor with up to 2000lm/ft or 2300lm/ft indirect widespread illumination
- Milled X, T, Y, 90°, 120°, 135° connectors, and a direct-to-indirect alternating joint



Example Part #: V4AJ-A-830HO-26'-CAC48JB-U-FSD-1-0-W

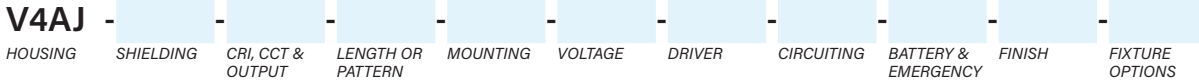

V4AJ			
HOUSING	SHIELDING	CRI, CCT & OUTPUT ¹	LENGTH OR PATTERN ²
V4AJ - Verbena 4 Alternating Joint <i>Housing pg. 2</i> For straight runs, specify overall nominal length. Use page 7 to draw out the straight run and include all alternating joints while indicating light directionality and shielding.	A - Satine Lens WS - Widespread Lens <i>Shielding pg. 2</i>	_ 27 _ - 2700K _ 30 _ - 3000K _ 35 _ - 3500K _ 40 _ - 4000K CL - Custom Lumens CW - Custom Watts <i>Lumen Output pg. 2</i>	__ - Individual Fixture _ - Continuous Row S - Square H - Hexagon O - Octagon R_x - Rectangle L_x - L-Shape U_x_x - U-Shape Y_x_x - Y-Shape T_x_x - T-Shape X_x_x_x - X-Shape <i>Length and Pattern pg. 2-3</i>
MOUNTING ³	VOLTAGE	REMOTE DRIVER	CIRCUITING
CAC__G - Conductive AC to Grid CAC__JB - Conductive AC to J Box <i>Mounting pg. 3</i>	U - Universal (120 thru 277V) 1 - 120V 2 - 277V 3 - 347V <i>Voltage pg. 4</i>	FSD - Factory Select Driver (1%, 0-10v) PL2 - Advance Xitanium (1%, 0-10v) OL2 - eldoLED Optotronic (1%, 0-10v) OL4 - eldoLED Optotronic 347V (1%, 0-10v) EE1 - eldoLED ECOdrive (1%, 0-10v) ES1 - eldoLED SOLOdrive (0.1%, 0-10v) LH1 - Lutron Hi-lume (1%, EcoSystem) <i>Driver pg. 4</i>	1 - Single Circuit E - Emergency (entire fixture) N - Night Light (entire fixture) <i>Circuiting pg. 4</i>
BATTERY & EMERGENCY ⁴	FINISH	FIXTURE OPTIONS ⁵	CONTROLS
0 - None _FSB - Factory Select Battery _FSG - Factory Select ALCR _GI - Iota ETS DR _ILL - Iota 10W _PLL - Bodine 10W _E - Emergency Section _N - Night Light Section <i>Battery and Emergency pg. 5</i>	W - White S - Metallic Silver BL - Textured Black BR - Bronze GR - Graphite CC - Custom Color <i>Finish pg. 5</i>	BA - Buy America(n) Act and/or Build America Buy America Compliant <i>Fixture Options pg. 5</i>	Pinnacle is able to accommodate different control solutions from different manufacturers. Consult Factory for more information.

¹When specifying CRI, CCT & OUTPUT the first _ is for specifying either **8** - 80CRI or **9** - 90CRI. The ending __ are for specifying output, example **HO** - High Output. See output charts for more information. ²Continuous row comes in 1' increments starting at 2'. For straight runs specify overall nominal length and use last page to draw out how the length should be broken down into directions. For patterns specified length will be fixture length. Patterns will be longer than specified length. For Mod layouts consult factory. ³Specify CAC length standard CAC is 48". Specify grid: G1=15/16", G9=9/16", GS=Screw Slot. Example: CAC48G1 ⁴Enter quantity for Battery and Emergency, Example 1PLL. ⁵Compliance is configuration dependent; consult factory for confirmation.

Specifications and dimensions subject to change without notice. Specification sheets that appear on pinnacle-ltg.com are the most recent version and supersede all other previously printed or electronic versions.



Shielding

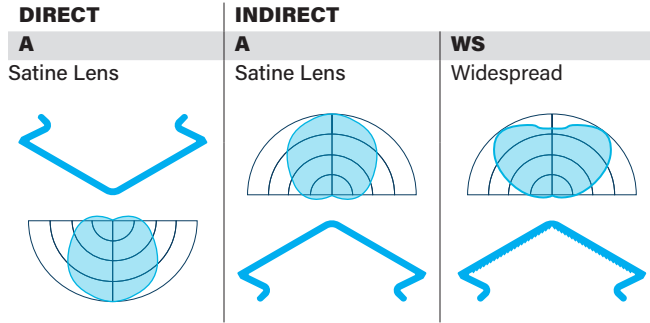

Output

- Specify either 80 or 90 CRI
- Longer lead-time may apply for 90 CRI. Consult factory.
- 90 CRI = R9≥50

Custom Output - Lumens OR Wattage

CL _____	Specify CRI, CCT and desired lumens (i.e. CL835500)	Total Max lumens: A Lens- 2,012, WS Lens- 2,330. Max lumens dependant on color temp. Consult factory for more information
CW _____	Specify CRI, CCT and desired wattage (i.e. CW9407)	Total Max watts: 14.8. Consult factory for more information

80 CRI

	Color	Output	Lumens per foot	Shielding			
				A Satine Lens		WS Widespread	
				LPW	Watts/ft	LPW	Watts/ft
830LO	3000K	Low	500	142	3.5	162	3.1
830MO	3000K	Medium	750	141	5.3	161	4.7
830HO	3000K	High	1000	141	7.1	159	6.3
835LO	3500K	Low	500	146	3.4	166	3.0
835MO	3500K	Medium	750	145	5.2	165	4.5
835HO	3500K	High	1000	145	6.9	164	6.1
840LO	4000K	Low	500	148	3.4	168	3.0
840MO	4000K	Medium	750	147	5.1	168	4.5
840HO	4000K	High	1000	146	6.9	167	6.0

90 CRI

927LO	2700K	Low	500	114	4.4	132	3.8
927MO	2700K	Medium	750	112	6.7	131	5.7
927HO	2700K	High	1000	111	9.0	131	7.7
930LO	3000K	Low	500	117	4.3	137	3.7
930MO	3000K	Medium	750	116	6.5	135	5.5
930HO	3000K	High	1000	115	8.7	135	7.4
935LO	3500K	Low	500	119	4.2	139	3.6
935MO	3500K	Medium	750	118	6.4	137	5.5
935HO	3500K	High	1000	117	8.5	137	7.3
940LO	4000K	Low	500	123	4.1	143	3.5
940MO	4000K	Medium	750	121	6.2	141	5.3
940HO	4000K	High	1000	120	8.3	141	7.1

Length

- All individual units cannot be joined, end plates are factory installed and cannot be removed
- End caps add 2-1/2" (1-1/4" per end) to the overall length of the fixture/row, end caps do not add to the mounting distance
- For patterns, refer to Pattern section on next page

2	3	4	5	6	7	8	-
Indiv. Fixture	Indiv. Fixture	Indiv. Fixture	Indiv. Fixture	Indiv. Fixture	Indiv. Fixture	Indiv. Fixture	Cont. Run Specify nominal overall row length to the 1'
24" (609.6mm)							
	36" (914.4mm)						
		48" (1219.2mm)					
			60" (1524mm)				
				72" (1828.8mm)			
					84" (2133.6mm)		
						96" (2438.4mm)	

Specify to the 1'

Specifications and dimensions subject to change without notice. Specification sheets that appear on pinnacle-ltg.com are the most recent version and supersede all other previously printed or electronic versions.

Designed in Denver, CO • USA | pinnacle-ltg.com | O: 303-322-5570 F: 303-322-5568

V4AJ_LED_SPEC_SEPTEMBER2025



Patterns

- If using alternating joint with patterns use last page to draw out the pattern
- Direction of light must be the same on all sides of a connector, can only change direction of light in straight section
- Specify pattern shape and requested fixture length
- Length specified will not reflect overall pattern dimensions
- Some connectors require longer lead-times. Angles and Shapes not shown

- require Mod Pattern; Consult Factory.
- All connectors are NON ILLUMINATED
- Driver/Battery Count dictated by product configuration
- Minimum length for any single part of a pattern is 2'
- All lengths are TO THE FOOT ONLY

S_	H_	O_	R_x_	U_x_x_	L_x_	Y_x_x_	T_x_x_	X_x_x_x_	MOD
Square Provide A dimension Example: S12'	Hexagon Provide A dimension Example: H12'	Octagon Provide A dimension Example: O12'	Rectangle Provide Ax B dimensions Example: R16'x12'	U-Shape Provide Ax BxC dimensions Example: U12'x16'x12'	L-Shape Provide Ax B dimensions Example: L12'x12'	Y-Shape Provide Ax BxC dimensions Example: Y12'x16'x12'	T-Shape Provide Ax BxC dimensions Example: T12'x12'x12'	X-Shape Provide Ax BxCxD dimensions Example: X12'x16'x12'x16'	MOD Multi Connector Layout For patterns other than shown, factory drawing and sign off required with all MODS

Non-illuminated Connector Details

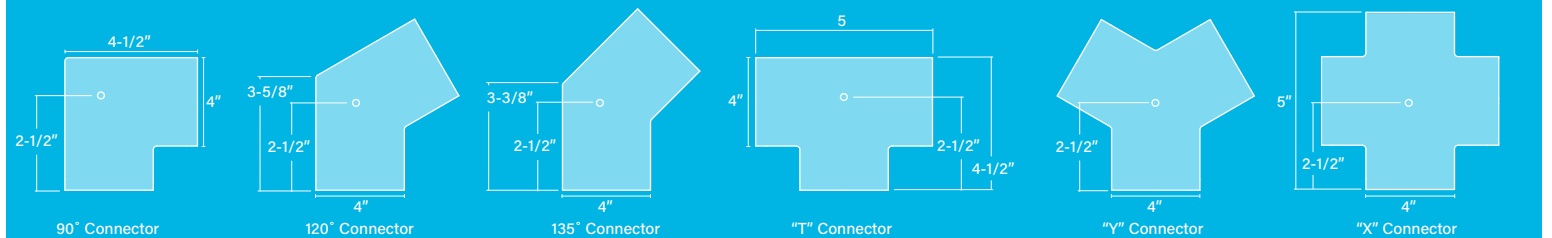

Mounting

- Driver/Battery Count dictated by product configuration
- Specify cable length in ordering code (CAC48JB)
- Standard adjustable cable. Specify 48", 120", 240", or 350"
- End plates attached at factory
- Canopies and mounts match fixture finish. See Finish section for additional

- details.
- Approved for dry/damp location unless otherwise noted
- Refer to installation instructions during installation at the job site
- Maximum fixture weight is 10 lbs for a standard 4' fixture

CAC__G_ Conductive AC to Grid (specify grid type: G1, G9, GS)
CAC__JB Conductive AC to Junction Box

CAC Canopy Details

- CAC is an integrated power and suspension cable that is smaller in diameter than a traditional SJT cable. CAC is 2 conductive cables and suspension, standard power cable (SJT) is 5 conductive cables and no suspension.

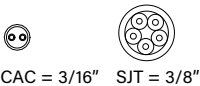

- A larger power side canopy allows for adjustability of the CAC cable inside of the canopy.

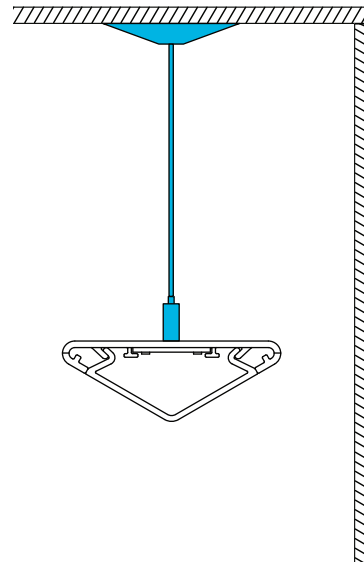
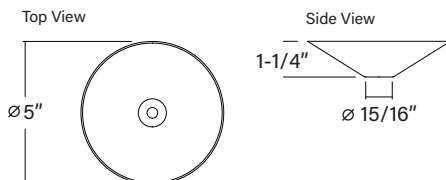

Specifications and dimensions subject to change without notice. Specification sheets that appear on pinnacle-ltg.com are the most recent version and supersede all other previously printed or electronic versions.



Voltage

- Some VERBENA configurations will not accommodate all voltage options; consult with factory

U	Universal
1	120 volt
2	277 volt
3	347 volt

Remote Driver

- Driver/Battery Count dictated by product configuration
- Standard Driver Option = FSD
- Driver Lifetime: 50,000 hours at 25°C ambient operating conditions
- For more driver options, see Pinnacle Resource Guide
- Some VERBENA configurations will not accommodate all driver options; consult with factory
- All configurations with no PLL, ILL or Emergency Control Device options will use Slim Remote Box

Slim Remote Box

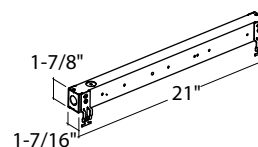

0-10V Drivers

FSD	Factory Select Driver (1%, 0-10v)
PL2	Signify Advance Xitanium 1%, 0-10v
PL4	Advance Xitanium 347v 1%, 0-10v, requires 347v
OL2	eldoLED Optotronic, 1%, 0-10v
OL4	eldoLED Optotronic 347v, 1% 0-10v, requires 347v option
EE1	eldoLED ECOdrive 1%, 0-10v Logarithmic
EE2	eldoLED ECOdrive 1%, 0-10v Linear
ES1	eldoLED SOLOdrive 0-10v, 0.1% Logarithmic
ES2	eldoLED SOLOdrive 0-10v, 0% Linear

DALI Drivers

EE3	eldoLED ECOdrive 1%, DALI 2, Logarithmic, DT6
ES3	eldoLED SOLOdrive 0.1%, DALI 2, Logarithmic, DT6

Lutron Drivers

LH1	Lutron Hi-lume Soft-on, Fade-to-black 1%, EcoSystem, LDE1
------------	---

How to specify Circuiting, Battery and Emergency

- Select fixture circuiting from options below
 - Some VERBENA configurations will not accommodate all circuiting options, consult with factory

Circuiting

1	Single Circuit
2	Dual Circuit
E	Emergency Circuit only
N	Night Light Circuit only

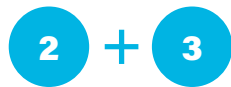

- Battery and emergency options are available in addition to fixture circuit
- Select battery and emergency options below; factory shop drawing required
- Some VERBENA configurations will not accommodate all circuiting options, consult with factory
- Configurations with PLL or ILL or any Emergency control device will require standard remote box.

Battery and/or Emergency *If Required*

0 No battery or specific emergency required

Battery

- Battery is REMOTE
- Select battery type if required, indicate total QTY. *Example 2PLL*
- 90 minute battery runtime; test button is remote to fixture
- Battery operates full length of housing up to 8' on individual fixtures or within continuous row
- For more battery options available, see Pinnacle Resource Guide

0	No battery
_FSB	Factory Select Battery 10w, Integral Lithium
_FSBST	Factory Select Battery 10w, Integral Lithium Self Testing
_ILL	Iota 10w, Integral Lithium, Self Testing
_IRC	Iota 10w, Remote, Dual conduit flex
_PLL	Bodine 10w, Integral Lithium, Self Testing
_PRD	Bodine 10w, Remote, Dual conduit flex

Standard Remote Box

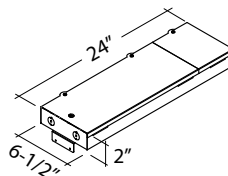

For Approximate Battery Lumen Output

- Multiply battery wattage X fixture LPW shown on Lumen Table
- 92.3 (LPW) x 10 (watts) = 923 battery lumen output

Emergency

- Emergency Control Device REMOTE in driver box
- Select emergency section type if required, indicate total QTY. *Example 1E*
- Combine battery and emergency section ordering codes if both options are selected
- Emergency circuiting sections are for use when specifying emergency options on continuous runs

_FSG	Factory Select ALCR Emergency Control Device, UNV
_GI	Iota ETS-DR, Emergency Control Device, UNV
_E	Emergency circuit
_N	Night Light circuit
_L	Life Safety circuit section NO THROUGH WIRE

Battery OR Emergency Ordering Examples

- Single circuit, 10w Integral Battery Ordering Code: 1-1PLL
- Emergency only, 10w Integral Battery Ordering Code: E-1PLL

Finish

- Standard powder-coat textured white, metallic silver, textured black, graphite or bronze painted finish; consult factory for chip of standard paint finishes
- Selecting a fixture finish other than white may impact lumen output; consult factory for more information

W	White (<i>white cord/white canopy</i>)
S	Metallic Silver (<i>white cord/silver canopy</i>)
BL	Textured Black (<i>black cord/black canopy</i>)
BR	Bronze (<i>white cord/bronze canopy</i>)
GR	Graphite (<i>white cord/graphite canopy</i>)
CC	Custom Color (<i>white cord/color match canopy</i>)

Fixture Options

- Domestic content option - compliance is configuration dependent; consult factory for conformation

BA Buy America(n) Act and/or Build America Buy America Compliant

Controls

- Pinnacle is able to accommodate different control solutions from different manufacturers. Consult Factory for more information.

Specifications and dimensions subject to change without notice. Specification sheets that appear on pinnacle-ltg.com are the most recent version and supersede all other previously printed or electronic versions.



Photometrics

Satine Lens

Test # KPL2015-4
 Catalog # V4D-A-N-40-4
 Lumens 3854 Lm
 Watts 27.9 W
 Efficacy 138 LPW

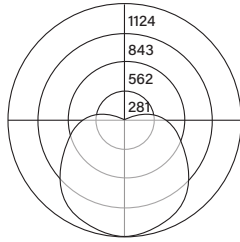

Widespread Lens

Test # KPL2015-3
 Catalog # V4I-N-WS-40-4
 Lumens 3856 Lm
 Watts 23.9 W
 Efficacy 161 LPW

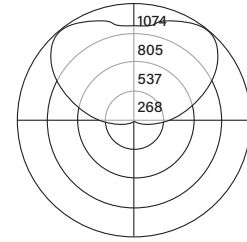

Candela Distribution

Vert Angle	Horizontal Angle				
	0	22.5	45	67.5	90
0	1115	1115	1115	1115	1115
5	1108	1111	1110	1107	1108
10	1093	1095	1096	1094	1095
15	1069	1072	1073	1072	1073
20	1035	1038	1041	1042	1042
25	992	995	1000	1002	1003
30	941	945	953	956	957
35	883	886	895	901	902
40	817	820	831	842	843
45	743	747	763	775	777
50	666	671	689	705	708
55	581	589	613	634	638
60	492	503	535	565	570
65	402	410	459	521	527
70	307	336	408	478	485
75	216	254	362	433	440
80	133	196	313	386	393
85	68	148	264	335	342
90	14	104	213	283	290

Luminance Data (cd/sq.m)

Angle In Degrees	Average 0-Deg	Average 45-Deg	Average 90-Deg
45	10392	8331	7968
55	9896	7475	7150
65	9110	6532	6835
75	7674	6250	6921
85	5963	6279	7174

Candela Distribution

Vert Angle	Horizontal Angle				
	0	22.5	45	67.5	90
90	12	88	198	242	244
95	40	131	265	313	316
100	87	184	338	389	390
105	145	242	412	473	475
110	212	311	490	560	568
115	285	387	573	646	650
120	358	461	662	731	737
125	428	536	746	824	830
130	500	607	818	911	917
135	573	674	877	981	990
140	641	732	918	1029	1040
145	703	782	942	1051	1062
150	759	825	956	1048	1059
155	811	861	961	1033	1041
160	855	890	960	1011	1017
165	889	910	954	984	989
170	914	924	945	959	962
175	930	934	938	940	942
180	936	936	936	936	936

For all available IES files, please visit our website at pinnacle-ltg.com. Photometry testing in accordance to IESNA-LM-79-08 at an NVLAP or IAS accredited testing laboratory. Testing conducted at 25°C ambient conditions



Applications & Certificates

Construction: 6063-T6 Extruded aluminum housing. Highly reflective die-formed white painted reflector.

Shielding: Diffuse snap-in acrylic lens with matte finish, removable for maintenance.

Mounting: Conductive Aircraft cable, wall and surface mount available. Power mount supplied with conductive aircraft cable and oval 6-1/2" H x 4-1/4" W canopy. Non-power supplied with aircraft cable and 2" (50.8mm) canopy. Refer to installation instructions for appropriate ceiling detail.

LED: 25°C test environment. Lumen output/wattage has a margin of +/- 5%; 2' or 3' lengths may have a greater wattage deviation. Luminaire configurations tested in accordance with IES LM-79. Diodes tested in accordance with IES LM-80. Lifetime calculated using IES TM-21. Minimum lifetime greater than 60,000 hours. L70 = 124,900 hours and L90 = 37,200 hours. MacAdam 3-Step Ellipses. Not all products are Lighting Facts listed. For all available IES files, please visit our website at pinnacle-ltg.com.

CRI, CCT & Output: Three lumen packages available. Low (LO), Medium (MO) and High (HO). Custom outputs are available. Specify custom lumens or watts between standard offering listed on CRI, CCT & Output page. 80 CRI is available for 3000K, 3500K, and 4000K. 90 CRI is available for 2700K, 3000K, 3500K, and 4000K. 90 CRI = R9≥50.

Voltage: Universal (U), 120 volt (1), 277 volt (2) and 347 volt (3) options available. Must specify OL4 in Driver section when 347 volt (3) is selected. Some VERBENA configurations will not accommodate all voltage options; consult with factory.

Driver: Standard Driver option is Factory Selected Driver 0-10V, 1% = FSD. Electronic driver, Power factor is >0.9 with a THD <20%. Driver Lifetime: 50,000 hours at 25°C ambient operating conditions. Ambient operating range: -20°F/-30°C to 107°F/42°C. For more driver options, see Pinnacle Resource Guide. Some VERBENA configurations will not accommodate all driver options.

Circuiting: Select from single circuit (1), Emergency circuit (E) or Night Light circuit (N). For emergency circuiting situations that require no through wire or circuit separation, Life Safety Circuit should be selected. This will provide a separate power feed and only the Life Safety Circuit in that section. Some VERBENA configurations will not accommodate all circuiting options; consult with factory.

Remote Mounting Guide

Distance limited by max input watts shown.

Max Distance	56' (.53A)	42' (.7A)	28' (1.05A)	20' (1.5A)	12' (2A)
4' Housing	4.0w/ft	5.4w/ft	8.1w/ft	11.6w/ft	17.2w/ft
8' Housing	N/A	2.6w/ft	4.0w/ft	5.8w/ft	7.8w/ft

Battery & Emergency: Select battery or emergency options if required. If battery or emergency option is not required, enter 0. Battery duration is 90 minutes as standard. Test button is remote to fixture. For more Battery options, see Pinnacle Resource Guide.

Finish: Standard powder-coat textured white, metallic silver, textured black, graphite or bronze painted finish; consult factory for chip of standard paint finishes. Contact factory for additional custom color and finish options.

Controls: Consult factory.

Buy America Act (BAA) and Build America, Buy America Act (BABA) Compliance: BAA and/or BABA compliance options are available to support federally funded projects requiring domestic content. Availability depends on configuration; Compliance is configuration-dependent; consult factory for confirmation.

Labels: UL and cUL 2108 Listed. Low, Medium and HO lumen packages are approved for dry/damp location unless otherwise noted.

Fixture Weight: Maximum fixture weight is 10 lbs for a standard 4' fixture.

Warranty: VERBENA offered with a 5-year limited warranty. Covers LED, driver and fixture.