

SORREL S3U

3" Suspended Direct/Indirect Linear

Specification Features

- Triangular rail shape creates a unique aesthetic while providing functional output.
- Integral suspension and power cable with singular adjustment mechanism.
- Standard connectors allow the fixtures to move effortlessly throughout the space.
- Indirect fixture distribution is 20% direct /80% indirect.



Example Part #: S3U-830HO-26'-CAC48JB-U-FSD-1-0-W

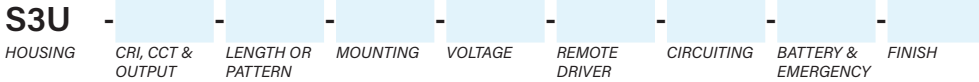

CRI, CCT & OUTPUT ¹	LENGTH OR PATTERN ²	MOUNTING ³	VOLTAGE
27 - 2700K _30_ - 3000K _35_ - 3500K _40_ - 4000K CL_____ - Custom Lumens CW_____ - Custom Watts <i>Lumen Output pg. 2</i>	__ - Individual Fixture (2', 3', 4', 5', 6', 7' & 8') __ - Continuous Row S_ - Square R_x_ - Rectangle L_x_ - L-Shape U_x_x_ - U-Shape Y_x_x_ - Y-Shape X_x_x_x_ - X-Shape <i>Length and Pattern pg. 2-3</i>	CAC__G_ - Conductive AC to Grid CAC__JB - Conductive AC to J Box <i>Mounting pg. 3</i>	U - Universal (120 thru 277V) 1 - 120V 2 - 277V 3 - 347V <i>Voltage pg. 4</i>

REMOTE DRIVER	CIRCUITING	BATTERY & EMERGENCY ⁴	FINISH
FSD - Factory Select Driver (1%, 0-10v) PL2 - Advance Xitanium (1%, 0-10v) PL4 - Advance Xitanium (1%, 0-10v, 347v) OL2 - eldoLED Optotronic (1%, 0-10v) EE1 - eldoLED ECOdrive (1%, 0-10v) ES1 - eldoLED SOLOdrive (0%, 0-10v) LH1 - Lutron Hi-lume (1%, EcoSystem) <i>Driver pg. 4</i>	1 - Single Circuit E - Emergency (entire fixture or row) N - Night Light (entire fixture or row) <i>Circuiting pg. 4</i>	0 - None _FSB - Factory Select Battery _PLL - Bodine 10W Battery _ILL - Iota 10W Battery _FSG - Factory Select ALCR Emergency Control Device _GI - Iota ETS DR, Emergency Control Device _GB - Bodine GTD, Emergency Control Device _E - Emergency Section _N - Night Light Section <i>Battery and Emergency pg. 5</i>	W - White S - Metallic Silver BL - Textured Black BR - Bronze GR - Graphite CC - Custom Color <i>Finish pg. 5</i>

CONTROLS

Pinnacle is able to accommodate different control solutions from different manufacturers. Consult factory for more information.

¹When specifying CRI, CCT & OUTPUT the first _ is for specifying either 8 - 80CRI or 9 - 90CRI. The ending __ are for specifying output, example HO - High Output. See output charts for more information. ²Individual fixtures come in 2', 3', 4', 5', 6', 7', & 8' lengths. Continuous row comes in 1' increments. When specifying patterns specified length will be fixture length. Patterns will be longer than specified length. ³Specify CAC length standard CAC is 48". Example: CAC48JB. Specify grid: G1=15/16", G9=9/16", GS=Screw Slot. Example: CAC48G1. ⁴Enter quantity for Battery and Emergency, Example 1PLL. Emergency and Night Light section will be entire fixture within row.

Specifications and dimensions subject to change without notice. Specification sheets that appear on pinnacle-ltg.com are the most recent version and supersede all other previously printed or electronic versions.



Output

- Specify either 80 or 90 CRI
- Longer lead-time may apply for 90 CRI consult factory
- 90 CRI = R9≥61

Custom Output - Lumens OR Wattage

CL _____	Specify CRI, CCT and desired lumens (i.e. CL835500)	Max lumens approximately 1250 lumens/ft, consult factory for more information
CW _____	Specify CRI, CCT and desired wattage (i.e. CW9407)	Specify watts between standard offering listed below

80 CRI

	Color	Output	Lumens per foot		
				LPW	Watts/ft
830LO	3000K	Low	500	116	4.3
830MO	3000K	Medium	750	116	6.5
830HO	3000K	High	1000	117	8.6
835LO	3500K	Low	500	119	4.2
835MO	3500K	Medium	750	119	6.3
835HO	3500K	High	1000	120	8.3
840LO	4000K	Low	500	121	4.1
840MO	4000K	Medium	750	121	6.2
840HO	4000K	High	1000	122	8.2

90 CRI

927LO	2700K	Low	500	95	5.3
927MO	2700K	Medium	750	96	7.8
927HO	2700K	High	1000	95	10.5
930LO	3000K	Low	500	98	5.1
930MO	3000K	Medium	750	99	7.6
930HO	3000K	High	1000	98	10.2
935LO	3500K	Low	500	100	5.0
935MO	3500K	Medium	750	101	7.5
935HO	3500K	High	1000	100	10.0
940LO	4000K	Low	500	103	4.9
940MO	4000K	Medium	750	103	7.3
940HO	4000K	High	1000	103	9.7

Length

- All individual units cannot be joined, end plates are factory installed and cannot be removed
- End plates add 4" (2" per end) to the overall length of the fixture/row
- For patterns, refer to Pattern section on next page

2	3	4	5	6	7	8	-
Indiv. Fixture	Indiv. Fixture	Indiv. Fixture	Indiv. Fixture	Indiv. Fixture	Indiv. Fixture	Indiv. Fixture	Cont. Run Specify nominal overall row length to the 1'
24" (609.6mm)							
	36" (914.4mm)						
		48" (1219.2mm)					
			60" (1524mm)				
				72" (1828.8mm)			
					84" (2133.6mm)		
						96" (2438.4mm)	
							Specify to the 1' >>>



Patterns

- Specify pattern shape and requested fixture length
- Length specified will not reflect overall pattern dimensions
- Angles and shapes not shown require MOD Pattern; consult factory
- All connectors are NON-ILLUMINATED
- Minimum length for any single part of a pattern is 2'
- All lengths are TO THE FOOT ONLY
- Our in house milling capabilities enable the design and development of any non-standard connector.
- Example part number: S3U-835HO-Y8x6x8-CAC48JB-U-FSD-1-0-GR
- Connectors add to the overall length of the pattern

S_	R_x_	U_x_x_	L_x_	Y_x_x_	X_x_x_x_	MOD
Square Provide A dimension Example: S4'	Rectangle Provide AxB dimensions Example: R4'x3'	U-Shape Provide AxBxC dimensions Example: U3'x4'x3'	L-Shape Provide AxB dimensions Example: L3'x3'	Y-Shape Provide AxBxC dimensions Example: Y3'x3'x3'	X-Shape Provide AxBxCxD dimensions Example: X3'x3'x3'x3'	Multi Connector Layout For patterns other than shown, factory drawing and sign off required with all MODs

Non-illuminated Connector Details

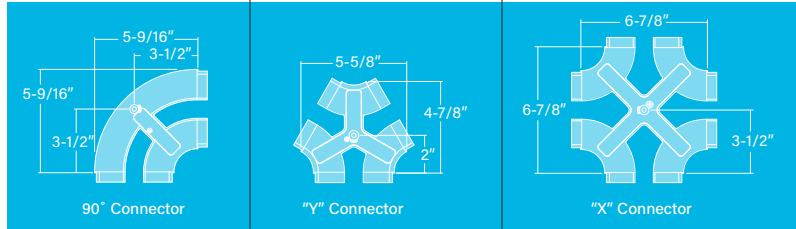

Mounting

- Adjustable cable. Specify 48", 120", 240", or 350"
- Specify cable length in ordering code
- End plates attached at factory
- Canopies and mounts match fixture finish. See Finish section for additional details
- Approved for dry/damp location unless otherwise noted
- Refer to installation instructions during installation
- Maximum fixture weight is 8 lbs for a standard 4' fixture
- Driver/Battery Count dictated by product configuration

CAC__G_ Conductive AC to Grid (specify grid type: G1, G9, GS)
CAC__JB Conductive AC to Junction Box

Mounting Details

- CAC is an integrated power and suspension cable that is smaller in diameter than a traditional SJT cable. CAC is 2 or 4 conductive cables and suspension, standard power cable (SJT) is 5 conductive cables and no suspension.

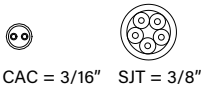

- A larger power side canopy allows for adjustability of the CAC cable inside of the canopy.

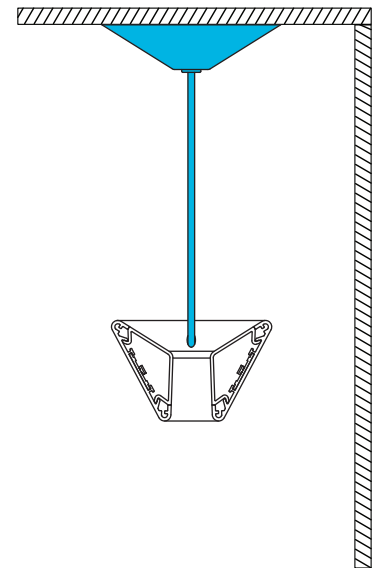
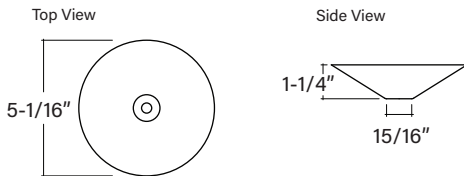



Voltage

- Some SORREL configurations will not accommodate all voltage options; consult with factory

U	Universal
1	120 volt
2	277 volt
3	347 volt

Remote Driver

- Driver count dictated by product configuration
- Standard Driver Option = FSD
- Driver Lifetime: 50,000 hours at 25°C ambient operating conditions
- For more driver options, see Pinnacle Resource Guide
- Some SORREL configurations will not accommodate all driver options; consult with factory
- Configurations with multiple drivers will require Standard Remote Box

0-10V Drivers

FSD	Factory Select Driver, 1%, 0-10v
PL2	Advance Xitanium, 1%, 0-10v
PL4	Advance Xitanium 347v, 1%, 0-10v (requires 347v option)
OL2	eldoLED Optotronic, 1%, 0-10v
OL4	eldoLED Optotronic 347v, 1% 0-10v (requires 347v option)
EE1	eldoLED ECOdrive 1%, 0-10v (logarithmic)
EE2	eldoLED ECOdrive 1%, 0-10v (linear)
ES1	eldoLED SOLOdrive 0%, 0-10v (logarithmic)
ES2	eldoLED SOLOdrive 0%, 0-10v (linear)

DALI Drivers

EE3	eldoLED SOLOdrive .1%, DALI 2, DT6 (logarithmic)
EE4	eldoLED SOLOdrive .1%, DALI 2, DT6 (linear)

Lutron Drivers

LH1	Lutron Hi-lume Soft-on, Fade-to-Black 1%, EcoSystem, LDE1
------------	---

Slim Remote Box

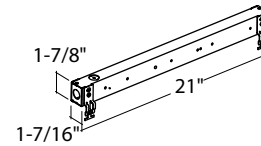

Standard Remote Box

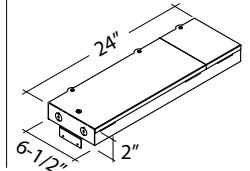

How to specify Circuiting, Battery and Emergency

- Select fixture circuiting from options below
 - Some SORREL configurations will not accommodate all circuiting options, consult with factory

Circuiting

1	Single Circuit
E	Emergency Circuit entire fixture or row
N	Night Light Circuit entire fixture or row



- Battery and emergency options are available in addition to fixture circuit
- Select battery and emergency options below; factory shop drawing required
- Some SORREL configurations will not accommodate all circuiting options, consult with factory
- Configurations with battery or emergency device will require Standard Remote Box

Battery and/or Emergency

0 No battery or specific emergency required

Battery

- Battery is REMOTE
- Select battery type if required, indicate total QTY. *Example 2PLL*
- 90 minute battery runtime; test button is remote to fixture
- Battery operates full length of housing up to 8' on individual fixtures or within continuous row
- For more battery options available, see Pinnacle Resource Guide

0	No battery
_FSB	Factory Select Battery (10w option, remote in box)
_FSBST	Factory Select Battery (Self Testing, remote in box)
_ILL	Iota 10W (low profile, remote in box)
_IRC	Iota 10W (remote with conduit)
_PLL	Philips Bodine 10W (low profile, remote in box)
_PRD	Philips Bodine 10W (remote with conduit)

Standard Remote Box

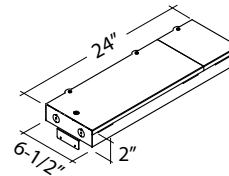

For Approximate Battery Lumen Output

- Multiply battery wattage X fixture LPW shown on Lumen Table
- 92.3 (LPW) x 10 (watts) = 923 battery lumen output

Emergency

- Emergency Control Device REMOTE in driver box
- Select emergency section type if required, indicate total QTY. *Example 1E*
- Combine battery and emergency section ordering codes if both options are selected
- Emergency circuiting sections are for use when specifying emergency options on continuous runs

_FSG	Factory Select ALCR Emergency Control Device, UNV
_GI	Iota ETS-DR, Emergency Control Device, UNV
_GB	Bodine GTD, Emergency Control Device, 120v or 277v
_E	Emergency circuit
_N	Night Light circuit
_L	Life Safety circuit section NO THROUGH WIRE

Battery OR Emergency Ordering Examples

- Single circuit, 10w Integral Battery Ordering Code: 1-1PLL
- Emergency only, 10w Integral Battery Ordering Code: E-1PLL
- Single circuit, GTD required Ordering Code: 1-1GB

Finish

- Standard powder-coat textured white, metallic silver, textured black, graphite or bronze painted finish; consult factory for chip of standard paint finishes
- Selecting a fixture finish other than white may impact lumen output; consult factory for more information

W	White (white cord/white canopy)
S	Metallic Silver (grey cord/silver canopy)
BL	Textured Black (black cord/black canopy)
BR	Bronze (white cord/bronze canopy)
GR	Graphite (white cord/graphite canopy)
CC	Custom Color (white cord/custom color canopy to match fixture)

Controls

- Pinnacle is able to use solutions from different manufacturers. Consult factory for more information.

Specifications and dimensions subject to change without notice. Specification sheets that appear on pinnacle-ltg.com are the most recent version and supersede all other previously printed or electronic versions.



Photometrics

Satine Lens

Test # REP-052322-01
 Catalog # S3U-840HO
 Lumens 4015
 Watts 32.8
 Efficacy 122.4

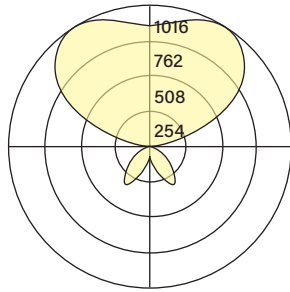

Distribution is 18% direct / 82% indirect

Candela Distribution

Vert Angle	Horizontal Angle				
	0	22.5	45	67.5	90
0	69	69	69	69	69
5	68	69	74	79	83
15	66	87	135	169	183
25	62	117	205	267	291
35	55	147	274	294	289
45	48	177	245	220	207
55	40	164	165	134	124
65	31	126	87	68	63
75	22	58	33	27	25
85	12	8	4	3	2
90	3	4	3	2	2
95	46	61	43	34	30
105	173	283	263	243	239
115	324	471	515	493	478
125	463	613	714	722	724
135	589	719	846	884	892
145	699	791	907	973	989
155	783	842	916	974	994
165	841	870	905	936	946
175	872	878	880	887	889
180	878	878	878	878	878

Luminance Data (cd/sq.m)

Angle In Degrees	Average 0-Deg	Average 45-Deg	Average 90-Deg
45	730	3733	3144
55	750	3089	2326
65	796	2206	1606
75	919	1373	1032
85	1491	513	243

For all available IES files, please visit our website at pinnacle-ltg.com. Photometry testing in accordance to IESNA-LM-79-08 at an IAS accredited testing laboratory. Testing conducted at 25°C ambient conditions

Applications & Certificates

Construction: 6063-T6 Extruded aluminum housing. Highly reflective die-formed white painted reflector.

Shielding: Diffuse snap-in acrylic lens with matte finish, removable for maintenance.

Mounting: Conductive Aircraft cable mount available. Power mount supplied with conductive aircraft cable and round 5" diameter canopy. Non-power supplied with aircraft cable and 2" (50.8mm) canopy. Refer to installation instructions for appropriate ceiling detail.

LED: 25°C test environment. Lumen output/wattage has a margin of +/- 5%; 2' or 3' lengths may have a greater wattage deviation. Luminaire configurations tested in accordance with IES LM-79. Diodes tested in accordance with IES LM-80. Lifetime calculated using IES TM-21. Minimum lifetime greater than 60,000 hours. Lifetime Projection L70 = 276,000 hours and L90 = 83,800 hours. MacAdam 3-Step Ellipses. For all available IES files, please visit our website at pinnacle-ltg.com.

CRI, CCT & Output: Not all lumen packages available. Three lumen packages available. Low (LO), Medium (MO), High (HO). Custom outputs are available. Specify custom lumens or watts between standard offering listed on CRI, CCT & Output page. 80 CRI is available for 3000K, 3500K, and 4000K. 90 CRI is available for 2700K, 3000K, 3500K and 4000K. 90 CRI = R9≥50.

Voltage: Universal (U), 120 volt (1), 277 volt (2) and 347 volt (3) options available. Must specify PL4 or OL4 in Driver section when 347 volt (3) is selected. Some SORREL configurations will not accommodate all voltage options; consult with factory.

Driver: Standard Driver Option is Factory Select Driver 0-10V, 1% = FSD. Electronic driver, Power factor is >0.9 with a THD <20%. Driver Lifetime: 50,000 hours at 25°C ambient operating conditions. Ambient operating range: -20°F/-30°C to 98°F/37°C. For more driver options, see Pinnacle Resource Guide. Some SORREL configurations will not accommodate all driver options.

Remote Mounting Guide

Distance limited by max input watts shown.

Max Distance	56'	42'	28'	20'	15'
4' Housing	4.0w/ft	5.3w/ft	7.9w/ft	11.0w/ft	14.3w/ft
8' Housing	N/A	2.6w/ft	3.9w/ft	5.4w/ft	7.3w/ft

Circuiting: Select from single circuit (1), Emergency circuit (E) or Night Light circuit (N). Housings cannot be split into multiple circuits. Some SORREL configurations will not accommodate all circuiting options; consult with factory.

Battery & Emergency: Select battery or emergency options if required. If battery or emergency option is not required, enter 0. Battery duration is 90 minutes as standard. Test button is remote to fixture. Standard battery and emergency device options will be installed in standard remote box. For more battery options, see Pinnacle Resource Guide.

Finish: Standard powder-coat textured white, metallic silver, textured black, graphite or bronze painted finish; consult factory for chip of standard paint finishes. Contact factory for additional custom color and finish options.

Controls: Consult factory.

Labels: UL and cUL Listed. Low, Medium and High Output lumen packages are approved for dry/damp location unless otherwise noted.

Fixture Weight: Maximum fixture weight is 8 lbs for a standard 4' fixture.

Buy American Act Compliant Some options are not Buy American Act Compliant, please contact factory for more information.

Warranty: SORREL offered with a 5-year limited warranty. Covers LED, driver and fixture.

Specifications and dimensions subject to change without notice. Specification sheets that appear on pinnacle-ltg.com are the most recent version and supersede all other previously printed or electronic versions.

Designed in Denver, CO • USA | pinnacle-ltg.com | O: 303-322-5570 F: 303-322-5568

S3U_LED_SPEC_SEPT2024