

EDGE EX6
6" Suspended Direct Linear

Key Features

- 6063-T5 Extruded aluminum housing
- Highly reflective die-formed white painted reflector
- Wiring access available through bottom of housing
- 5-year limited warranty covers LED, driver and fixture
- UL and cUL listed
- Approved for dry/damp location unless otherwise noted
- Maximum weight is 25 lbs. for a standard 4' fixture
- Buy American Act compliant



Example Part #: EX6-A-N-830HO-26'-AC48G1-U-OL2-1-0-W

EX6 - **- N** - **-** - **-** - **-** - **-** - **-** - **-** - **-** - **-** - **-** - **-**

DIRECT SHIELDING INDIRECT SHIELDING CRI, CCT & OUTPUT LENGTH OR PATTERN MOUNTING VOLTAGE DRIVER CIRCUITING BATTERY & EMERGENCY FINISH FIXTURE OPTIONS CONTROLS

---	N	-----	-----
DIRECT SHIELDING	INDIRECT SHIELDING	CRI, CCT & OUTPUT ¹	LENGTH OR PATTERN ²
A - Satine Lens AL - Drop Lens R - Flat Regress Shielding pg. 2	N - None Shielding pg. 2	_ 27 _ - 2700K _ 30 _ - 3000K _ 35 _ - 3500K _ 40 _ - 4000K CL _____ - Custom Lumens CW _____ - Custom Watts Lumen Output pg. 2	__ - Individual Fixture _ - Continuous Row S - Square R_X - Rectangle L_X - L Shape U_X - U-Shape M - Mod Layout Length and Pattern pg. 2-3
-----	-	---	-
MOUNTING ³	VOLTAGE	DRIVER	CIRCUITING
_ AC _ G - (M)AC to Grid _ AC _ JB - (M)AC to J Box _ AC _ ST - (M)AC to Structure _ AC5 _ G - 5" Non-Power Canopy _ AC5 _ JB - 5" Non-Power Canopy _ SQ _ G - 5" Square Canopy _ SQ _ JB - 5" Square Canopy WA - Wall Mount S - Surface Mount Mounting pg. 3	U - Universal (120 thru 277V) 1 - 120V 2 - 277V 3 - 347V Voltage pg. 4	FSD - Factory Select Driver (1%, 0-10v) PL2 - Advance Xitanium (1%, 0-10v) OL2 - Osram (1%, 0-10v) OL4 - Osram 347v (1%, 0-10v) EE1 - eldoLED ECOdrive (1%, 0-10v) ES1 - eldoLED SOLOdrive (0.1%, 0-10v) LH1 - Lutron Hi-lume (1%, EcoSystem) PS1 - Advance Xitanium (50%/100%) Driver pg. 4	1 - Single Circuit M - Multi Circuit E - Emergency (entire fixture) N - Night Light (entire fixture) Circuiting pg. 5
---	---	-----	-----
BATTERY & EMERGENCY ⁴	FINISH	FIXTURE OPTIONS ⁵	CONTROLS
0 - None _ FSB - Factory Select Battery _ FSG - Factory Select ALCR _ GI - Iota ETS DR _ GB - Bodine GTD _ IC - Iota 10W Integral (CEC Listed) _ P - Bodine 10W _ E - Emergency Section _ N - Night Light Section _ L - Life Safety Section Battery and Emergency pg. 5	W - White S - Metallic Silver BL - Textured Black BR - Bronze GR - Graphite CC - Custom Color Finish pg. 5	MRF - Fixed MR16 (Halogen) LMRF - Fixed MR16 (LED) XLED - Fixed Xicato (LED) MRA - Adjustable MR16 (Halogen) DSP - Customer Supplied Battery/Driver/Sensor LMRA - Adjustable MR16 (LED) Fixture Options pg. 5	Pinnacle is able to accommodate different control solutions from different manufacturers. Consult Factory for more information.

¹When specifying CRI- CCT & OUTPUT the first _ is for specifying either **8** - 80CRI or **9** - 90CRI. The ending __ are for specifying output, example **HO** - High Output. See output charts for more information. ²Individual fixtures come in 2', 3', 4', 5', 6' & 8' lengths. Continuous row come in 1' increments. For Mod layouts specify pattern shape and overall dimensions. Example: L6x4: L pattern that is 6'x4'. ³Specify AC Cable: Standard single AC = AC or Movable AC = MAC; Specify AC length standard AC is 48"; Specify grid: G1=15/16", G9=9/16", GS=Screw Slot. Example: AC48G1 ⁴Enter quantity for Battery and Emergency, Example 2P. ⁵MRF, and LMRF options not available with 277v.

Specifications and dimensions subject to change without notice. Specification sheets that appear on pinnacle-ltg.com are the most recent version and supersede all other previously printed or electronic versions.



Direct Shielding

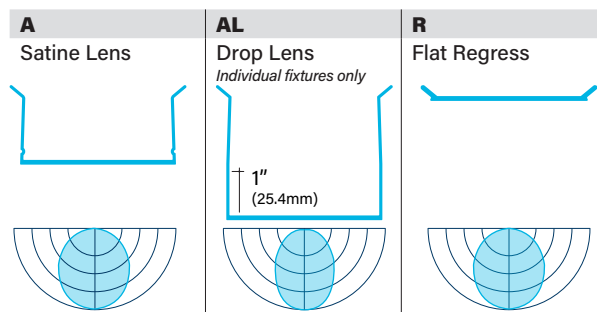

Indirect Shielding



Output

- Specify either 80 or 90 CRI
- Longer lead-time may apply for 90 CRI. Consult factory.
- 90 CRI = R9≥50

Custom Output- Lumens OR Wattage

CL _____	Specify CRI, CCT and desired lumens (i.e. CL835600)	Specify lumens between standard offering listed below. Lumens are specified per color temp
CW _____	Specify CRI, CCT and desired wattage (i.e. CW9407)	Specify watts between standard offering listed below

80 CRI

	Color	Output	Watts per foot	Shielding					
				A Satine		AL Drop		R Flat Regress	
				Lumens/ft	LPW	Lumens/ft	LPW	Lumens/ft	LPW
830	3000K	Standard	4.6	421	91.0	469	101.4	421	91.0
830HO	3000K	High	8.5	779	91.4	866	101.5	779	91.4
835	3500K	Standard	4.6	433	93.6	483	104.3	433	93.6
835HO	3500K	High	8.5	801	94.0	890	104.4	801	94.0
840	4000K	Standard	4.6	441	95.4	492	106.3	441	95.4
840HO	4000K	High	8.5	817	95.8	907	106.4	817	95.8

90 CRI

927	2700K	Standard	4.6	332	71.8	371	80.1	332	71.8
927HO	2700K	High	8.5	615	72.1	684	80.2	615	72.1
930	3000K	Standard	4.6	388	83.9	432	93.4	388	83.9
930HO	3000K	High	8.5	718	84.2	798	93.6	718	84.2
935	3500K	Standard	4.6	390	84.3	434	93.8	390	84.3
935HO	3500K	High	8.5	721	84.6	801	94.0	721	84.6
940	4000K	Standard	4.6	394	85.2	439	94.9	394	85.2
940HO	4000K	High	8.5	729	85.5	810	95.0	729	85.5

Length

- All individual units cannot be joined, end plates are factory installed and cannot be removed
- For continuous runs, add 1/4" (6.4mm) for each end plate or 1/2" (12.7mm) to the overall length of the row
- For patterns, refer to Pattern section on next page

2	3	4	5	6	8	—
Indiv. Fixture	Indiv. Fixture	Indiv. Fixture	Indiv. Fixture	Indiv. Fixture	Indiv. Fixture	Cont. Run
24" (609.6mm)						Specify nominal overall row length to the 1'
36" (914.4mm)						
48" (1219.2mm)						
60" (1524mm)						
72" (1828.8mm)						
96" (2438.4mm)						

Specify to the 1' >>>

Specifications and dimensions subject to change without notice. Specification sheets that appear on pinnacle-ltg.com are the most recent version and supersede all other previously printed or electronic versions.



Pattern

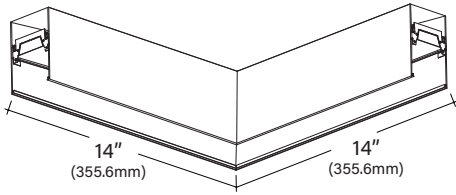

- Specify pattern shape and overall dimensions (includes corner dimensions)
- Refer to dimensions table below for available standard lengths
- All connectors are direct only
- 90 degree horizontal corners are 14"x14" (overall, outside dimension)
- Angles and shapes not shown require Mod Pattern; consult factory
- Only available with "A" lens options
- Not all drivers available with all patterns; consult factory

S	R x	U x x	L x	M
Square Provide A dimension Example: S4' Nominal Lengths 4'x4' Minimal Length- 4'4"x4'4"	Rectangle Provide AxB dimensions Example: R4'x4' Nominal Lengths 4'x4' Minimal Length- 4'4"x4'4"	U-Shape Provide AxBxC dimensions Example: U3'x4'x2' Nominal Lengths 3'x4'x3' Minimal Length- 4'4"x3'2"x3'2"	L-Shape Provide AxB dimensions Example: L3'x3' Nominal Lengths 3'x3' Minimal Length- 3'2"x3'2"	Mod Layout For patterns or lengths not shown or standard

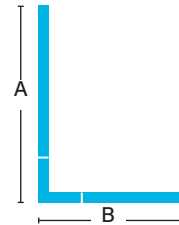
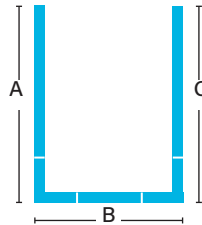
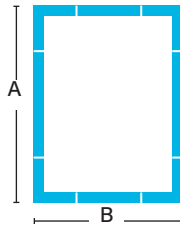
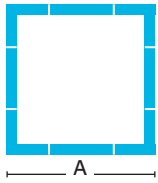

Mounting

- Specify cable length in ordering code (AC48G1)
- Standard adjustable cable. Specify 48", 120", 240" or 350"
- End trims and power cord attached at factory
- Aircraft cable (AC) mounts on 4" (1219.2mm) and 8" (2438.4mm) centers
- Aircraft Cable supplied with 5" (127mm) power and 2" (50.8mm) non-power canopies

- Canopies and pendants match fixture finish, power cords are white, grey, or black depending on fixture finish. See Finish section for additional details.
- Approved for dry/damp location unless otherwise noted
- Refer to installation instructions during installation at the job site
- Maximum fixture weight is 25 lbs for a standard 4' fixture

AC_G1	Aircraft Cable 1" (15/16") T-Bar
AC_G9	Aircraft Cable 9/16" T-Bar
AC_GS	Aircraft Cable Screw Slot T-Bar
AC_JB	Aircraft Cable Junction Box
AC_ST	Aircraft Cable Structure
AC5_G	Aircraft Cable 5" (127mm) Non-Power Canopy
AC5_JB	Aircraft Cable 5" (127mm) Non-Power Canopy
SQ_G	Aircraft Cable 5" (127mm) Square Canopy
SQ_JB	Aircraft Cable 5" (127mm) Square Canopy
MAC_G1	Moveable AC 1" (15/16") T-Bar
MAC_G9	Moveable AC 9/16" T-Bar
MAC_GS	Moveable AC Screw Slot T-Bar
MAC_JB	Moveable AC Junction Box
MAC_ST	Moveable AC Structure
MAC5_G	Moveable AC 5" (127mm) Non-Power Canopy
MAC5_JB	Moveable AC 5" (127mm) Non-Power Canopy
MSQ_G	Moveable AC 5" (127mm) Square Canopy
MSQ_JB	Moveable AC 5" (127mm) Square Canopy
WA	Wall Mount
S	Surface Mount

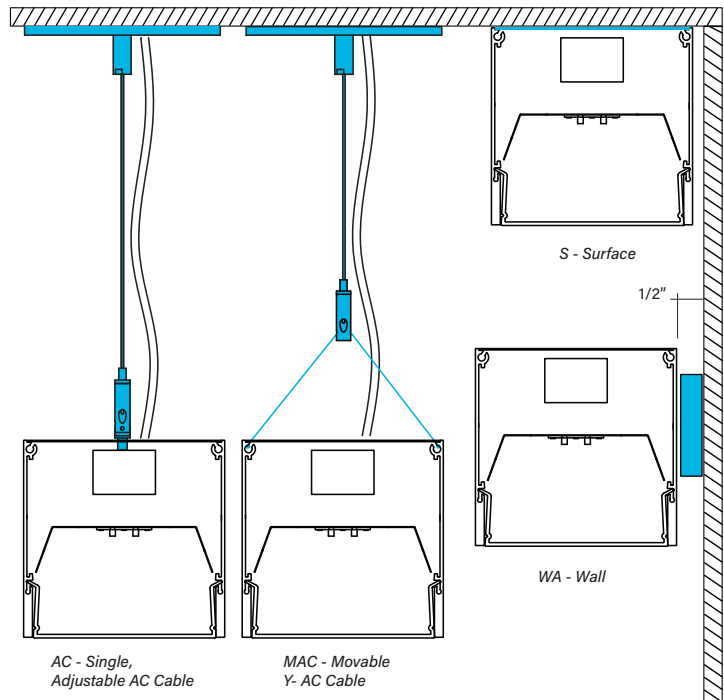

Specifications and dimensions subject to change without notice. Specification sheets that appear on pinnacle-ltg.com are the most recent version and supersede all other previously printed or electronic versions.



Voltage

- Some EX6 configurations will not accommodate all voltage options; consult with factory

U	Universal
1	120 volt
2	277 volt
3	347 volt

Driver

- Standard Driver Option = FSD
- Driver Lifetime: 50,000 hours at 25°C ambient operating conditions
- For more driver options see Pinnacle Resource Guide
- Some EX6 configurations will not accommodate all driver options; consult with factory

0-10V Drivers

FSD	Factory Select Driver 1%, 0-10v
PL2	Signify Advance Xitanium 1%, 0-10v
PL4	Advance Xitanium 347v 1%, 0-10v, requires 347v
OL2	Osram Optotronic, 1%, 0-10v
OL4	Osram Optotronic 347v, 1% 0-10v, requires 347v option
EE1	eldoLED ECOdrive 1%, 0-10v Logarithmic
EE2	eldoLED ECOdrive 1%, 0-10v Linear
ES1	eldoLED SOLOdrive 0-10v, 0.1% Logarithmic
ES2	eldoLED SOLOdrive 0-10v, 0% Linear

DALI Drivers

EE3	eldoLED ECOdrive .1%, DALI (logarithmic)
ES3	eldoLED SOLOdrive .1%, DALI (logarithmic)
OD1	Osram Optotronic 1%, DEXAL
OD2	Osram Optotronic 1%, DALI 2 Channel

Lutron Drivers

LH1	Lutron Hi-lume Soft-on, Fade-to-black 1%, EcoSystem, LDE1
LH4	Lutron Hi-Lume 1%, 2-wire, Lutron-LTEA2W, 120v only

Alternate Drivers

PS1	Signify Advance Xitanium Step Dimming 50%/100%
EH1	ELV 120v only, 0-10v universal

How to specify Circuiting, Battery and Emergency

- Select fixture circuiting from options below
 - Some EX6 configurations will not accommodate all circuiting options, consult with factory

Circuiting

1	Single Circuit
M	Multi Circuit
E	Emergency Circuit only
N	Night Light Circuit only

- Battery and emergency section options are available in addition to fixture circuit
 - Select battery and emergency section options below; factory shop drawing required
 - Some EX6 configurations will not accommodate all circuiting options, consult with factory

Battery and/or Emergency If Required

0	No battery or specific emergency section required
----------	---



Battery

- Select battery section type if required, indicate total QTY. *Example 2P*
- 90 minute battery runtime; test button is remote to fixture and requires an additional drop
- No battery option available for 2' lengths
- Entire direct fixture housing is on battery for lengths up to 5'
- Half of direct fixture is on battery for 6' or 8' housing lengths
- For more battery options available, see Pinnacle Resource Guide

0	No Battery
_FSB	Factory Select Battery (10w option)
_FSBST	Factory Select Battery (10w, Self Testing)
_IC	lota 10w Integral
_ILL	lota 10w Integral Lithium, Self Testing
_IRH	lota 20w Remote
_P	Bodine 10w Integral
_PRH	Bodine 20w Remote
_PLL	Bodine 10w Integral Lithium, Self Testing

For Approximate Battery Lumen Output

- Multiply battery wattage X fixture LPW shown on Lumen Table
- 92.3 (LPW) x 10 (watts) = 923 battery lumen output

Emergency

- Select emergency section type if required, indicate total QTY. *Example 1E*
- Combine battery and emergency section ordering codes if both options are selected

_FSG	Factory Select Automatic Load Control Relay (ALCR), UNV
_GI	Emergency Transfer Switch (ETS) DR Emergency Control Device, UNV
_GB	Bodine GTD, Generator Transfer Device, 120v or 277v
_E	Emergency circuit section
_N	Night Light circuit section
_L	Life Safety circuit section NO THROUGH WIRE

Battery OR Emergency Ordering Examples

- Single circuit, 10w Integral Battery Ordering Code: 1-1P
- Emergency only, 10w Integral Battery Ordering Code: E-1P
- Single circuit, GTD required Ordering Code: 1-1G

Combination Section Ordering Examples

- Single circuit, (1) 10w battery, (1) emergency section Ordering Code: 1-1P1E
- Multi circuit, (2) 10w battery, (2) emergency sections Ordering Code: M-2P2E
- Single circuit, (1) night light section Ordering Code: 1-1N

Finish

- Standard powder-coat textured white, metallic silver, textured black, graphite or bronze painted finish; consult factory for chip of standard paint finishes
- Selecting a fixture finish other than white may impact lumen output; consult factory for more information

W	White (<i>white cord/white canopy</i>)
S	Metallic Silver (<i>grey cord/silver canopy</i>)
BL	Textured Black (<i>black cord/black canopy</i>)
BR	Bronze (<i>white cord/bronze canopy</i>)
GR	Graphite (<i>white cord/graphite canopy</i>)
CC	Custom Color (<i>white cord/color match canopy</i>)

Fixture Options

- Additional options to enhance the fixture and finish of the product
- Consult factory for MR16 configurations
- Specify CC-C to match housing. If not specified, canopy will be standard matte white.

MRF	Fixed MR16 Halogen
LMRF	Fixed MR16 LED
XLED	Fixed Xicato LED
MRA	Adjustable MR16 Halogen
DSP	Customer Supplied Battery/Driver/Sensor
LMRA	Adjustable MR16 LED

Controls

- Pinnacle is able to accommodate different control solutions from different manufacturers. Consult Factory for more information.

Specifications and dimensions subject to change without notice. Specification sheets that appear on pinnacle-ltg.com are the most recent version and supersede all other previously printed or electronic versions.



Photometrics

Satine Lens

Test #	ITL86802
Catalog #	EX6A-840-4
Lumens	1724 lm
Watts	18.5 W
Efficacy	93 LPW

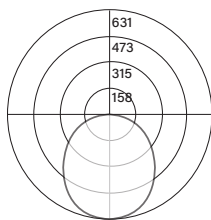

Candela Distribution

Vert Angle	Horizontal Angle				
	0	22.5	45	67.5	90
0	631	631	631	631	631
5	627	627	627	627	627
10	619	616	616	616	615
15	602	598	599	599	596
20	582	575	578	575	574
25	553	546	548	545	543
30	521	514	516	512	508
35	483	476	477	473	470
40	442	436	436	432	429
45	399	393	393	389	386
50	354	350	348	344	343
55	308	304	303	300	298
60	261	257	256	254	253
65	213	211	209	207	207
70	167	165	163	162	162
75	121	119	118	118	118
80	78	77	76	75	75
85	38	37	37	36	36
90	0	0	0	0	0

Luminance Data (cd/sq.m)

Angle In Degrees	Average 0-Deg	Average 45-Deg	Average 90-Deg
45	3722	3666	3599
55	3535	3477	3418
65	3321	3257	3225
75	3087	3009	3009
85	2851	2774	2697

For all available IES files, please visit our website at pinnacle-ltg.com. Photometry testing in accordance to IESNA-LM-79-08 at an NVLAP accredited testing laboratory. Testing conducted at 25°C ambient conditions

Applications & Certificates

Construction: 6063-T5 Extruded aluminum housing. Highly reflective die-formed white painted reflector.

Shielding: Diffuse snap-in acrylic lens, removable for maintenance.

Mounting: Aircraft cable and wall mount available. Select from 2 aircraft cable options. Select the straight aircraft cable that mounts on 4'-0" (1219.2mm) and 8'-0" (2438.4mm) centers or the moveable adjustable Y-cable mount. The Y-Cable design allows for adjustable mounting locations. Aircraft Cable supplied with 5" (127mm) power and 2" (50.8mm) non-power canopies. Refer to installation instructions for appropriate ceiling detail. Canopies are painted white unless otherwise specified. Maximum fixture weight is 24 lbs. for a standard 4' fixture.

LED: 25°C test environment. Lumen output/wattage has a margin of +/- 5%; 2' or 3' lengths may have a greater wattage deviation. Luminaire configurations tested in accordance with IES LM-79. Diodes tested in accordance with IES LM-80. Lifetime calculated using IES TM-21. Minimum lifetime greater than 60,000 hours. L70 = 136,200 hours and L90 = 41,100 hours. MacAdam 3-Step Ellipses. Not all products are Lighting Facts listed. For all available IES files, please visit our website at pinnacle-ltg.com.

CRI, CCT & Output: Two lumen packages available. Standard and High (HO). Custom outputs are available. Specify custom lumens or watts between standard offering listed on CRI, CCT & Output page. 80 CRI is available for 3000K, 3500K, and 4000K. 90 CRI is available for 2700K, 3000K, 3500K, and 4000K. 90 CRI = R9≥50.

Voltage: Universal (U), 120 volt (1), 277 volt (2) and 347 volt (3) options available. Must specify OL4 in Driver section when 347 volt (3) is selected. Some EX configurations will not accommodate all voltage options; consult with factory.

Driver: Standard Driver Option is Advance Xitanium 0-10V, 1% = PL2. Electronic driver, Power factor is >0.9 with a THD <20%. Driver Lifetime: 50,000 hours at 25°C ambient operating conditions. Ambient operating range: -20°F/-30°C to 127°F/53°C. For more driver options, see Pinnacle Resource Guide. Some EX configurations will not accommodate all driver options.

Circuiting: Select from single circuit (1), Multi circuit (M), Emergency circuit (E) or Night Light circuit (N). For emergency circuiting situations that require no through wire or circuit separation, Life Safety Circuit should be selected. This will provide a separate power feed and only the Life Safety Circuit in that section. Some EX configurations will not accommodate all circuiting options, consult with factory.

Battery & Emergency: Select battery or emergency options if required. If battery or emergency option is not required, enter 0. Battery duration is 90 minutes as standard. Test button is remote to fixture. For more Battery options, see Pinnacle Resource Guide.

Finish: Standard powder-coat textured white, metallic silver, textured black, graphite or bronze painted finish; consult factory for chip of standard paint finishes. Canopies painted white unless specified differently in the options section of the part number. Contact factory for additional custom color and finish options.

MR16: Ideal for conference rooms, corridors, wall washing, retail spaces and training facilities where accent lighting is required. Fully enclosed compartment eliminates light from entering into our fixture areas. For LED and Halogen lamps (lamps are not included). Consult factory for other lamp types. Standard 60 watt max LED electronic transformer (120v), 50 watt max halogen lamp electronic transformer (120v), MR16 installed as an independent circuit. MR16 to match fixture voltage. 277v not available. Consult factory for MR16 configurations. Pinnacle's MR16 applications are to be used with Soraa lamps with a maximum of 13 transformers on one circuit.

Controls: Consult factory.

Labels: UL and cUL 1598 listed. Standard and HO lumen packages are approved for dry/damp location unless otherwise noted.

Fixture Weight: Maximum fixture weight is 25 lbs. for a standard 4' fixture.

Buy American Act Compliant

Warranty: EX LED offered with a 5-year limited warranty. Covers LED, driver and fixture.