

# EDGE EV1

## 1" Recessed Linear

### Key Features

- Extruded aluminum trim with formed cold rolled 18 gauge steel back box housing
- Highly reflective die-formed white painted steel reflector
- 5-year limited warranty covers LED, driver and fixture
- UL and cUL listed. IC rated
- Approved for dry/damp location unless otherwise noted
- Room-Side Maintenance for LED system
- Buy American Act compliant



Example Part #: EV1-HE-830HO-26'-G1-U-OL2-1-0-W

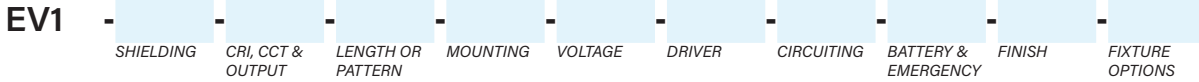

SHIELDING	SOURCE <sup>1</sup>	LENGTH OR PATTERN <sup>2</sup>	MOUNTING <sup>3</sup>
<b>A</b> - Satine Lens <b>HE</b> - High Efficiency Lens <b>BW</b> - Batwing Insert in HE Lens <b>WHE</b> - Asymmetric Insert in HE Lens <b>HED</b> - Descent High Efficiency Lens <b>P</b> - Parabolic Louver with Lens Overlay <i>Shielding pg. 2</i>	<b>_27_</b> - 2700K <b>_30_</b> - 3000K <b>_35_</b> - 3500K <b>_40_</b> - 4000K <b>CL</b> - Custom Lumens <b>CW</b> - Custom Watts <b>MOD</b> - Mod options available <i>Lumen Output pg. 2</i>	<b>_</b> - Individual Fixture <b>_</b> - Continuous Row <b>L_x_</b> - L Shape <b>R_x_</b> - Rectangle <b>T_x_</b> - T-Shape <b>S_</b> - Square <b>U_x_</b> - U-Shape <b>X_x_x_</b> - X-Shape <b>WC_x_</b> - Wall to Ceiling <b>MOD</b> - Mod options available <i>Length and Pattern pg. 3</i>	<b>G1</b> - 1" (15/16") T Bar <b>G9</b> - 9/16" T Bar <b>GB</b> - 9/16" Bevel T Bar <b>GS</b> - Screw Slot T Bar <b>FL</b> - 1/2" Flange <b>NF</b> - Non Flange <b>SF</b> - Spackle Flange <b>MOD</b> - Mod options available <i>Mounting pg. 4</i>
VOLTAGE	DRIVER	CIRCUITING	BATTERY & EMERGENCY <sup>4</sup>
<b>U</b> - Universal (120 thru 277V) <b>1</b> - 120V <b>2</b> - 277V <b>3</b> - 347V <i>Voltage pg. 4</i>	<b>FSD</b> - Factory Select Driver (1%, 0-10v) <b>PL2</b> - Advance Xitanium (1%, 0-10v) <b>OL2</b> - Osram (1%, 0-10v) <b>OL4</b> - Osram 347V (1%, 0-10v) <b>EE1</b> - eldoLED ECOdrive (1%, 0-10v) <b>ES1</b> - eldoLED SOLOdrive (0.1%, 0-10v) <b>LH1</b> - Lutron Hi-lume (1%, EcoSystem) <b>PS1</b> - Advance Xitanium (50%/100%) <b>MOD</b> - Mod options available <i>Driver pg. 5</i>	<b>1</b> - Single Circuit <b>M</b> - Multi Circuit <b>E</b> - Emergency (entire fixture) <b>N</b> - Night Light (entire fixture) <i>Circuiting pg. 5</i>	<b>0</b> - None <b>_FSB</b> - Factory Select Battery <b>_FSG</b> - Factory Select ALCR <b>_G1</b> - Iota ETS DR <b>_GB</b> - Bodine GTD <b>_PL</b> - Bodine 10W (low profile) <b>_E</b> - Emergency Circuit Section <b>_N</b> - Night Light Circuit Section <b>_L</b> - Life Safety Circuit Section <i>Battery and Emergency pg. 6</i>
FINISH	FIXTURE OPTIONS	CONTROLS	
<b>W</b> - White <b>S</b> - Metallic Silver <b>BL</b> - Textured Black <b>BR</b> - Bronze <b>GR</b> - Graphite <b>CC</b> - Custom Color <i>Finish pg. 6</i>	<b>FIL</b> - Field Cut Illuminated Extension <b>CP</b> - Chicago Plenum <b>PM</b> - Perimeter Mount <b>RC</b> - Rotating Crossbar <b>GLR</b> - Internal Fast Blow Fuse <b>DSP</b> - Customer Supplied Battery/Driver/Sensor <b>FW6</b> - 6' Flex Whip <i>Fixture Options pg. 6</i>	<i>Pinnacle is able to accommodate different control solutions from different manufacturers. Consult Factory for more information.</i>	

<sup>1</sup>When specifying CRI, CCT & OUTPUT the first \_ is for specifying either **8** - 80CRI or **9** - 90CRI. The ending \_\_ are for specifying output, example **HO** - High Output. See output charts for more information. <sup>2</sup>Individual fixtures come in 2', 3', 4', 5', 6', 7', & 8' lengths. Continuous row come in 1/8" increments. For Patterns specify pattern shape and overall dimensions. Example: L6x4: L pattern that is 6'x4'. <sup>3</sup>Specify grid for individual or continuous length: G1, G9 & GS for continuous rows, G1G, G9G & GSG for individual lengths. \*Enter quantity for Battery and Emergency, Example 2BS.

Specifications and dimensions subject to change without notice. Specification sheets that appear on pinnacle-ltg.com are the most recent version and supersede all other previously printed or electronic versions.



Shielding

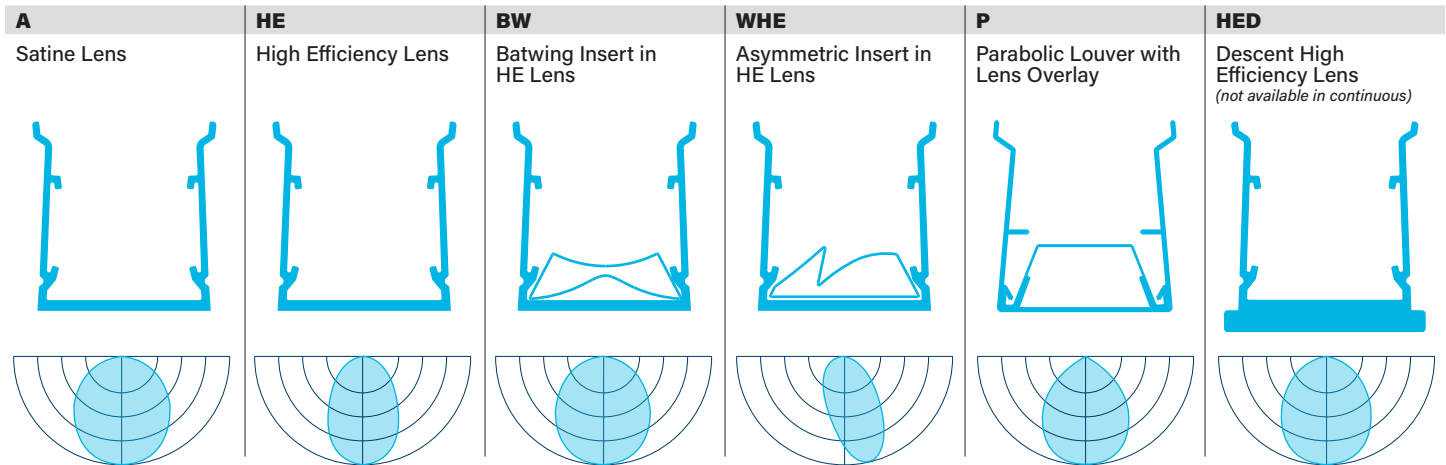

CRI, CCT & Output

- Specify either 80 or 90 CRI
- Longer lead-time may apply for 90 CRI. Consult factory
- 90 CRI = R9≥50

Custom Output - Lumens OR Wattage

**CL**\_\_\_\_\_ Specify CRI, CCT and desired lumens (i.e. CL835500)

Specify lumens between standard offering listed below. Lumens are specified per color temp

**CW**\_\_\_\_\_ Specify CRI, CCT and desired wattage (i.e. CW9407)

Specify watts between standard offering listed below

80 CRI

	Color	Output	Watts per foot	Shielding											
				A Satine Lens		HE High Efficiency		BW Batwing		WHE Asymmetric		P Louver		HED Descent	
				Lumens/ft	LPW	Lumens/ft	LPW	Lumens/ft	LPW	Lumens/ft	LPW	Lumens/ft	LPW	Lumens/ft	LPW
<b>830</b>	3000K	Standard	4.5	347	77.1	412	91.6	327	72.7	365	81.1	273	60.7	377	83.8
<b>830HO</b>	3000K	High	8.6	641	74.5	761	88.5	604	70.2	676	78.6	504	58.6	698	81.2
<b>835</b>	3500K	Standard	4.5	357	79.3	424	94.2	336	74.7	376	83.6	281	62.4	388	86.2
<b>835HO</b>	3500K	High	8.6	658	76.6	782	90.9	621	72.2	695	80.8	519	60.3	717	83.4
<b>840</b>	4000K	Standard	4.5	365	81.0	432	96.0	343	76.2	383	85.1	286	63.6	396	88.0
<b>840HO</b>	4000K	High	8.6	670	77.8	797	92.7	633	73.6	708	82.3	529	61.5	731	85.0

90 CRI

<b>927</b>	2700K	Standard	4.5	274	60.8	325	72.2	259	57.6	289	64.2	216	48.0	298	66.2
<b>927HO</b>	2700K	High	8.6	506	58.8	601	69.9	478	55.6	534	62.1	399	46.4	551	64.1
<b>930</b>	3000K	Standard	4.5	320	71.1	380	84.4	302	67.1	337	74.9	252	56.0	348	77.3
<b>930HO</b>	3000K	High	8.6	591	68.7	701	81.5	557	64.8	623	72.4	465	54.1	643	74.8
<b>935</b>	3500K	Standard	4.5	321	71.3	382	84.9	303	67.3	339	75.3	253	56.2	349	77.6
<b>935HO</b>	3500K	High	8.6	592	68.8	704	81.9	559	65.0	625	72.7	467	54.3	645	75.0
<b>940</b>	4000K	Standard	4.5	326	72.4	386	85.8	306	68.0	342	76.0	256	56.9	354	78.7
<b>940HO</b>	4000K	High	8.6	598	69.5	711	82.7	565	65.7	632	73.5	472	54.9	653	75.9

Direct Source: MOD Options

- Specify **MOD** in the part number for any of the below options
- All RGB\_ Source Options will require specific driver and control
- Consult factory for **MOD** specification details, pricing, and lead-time information

**MOD** TIR Optics

Specifications and dimensions subject to change without notice. Specification sheets that appear on pinnacle-ltg.com are the most recent version and supersede all other previously printed or electronic versions.



## Length

- All individual units cannot be joined, end trims are factory installed and cannot be removed
- Continuous Rows are made up of even and odd length fixtures; designed to fall on-grid
- Choose fixture length for Individual or Continuous Row length; for patterns refer to Pattern section on page 6

2	3	4	5	6	7	8	–
Indiv. Fixture	Indiv. Fixture	Indiv. Fixture	Indiv. Fixture	Indiv. Fixture	Indiv. Fixture	Indiv. Fixture	Cont. Run
23" (584.2mm)	35" (889mm)	47" (1193.8mm)	59" (1498.6mm)	71" (1803.4mm)	83" (2108.2mm)	95" (2413mm)	Specify nominal overall row length to the 1/8"

Specify to the 1/8"

## Pattern

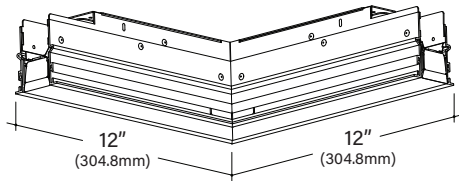

- Specify pattern shape and overall dimensions (includes corner dimensions)
- 90 degree corners are 12"x12" (overall, outside dimension)
- Angles and shapes not shown require Mod Pattern; consult factory
- Only available with HE lens option

S	R x	U x x	L x	T x	X x	WC x
Square	Rectangle	U-Shape	L-Shape	T-Shape	X-Shape	Wall to Ceiling
Provide A dimension	Provide Ax B dimensions	Provide Ax BxC dimensions	Provide Ax B dimensions	Provide Ax B dimensions	Provide Ax B dimensions	Provide WxC dimensions
Example: <b>S4'</b>	Example: <b>R4'x4'</b>	Example: <b>U3'x4'x3'</b>	Example: <b>L3'x3'</b>	Example: <b>T3'x5'</b>	Example: <b>X5'x5'</b>	Example: <b>WC2'x2'</b>
Nominal Length- 4'x4'	Nominal Length- 4'x4'	Nominal Length- 3'x4'x3'	Nominal Length- 3'x3'	Nominal Length- 3'x5'	Nominal Length- 5'x5'	Nominal Length- 2'x2'
Minimum Length- 3'11"x3'11"	Minimum Length- 3'11"x3'11"	Minimum Length- 2'11"x3'11"x2'11"	Minimum Length- 2'11"x2'11"	Minimum Length- 2'11"x4'10"	Minimum Length- 4'10"x4'10"	Minimum Length- 1'11"x1'11"

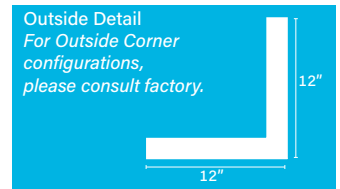
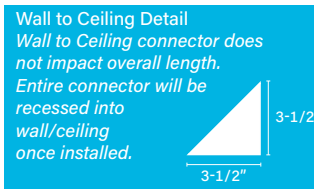
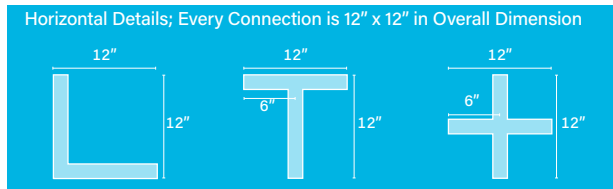
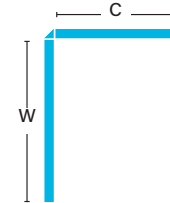
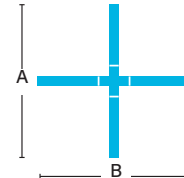
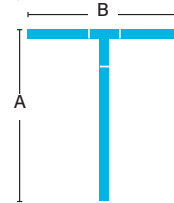
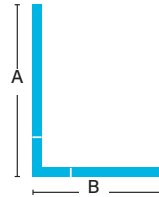
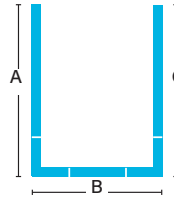
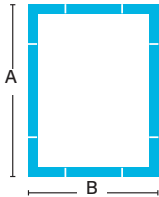
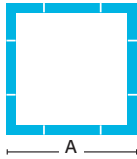

## Length or Pattern: MOD Options

- Specify **MOD** in the part number for any of the below options
- Consult factory for **MOD** specification details, pricing, and lead-time information
- Perimeter mount mod will be mounted on wall surface with room side of fixture being taller than wall side

<b>MOD</b>	Specify MOD for patterns, lengths or angles not shown above
	45- 180 degree angles
	Single-piece welded housings up to 4' x 4'



## Mounting

- Individual units cannot be joined, end trims are factory installed and cannot be removed
- Designed to install into acoustical grid and inaccessible ceilings
- Grid retention brackets integral to housing and require mechanical attachment to grid
- Each housing contains 4 grid retention brackets
- Tie off fixture to structure with retention wires
- Approved for dry/damp location unless otherwise noted

G1	G9	GB	GS	FL	NF	SF
1" (15/16") T-Bar Flange to Flange: 2-5/16" (58.7mm)	9/16" T-Bar For tegular tile installations, fixture position will not be flush to the bottom of the tile Flange to Flange: 2-5/16" (58.7mm)	9/16" T-Bar Rail has bevel edge tile details. For tegular tile installations, fixture position will be flush to the bottom of the tile Flange to Flange: 2-5/16" (58.7mm)	Screw Slot & 9/16" T-Bar For 9/16" installations with tegular tile, fixture position will be flush to the bottom of the tile Flange to Flange: 2-5/16" (58.7mm)	Exposed Standard 1/2" Flange Detail Flange to Flange: 2-5/8" (66.7mm)	Metal Pan or Millwork Flange to Flange: 2" (50.1mm)	Drywall, Flangeless Detail Flange to Flange: 3-1/2" (88.9mm)
 Standard Tile	 Standard Tile	 Tegular Tile	 Tegular Tile	 Standard Tile	 Metal Pan or Millwork	 Drywall
 Tegular Tile	 Tegular Tile		 Tegular Tile		 Metal Pan or Millwork	 Drywall
					<b>PM</b> Optional Perimeter Mounting Includes bracket and wall rail 	

## Mounting: MOD Options

- Specify **MOD** in the part number for any of the below options
- Consult factory for **MOD** specification details, pricing, and lead-time information

<b>MOD</b>	Recessed to Suspended
	Alternative Ceiling Solutions
	Combination Rails
	Perimeter mount with 2" Drop
	Perimeter mount with 3" Drop
	Perimeter mount with 4" Drop

## Voltage

- Some EV1 configurations will not accommodate all voltage options; consult with factory

<b>U</b>	Universal
<b>1</b>	120 volt
<b>2</b>	277 volt
<b>3</b>	347 volt



## Driver

- Standard Driver Option = FSD
- Driver Lifetime: 50,000 hours at 25°C ambient operating conditions
- For more driver options see Pinnacle Resource Guide
- Some EV1 configurations will not accommodate all driver options; consult with factory

### 0-10V Drivers

<b>FSD</b>	Factory Select Driver 1%, 0-10v
<b>PL2</b>	Signify Advance Xitanium 1%, 0-10v
<b>PL4</b>	Advance Xitanium 347v 1%, 0-10v, requires 347v
<b>OL2</b>	Osram Optotronic, 1%, 0-10v
<b>OL4</b>	Osram Optotronic 347v, 1% 0-10v, requires 347v option
<b>EE1</b>	eldoLED ECOdrive 1%, 0-10v Logarithmic
<b>EE2</b>	eldoLED ECOdrive 1%, 0-10v Linear
<b>ES1</b>	eldoLED SOLOdrive 0-10v, 0.1% Logarithmic
<b>ES2</b>	eldoLED SOLOdrive 0-10v, 0% Linear

### DALI Drivers

<b>EE3</b>	eldoLED ECOdrive .1%, DALI (logarithmic)
<b>ES3</b>	eldoLED SOLOdrive .1%, DALI (logarithmic)
<b>OD1</b>	Osram Optotronic 1%, DEXAL
<b>OD2</b>	Osram Optotronic 1%, DALI 2 Channel

### Lutron Drivers

<b>LH1</b>	Lutron Hi-lume Soft-on, Fade-to-black 1%, EcoSystem, LDE1
<b>LH4</b>	Lutron Hi-Lume 1%, 2-wire, Lutron-LTEA2W, 120v only

### Alternate Drivers

<b>PS1</b>	Signify Advance Xitanium Step Dimming 50%/100%
<b>EH1</b>	ELV 120v only, 0-10v universal

## Driver: MOD Options

- Specify **MOD** in the part number for any of the below options
- Consult factory for **MOD** specification details, pricing, and lead-time information

**MOD** Power Over Ethernet

## How to specify Circuiting, Battery and Emergency

- Select fixture circuiting from options below
  - Some EV1 configurations will not accommodate all circuiting options, consult with factory

### Circuiting

<b>1</b>	Single Circuit
<b>M</b>	Multi Circuit
<b>E</b>	Emergency Circuit only
<b>N</b>	Night Light Circuit only

- Battery and emergency section options are available in addition to fixture circuit
  - Select battery and emergency section options below; factory shop drawing required
  - Some EV1 configurations will not accommodate all circuiting options, consult with factory

### Battery and/or Emergency If Required

**0** No battery or specific emergency section required



## Battery

- Select battery section type if required, indicate total QTY. *Example 2PL*
- 90 minute battery runtime; test button is remote to fixture
- Battery not available for lengths under 4'

- Entire fixture is on battery for lengths up to 5'
- Half of fixture is on battery for 6', 7' or 8' housing lengths
- For more battery options available, see Pinnacle Resource Guide

<b>0</b>	No Battery
<b>_FSB</b>	Factory Select Battery (10w option)
<b>_FSBST</b>	Factory Select Battery (10w, Self Testing)
<b>_ILL</b>	Iota 10w Integral Lithium, Self Testing
<b>_IRH</b>	Iota 20w Remote
<b>_PRH</b>	Bodine 20w Remote
<b>_PLL</b>	Bodine 10w Integral Lithium, Self Testing

### For Approximate Battery Lumen Output

- Multiply battery wattage X fixture LPW shown on Lumen Table
- 92.3 (LPW) x 10 (watts) = 923 battery lumen output

## Emergency

- Select emergency section type if required, indicate total QTY. *Example 1E*
- Combine battery and emergency section ordering codes if both options are selected

<b>_FSG</b>	Factory Select Automatic Load Control Relay (ALCR), UNV
<b>_GI</b>	Emergency Transfer Switch (ETS) DR Emergency Control Device, UNV
<b>_GB</b>	Bodine GTD, Generator Transfer Device, 120v or 277v
<b>_E</b>	Emergency circuit section
<b>_N</b>	Night Light circuit section
<b>_L</b>	Life Safety circuit section NO THROUGH WIRE

### Battery OR Emergency Ordering Examples

- Single circuit, 10w Integral Battery      Ordering Code: 1-1PL
- Emergency only, 10w Integral Battery      Ordering Code: E-1PL
- Single circuit, GTD required              Ordering Code: 1-1G

### Combination Section Ordering Examples

- Single circuit, (1) 10w battery, (1) emergency section      Ordering Code: 1-1PL1E
- Multi circuit, (2) 10w battery, (2) emergency sections      Ordering Code: M-2PL2E
- Single circuit, (1) night light section              Ordering Code: 1-1N

## Finish

- Standard powder-coat textured white, metallic silver, textured black, graphite or bronze painted finish; consult factory for chip of standard paint finishes
- Selecting a fixture finish other than white may impact lumen output; consult factory for more information

<b>W</b>	White
<b>S</b>	Metallic Silver
<b>BL</b>	Textured Black
<b>GR</b>	Graphite
<b>BR</b>	Bronze
<b>CC</b>	Custom Color

## Fixture Options

- Additional options to enhance the fixture and finish of the product

<b>FIL</b>	Field Cut Illuminated Extension
<b>CP</b>	Chicago Plenum
<b>PM</b>	Perimeter Mount
<b>RC</b>	Rotating Crossbar
<b>DSP</b>	Customer Supplied Battery/Driver/Sensor
<b>GLR</b>	Internal Fast Blow Fuse
<b>FW6</b>	6' Flex Whip

## Controls

- Pinnacle is able to accommodate different control solutions from different manufacturers. Consult Factory for more information



**Photometrics**

**High Efficiency Lens**

Test #	ITL86985
Catalog #	EV1HE-840-4
Lumens	1726 Lm
Watts	19.9 W
Efficacy	87 LPW

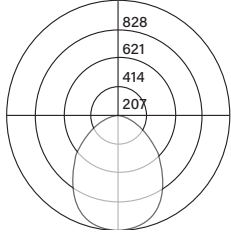

**Candela Distribution**

Vert Angle	Horizontal Angle				
	0	22.5	45	67.5	90
0	828	828	828	828	828
5	823	824	823	822	821
10	810	808	804	799	796
15	787	779	769	757	751
20	753	739	722	699	690
25	710	689	662	629	614
30	657	632	595	554	537
35	596	569	524	477	459
40	528	499	449	404	387
45	457	429	379	336	323
50	385	361	315	277	266
55	317	296	256	225	216
60	253	234	203	179	172
65	194	180	156	140	135
70	142	132	116	103	100
75	97	90	79	72	70
80	58	54	48	44	44
85	26	24	21	20	20
90	0	0	0	0	0

**Luminance Data (cd/sq.m)**

Angle In Degrees	Average 0-Deg	Average 45-Deg	Average 90-Deg
45	14181	11775	10034
55	12136	9795	8273
65	10063	8103	6991
75	8216	6745	5967
85	6677	5393	5136

**Batwing Lens**

Test #	ITL86987
Catalog #	EV1BW-840-4
Lumens	1371 Lm
Watts	19.9 W
Efficacy	69 LPW

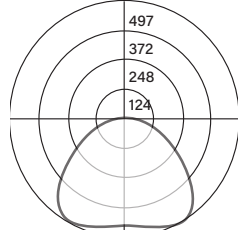

**Candela Distribution**

Vert Angle	Horizontal Angle				
	0	22.5	45	67.5	90
0	445	445	445	445	445
5	443	447	451	452	453
10	436	443	450	456	459
15	424	432	447	463	470
20	408	417	443	471	483
25	387	397	436	477	494
30	362	374	422	474	497
35	334	348	400	459	484
40	303	317	371	431	454
45	270	284	335	388	409
50	236	248	293	337	352
55	202	210	248	282	293
60	168	174	203	228	236
65	135	138	159	176	182
70	103	104	118	129	133
75	73	73	81	87	89
80	46	45	49	51	52
85	22	20	21	21	21
90	0	0	0	0	0

**Luminance Data (cd/sq.m)**

Angle In Degrees	Average 0-Deg	Average 45-Deg	Average 90-Deg
45	8386	10419	12705
55	7728	9489	11229
65	7030	8267	9448
75	6198	6887	7576
85	5454	5317	5317

**Asymmetric Lens**

Test #	ITL86988
Catalog #	EV1WHE-840-4
Lumens	1532 Lm
Watts	19.9 W
Efficacy	77 LPW

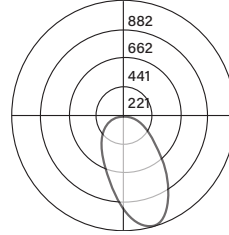

**Candela Distribution**

Vert Angle	Horizontal Angle				
Angle	0	22.5	45	67.5	90
0	715	715	715	715	715
5	803	777	711	651	626
10	862	819	696	580	538
15	879	839	672	513	463
20	848	830	637	451	402
25	769	790	593	398	353
30	664	724	543	351	314
35	554	641	487	309	283
40	450	548	428	271	254
45	361	457	367	236	229
50	289	373	310	203	201
55	230	297	255	172	174
60	181	231	204	142	145
65	140	175	158	113	116
70	103	126	117	85	88
75	71	85	81	60	62
80	44	51	49	37	38
85	20	23	23	17	16
90	0	0	0	0	0

**Luminance Data (cd/sq.m)**

Angle In Degrees	Average 0-Deg	Average 45-Deg	Average 90-Deg
45	11226	14201	11411
55	8805	11374	9779
65	7254	9110	8210
75	6061	7208	6841
85	5045	5726	5726

For all available IES files, please visit our website at [pinnacle-ltg.com](http://pinnacle-ltg.com). Photometry testing in accordance to IESNA-LM-79-08 at an NVLAP accredited testing laboratory. Testing conducted at 25°C ambient conditions



## Applications & Certificates

**Construction:** Formed cold-rolled 20 gauge steel housing. Highly reflective die-formed white painted aluminum reflector.

**Shielding:** Diffuse snap-in acrylic lens, removable for maintenance.

**Mounting:** EDGE is designed to install into acoustical grid and inaccessible ceilings. Specify GXG, FLF, SFS, NFN for individual, unjoinable units (individual units will fall on-grid). Specify GX, FL, SF, NF for continuous runs (runs designed to fall on-grid). Consult factory for detailed installation instructions. Maximum fixture weight is 15lbs per 4' fixture.

**LED:** 25°C test environment. Lumen output/wattage has a margin of +/- 5%; 2' or 3' lengths may have a greater wattage deviation. Luminaire configurations tested in accordance with IES LM-79. Diodes tested in accordance with IES LM-80. Lifetime calculated using IES TM-21. Minimum lifetime greater than 60,000 hours. Lifetime Projection L70 = 117,400 hours and L90 = 35,000 hours. MacAdam 3-Step Ellipses. Not all products are Lighting Facts listed. For all available IES files, please visit our website at [pinnacle-ltg.com](http://pinnacle-ltg.com).

**CRI, CCT & Lumen Output:** Two lumen packages available. Standard and High (HO). Custom outputs are available. Specify custom lumens or watts between standard offering listed on CRI, CCT & Output page. 80 CRI is available for 3000K, 3500K, and 4000K. 90 CRI is available for 2700K, 3000K, 3500K, and 4000K. 90 CRI = R9≥50.

**Voltage:** Universal (U), 120 volt (1), 277 volt (2) and 347 volt (3) options available. Must specify OL4 in Driver section when 347 volt (3) is selected. Some EDGE configurations will not accommodate all voltage options; consult with factory.

**Driver:** Standard Driver Option is Advance Xitanium 0-10V, 1% = PL2. Electronic driver, Power factor is >0.9 with a THD <20%. Driver Lifetime: 50,000 hours at 25°C ambient operating conditions. Ambient operating range: -20°F/-30°C to 92°F/33°C. For more driver options, see Pinnacle Resource Guide. Some EDGE configurations will not accommodate

all driver options.

**Circuiting:** Select from single circuit (1), Multi circuit - For multiple circuiting and zone control, requires factory shop drawing (M), Emergency circuit (E), Life Safety (L) or Night Light circuit (N). For emergency circuiting situations that require no through wire or circuit separation, Life Safety Circuit should be selected. This will provide a separate power feed and only the Life Safety Circuit in that section. Some EDGE configurations will not accommodate all circuiting options; consult with factory.

**Battery & Emergency:** Select battery or emergency options if required. If battery or emergency option is not required, enter 0. Battery duration is 90 minutes as standard. Test button is remote to fixture. For more Battery options, see Pinnacle Resource Guide.

**Finish:** Standard powder-coat textured white, metallic silver, textured black, graphite or bronze painted finish; consult factory for chip of standard paint finishes or for additional custom color and finish options.

**Controls:** Specify PD for daylight sensor, requires 0-10v driver. Some EDGE configurations will not accommodate all control options; consult with factory.

**Labels:** UL and cUL 1598 listed. Standard and HO lumen packages are IC Rated, approved for dry/damp location unless otherwise noted.

**Fixture Weight:** Maximum fixture weight is 15lbs per 4' fixture.

**Buy American Act Compliant**

**Warranty:** EDGE LED offered with a 5-year limited warranty. Covers LED, driver and fixture.