

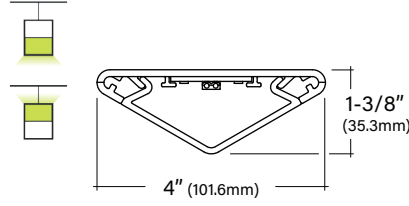

FACTORY DRAWING AND SIGN OFF REQUIRED WITH THIS PRODUCT.



# VERBENA V4AJ

4" Direct and Indirect Linear with Alternating Joint



Indirect Orientation

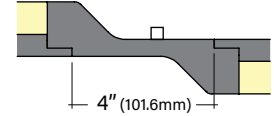

## Specification Features

- Triangular lens form factor with 145LPW direct or 165LPW indirect widespread illumination
- Enhanced lighting pattern with 6% contribution past nadir
- Minimalistic profile with overall height less than 1 1/2" with triangular lens
- Integral suspension and power cable with singular adjustment mechanism
- Triangular lens form factor with up to 2000lm/ft or 2300lm/ft indirect widespread illumination
- Milled X, T, Y, 90°, 120°, 135° connectors, and a direct-to-indirect alternating joint



Example Part #: V4AJ-A-830HO-26'-CAC48JB-U-FSD-1-0-W



<b>V4AJ</b>			
<b>HOUSING</b>	<b>SHIELDING</b>	<b>CRI, CCT &amp; OUTPUT<sup>1</sup></b>	<b>LENGTH OR PATTERN<sup>2</sup></b>
<b>V4AJ</b> - Verbena 4 Alternating Joint <i>Housing pg. 2</i>  For straight runs, specify overall nominal length. Use page 7 to draw out the straight run and include all alternating joints while indicating light directionality and shielding.	<b>A</b> - Satine Lens <b>WS</b> - Widespread Lens <i>Shielding pg. 2</i>	_27_ - 2700K _30_ - 3000K _35_ - 3500K _40_ - 4000K <b>CL</b> - Custom Lumens <b>CW</b> - Custom Watts <i>Lumen Output pg. 2</i>	_ - Individual Fixture _ - Continuous Row <b>S</b> - Square <b>H</b> - Hexagon <b>O</b> - Octagon <b>R_x_x</b> - Rectangle <b>L_x_x</b> - L-Shape <b>U_x_x_x</b> - U-Shape <b>Y_x_x_x</b> - Y-Shape <b>T_x_x_x</b> - T-Shape <b>X_x_x_x_x</b> - X-Shape <i>Length and Pattern pg. 2-3</i>
<b>MOUNTING<sup>3</sup></b>	<b>VOLTAGE</b>	<b>REMOTE DRIVER</b>	<b>CIRCUITING</b>
<b>CAC_x_G</b> - Conductive AC to Grid <b>CAC_x_JB</b> - Conductive AC to J Box <i>Mounting pg. 3</i>	<b>U</b> - Universal (120 thru 277V) <b>1</b> - 120V <b>2</b> - 277V <b>3</b> - 347V <i>Voltage pg. 4</i>	<b>FSD</b> - Factory Select Driver (1%, 0-10v) <b>PL2</b> - Advance Xitanium (1%, 0-10v) <b>OL4</b> - Osram 347v (1%, 0-10v) <b>EE1</b> - eldoLED Ecodrive (1%, 0-10v) <b>ES1</b> - eldoLED SOLOdrive (0.1%, 0-10v) <b>LH1</b> - Lutron Hi-lume (1%, EcoSystem) <b>OL2</b> - Osram (1%, 0-10v) <i>Driver pg. 4</i>	<b>1</b> - Single Circuit <b>E</b> - Emergency (entire fixture) <b>N</b> - Night Light (entire fixture) <i>Circuiting pg. 4</i>
<b>BATTERY &amp; EMERGENCY<sup>4</sup></b>	<b>FINISH</b>	<b>CONTROLS</b>	
<b>0</b> - None <b>_FSG</b> - Factory Select ALCR <b>_FSB</b> - Factory Select Battery <b>_GI</b> - Iota ETS DR <b>_GB</b> - Bodine GTD <b>_PLL</b> - Bodine 10W (remote) <b>_ILL</b> - Iota 10W (remote) <b>_E</b> - Emergency Section <b>_N</b> - Night Light Section <i>Battery and Emergency pg. 5</i>	<b>W</b> - White <b>S</b> - Metallic Silver <b>BL</b> - Textured Black <b>BR</b> - Bronze <b>GR</b> - Graphite <b>CC</b> - Custom Color <i>Finish pg. 5</i>	Pinnacle is able to accommodate different control solutions from different manufacturers. Consult Factory for more information.	

<sup>1</sup>When specifying CRI, CCT & OUTPUT the first \_ is for specifying either 8 - 80CRI or 9 - 90CRI. The ending \_\_ are for specifying output, example **HO** - High Output. See output charts for more information. <sup>2</sup>Continuous row comes in 1' increments starting at 2'. For straight runs specify overall nominal length and use last page to draw out how the length should be broken down into directions. For patterns specified length will be fixture length. Patterns will be longer than specified length. For Mod layouts consult factory. <sup>3</sup>Specify CAC length standard CAC is 48". Specify grid: G1=15/16", G9=9/16", GS=Screw Slot. Example: CAC48G1 <sup>4</sup>Enter quantity for Battery and Emergency, Example 1PLL.

Specifications and dimensions subject to change without notice. Specification sheets that appear on pinnacle-ltg.com are the most recent version and supersede all other previously printed or electronic versions.



Shielding

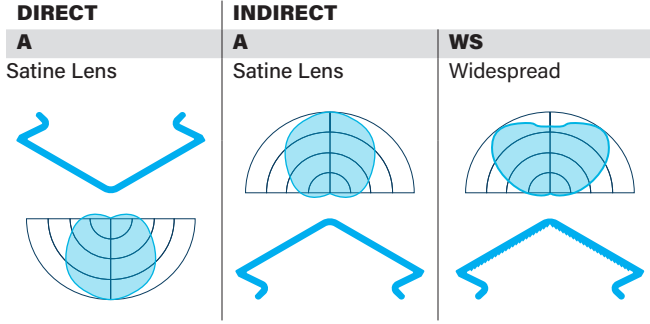

Output

- Specify either 80 or 90 CRI
- Longer lead-time may apply for 90 CRI. Consult factory.
- 90 CRI = R9≥50

Custom Output - Lumens OR Wattage

CL _____	Specify CRI, CCT and desired lumens (i.e. CL835500)	Total Max lumens: A Lens- 2,012, WS Lens- 2,330. Max lumens dependant on color temp. Consult factory for more information
CW _____	Specify CRI, CCT and desired wattage (i.e. CW9407)	Total Max watts: 14.8. Consult factory for more information

80 CRI

	Color	Output	Lumens per foot	Shielding			
				A Satine Lens		WS Widespread	
				LPW	Watts/ft	LPW	Watts/ft
<b>830LO</b>	3000K	Low	500	142	3.5	162	3.1
<b>830MO</b>	3000K	Medium	750	141	5.3	161	4.7
<b>830HO</b>	3000K	High	1000	141	7.1	159	6.3
<b>835LO</b>	3500K	Low	500	146	3.4	166	3.0
<b>835MO</b>	3500K	Medium	750	145	5.2	165	4.5
<b>835HO</b>	3500K	High	1000	145	6.9	164	6.1
<b>840LO</b>	4000K	Low	500	148	3.4	168	3.0
<b>840MO</b>	4000K	Medium	750	147	5.1	168	4.5
<b>840HO</b>	4000K	High	1000	146	6.9	167	6.0

90 CRI

<b>927LO</b>	2700K	Low	500	114	4.4	132	3.8
<b>927MO</b>	2700K	Medium	750	112	6.7	131	5.7
<b>927HO</b>	2700K	High	1000	111	9.0	131	7.7
<b>930LO</b>	3000K	Low	500	117	4.3	137	3.7
<b>930MO</b>	3000K	Medium	750	116	6.5	135	5.5
<b>930HO</b>	3000K	High	1000	115	8.7	135	7.4
<b>935LO</b>	3500K	Low	500	119	4.2	139	3.6
<b>935MO</b>	3500K	Medium	750	118	6.4	137	5.5
<b>935HO</b>	3500K	High	1000	117	8.5	137	7.3
<b>940LO</b>	4000K	Low	500	123	4.1	143	3.5
<b>940MO</b>	4000K	Medium	750	121	6.2	141	5.3
<b>940HO</b>	4000K	High	1000	120	8.3	141	7.1

Length

- All individual units cannot be joined, end plates are factory installed and cannot be removed
- End caps add 2-1/2" (1-1/4" per end) to the overall length of the fixture/row, end caps do not add to the mounting distance
- For patterns, refer to Pattern section on next page

1	2	3	4	5	6	7	8	-
Indiv. Fixture	Indiv. Fixture	Indiv. Fixture	Indiv. Fixture	Indiv. Fixture	Indiv. Fixture	Indiv. Fixture	Indiv. Fixture	Cont. Run Specify nominal overall row length to the 1'
12" (304.8mm)								
	24" (609.6mm)							
		36" (914.4mm)						
			48" (1219.2mm)					
				60" (1524mm)				
					72" (1828.8mm)			
						84" (2133.6mm)		
							96" (2438.4mm)	

Specify to the 1' >>>>

Specifications and dimensions subject to change without notice. Specification sheets that appear on pinnacle-ltg.com are the most recent version and supersede all other previously printed or electronic versions.

Designed in Denver, CO • USA | pinnacle-ltg.com | O: 303-322-5570 F: 303-322-5568

V4AJ\_LED\_SPEC\_JAN2023



## Patterns

- If using alternating joint with patterns use last page to draw out the pattern
- Direction of light must be the same on all sides of a connector, can only change direction of light in straight section
- Specify pattern shape and requested fixture length
- Length specified will not reflect overall pattern dimensions
- Angles and shapes not shown require Mod Pattern; consult factory
- All connectors are NON ILLUMINATED
- Driver/Battery Count dictated by product configuration
- Minimum length for any single part of a pattern is 2'
- All lengths are TO THE FOOT ONLY

S_	H_	O_	R_x_	U_x_x_	L_x_	Y_x_x_	T_x_x_	X_x_x_x_	MOD
<b>Square</b> Provide A dimension Example: <b>S12'</b>	<b>Hexagon</b> Provide A dimension Example: <b>H12'</b>	<b>Octagon</b> Provide A dimension Example: <b>O12'</b>	<b>Rectangle</b> Provide Ax B dimensions Example: <b>R16'x12'</b>	<b>U-Shape</b> Provide Ax BxC dimensions Example: <b>U12'x16'x12'</b>	<b>L-Shape</b> Provide Ax B dimensions Example: <b>L12'x12'</b>	<b>Y-Shape</b> Provide Ax BxC dimensions Example: <b>Y12'x16'x12'</b>	<b>T-Shape</b> Provide Ax BxC dimensions Example: <b>T12'x12'x12'</b>	<b>X-Shape</b> Provide Ax BxCxD dimensions Example: <b>X12'x16'x12'x16'</b>	<b>Multi Connector Layout</b> For patterns other than shown, factory drawing and sign off required with all MODS

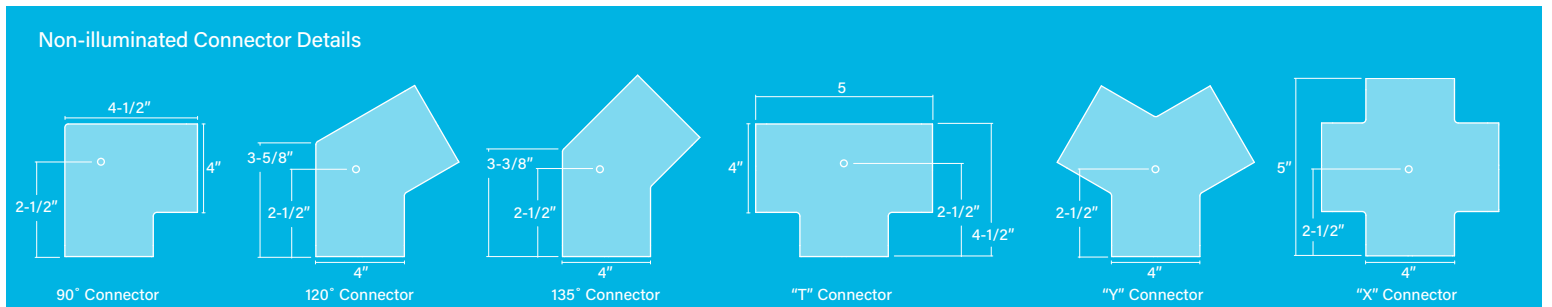

## Mounting

- Driver/Battery Count dictated by product configuration
- Specify cable length in ordering code (CAC48JB)
- Standard adjustable cable. Specify 48", 120", 240", or 350"
- End plates attached at factory
- Canopies and mounts match fixture finish. See Finish section for additional details.
- Approved for dry/damp location unless otherwise noted
- Refer to installation instructions during installation at the job site
- Maximum fixture weight is 10 lbs for a standard 4' fixture

**CAC\_\_G\_** Conductive AC to Grid (specify grid type: G1, G9, GS)  
**CAC\_\_JB** Conductive AC to Junction Box

### CAC Canopy Details

- CAC is an integrated power and suspension cable that is smaller in diameter than a traditional SJT cable. CAC is 2 conductive cables and suspension, standard power cable (SJT) is 5 conductive cables and no suspension.

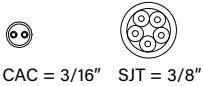

- A larger power side canopy allows for adjustability of the CAC cable inside of the canopy.

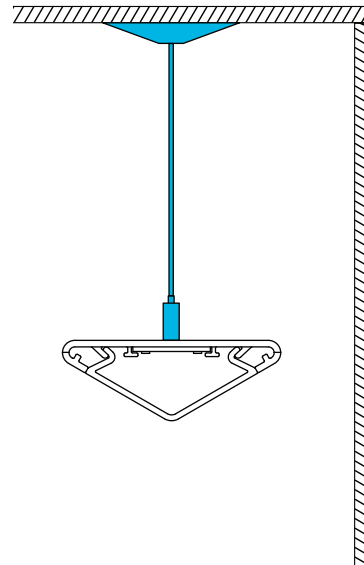
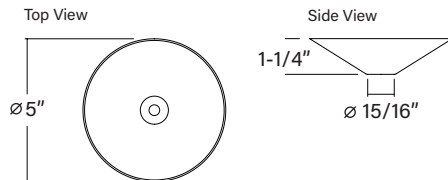

Specifications and dimensions subject to change without notice. Specification sheets that appear on pinnacle-ltg.com are the most recent version and supersede all other previously printed or electronic versions.



## Voltage

- Some VERBENA configurations will not accommodate all voltage options; consult with factory

<b>U</b>	Universal
<b>1</b>	120 volt
<b>2</b>	277 volt
<b>3</b>	347 volt

## Remote Driver

- Driver/Battery Count dictated by product configuration
- Standard Driver Option = FSD
- Driver Lifetime: 50,000 hours at 25°C ambient operating conditions
- For more driver options, see Pinnacle Resource Guide
- Some VERBENA configurations will not accommodate all driver options; consult with factory
- All configurations with no PLL, ILL or Emergency Control Device options will use Slim Remote Box

Slim Remote Box

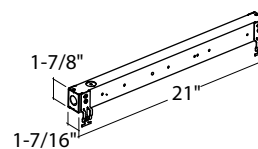

### 0-10V Drivers

<b>FSD</b>	Factory Select Driver (1%, 0-10v)
<b>PL2</b>	Signify Advance Xitanium 1%, 0-10v
<b>OL2</b>	Osram Optotronic, 1%, 0-10v
<b>OL4</b>	Osram Optotronic 347v, 1% 0-10v, requires 347v option
<b>EE1</b>	eldoLED ECOdrive 1%, 0-10v Logarithmic
<b>EE2</b>	eldoLED ECOdrive 1%, 0-10v Linear
<b>ES1</b>	eldoLED SOLOdrive 0-10v, 0.1% Logarithmic
<b>ES2</b>	eldoLED SOLOdrive 0-10v, 0% Linear

### DALI Drivers

<b>EE3</b>	eldoLED ECOdrive .1%, DALI (logarithmic)
<b>ES3</b>	eldoLED SOLOdrive .1%, DALI (logarithmic)

### Lutron Drivers

<b>LH1</b>	Lutron Hi-lume Soft-on, Fade-to-black 1%, EcoSystem, LDE1
<b>LH4</b>	Lutron Hi-Lume 1%, 2-wire, Lutron-LTEA2W, 120v only

## How to specify Circuiting, Battery and Emergency

- Select fixture circuiting from options below
  - Some VERBENA configurations will not accommodate all circuiting options, consult with factory

## Circuiting

<b>1</b>	Single Circuit
<b>2</b>	Dual Circuit
<b>E</b>	Emergency Circuit only
<b>N</b>	Night Light Circuit only



- Battery and emergency section options are available in addition to fixture circuit
- Select battery and emergency section options below; factory shop drawing required
- Some VERBENA configurations will not accommodate all circuiting options, consult with factory
- Configurations with PLL or ILL or any Emergency control device will require standard remote box.

### Battery and/or Emergency *If Required*

**0** No battery or specific emergency section required

### Battery

- Select battery section type if required, indicate total QTY. *Example 2PLL*
- 90 minute battery runtime; test button is remote to fixture and requires an additional drop
- Entire direct fixture housing is on battery for individual fixtures
- For more battery options available, see Pinnacle Resource Guide

<b>0</b>	No Battery
<b>_FSB</b>	Factory Select Battery (10w option)
<b>_FSBST</b>	Factory Select Battery (Self Testing)
<b>_ILL</b>	lota 10w Integral Lithium, Self Testing
<b>_IRC</b>	lota 10w Remote
<b>_IRH</b>	lota 20w Remote
<b>_PLL</b>	Bodine 10w Integral Lithium, Self Testing
<b>_PRL</b>	Bodine 7w Remote
<b>_PRS</b>	Bodine 7w Remote, Self Testing
<b>_PRD</b>	Bodine 10w Remote, Dual Flex
<b>_PRH</b>	Bodine 20w Remote

Standard Remote Box

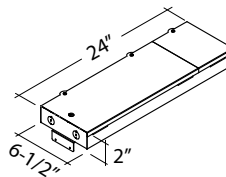

#### For Approximate Battery Lumen Output

- Multiply battery wattage X fixture LPW shown on Lumen Table
- 92.3 (LPW) x 10 (watts) = 923 battery lumen output

### Emergency

- Select emergency section type if required, indicate total QTY. *Example 1E*
- Combine battery and emergency section ordering codes if both options are selected
- Emergency circuiting sections are for use when specifying emergency options on continuous runs

<b>_FSG</b>	Factory Select Automatic Load Control Relay (ALCR), UNV
<b>_GI</b>	Emergency Transfer Switch (ETS) DR Emergency Control Device, UNV
<b>_GB</b>	Bodine GTD, Generator Transfer Device, 120v or 277v
<b>_E</b>	Emergency circuit
<b>_N</b>	Night Light circuit
<b>_L</b>	Life Safety circuit section NO THROUGH WIRE

#### Battery OR Emergency Ordering Examples

- Single circuit, 10w Battery Ordering Code: 1-1PLL
- Emergency only, 10w Battery Ordering Code: E-1PLL
- Single circuit, GTD required Ordering Code: 1-1GB

#### Combination Section Ordering Examples

- Single circuit, (1) 10w battery, (1) emergency section Ordering Code: 1-1PL1E
- Multi circuit, (2) 10w battery, (2) emergency sections Ordering Code: M-2PLL2E
- Single circuit, (1) night light section Ordering Code: 1-1N

### Finish

- Standard powder-coat textured white, metallic silver, textured black, graphite or bronze painted finish; consult factory for chip of standard paint finishes
- Selecting a fixture finish other than white may impact lumen output; consult factory for more information

<b>W</b>	White <i>(white cord/white canopy)</i>
<b>S</b>	Metallic Silver <i>(grey cord/silver canopy)</i>
<b>BL</b>	Textured Black <i>(black cord/black canopy)</i>
<b>BR</b>	Bronze <i>(white cord/bronze canopy)</i>
<b>GR</b>	Graphite <i>(white cord/graphite canopy)</i>
<b>CC</b>	Custom Color <i>(white cord/color match canopy)</i>

### Controls

- Pinnacle is able to accommodate different control solutions from different manufacturers. Consult Factory for more information.

Specifications and dimensions subject to change without notice. Specification sheets that appear on pinnacle-ltg.com are the most recent version and supersede all other previously printed or electronic versions.



## Photometrics

### Satine Lens

Test # KPL2015-4  
 Catalog # V4D-A-N-40-4  
 Lumens 3854 Lm  
 Watts 27.9 W  
 Efficacy 138 LPW

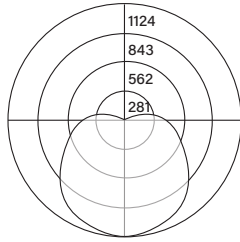

### Widespread Lens

Test # KPL2015-3  
 Catalog # V4I-N-WS-40-4  
 Lumens 3856 Lm  
 Watts 23.9 W  
 Efficacy 161 LPW

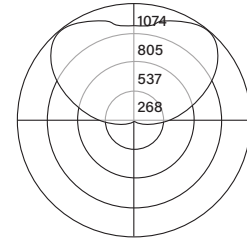

### Candela Distribution

Vert Angle	Horizontal Angle				
	0	22.5	45	67.5	90
0	1115	1115	1115	1115	1115
5	1108	1111	1110	1107	1108
10	1093	1095	1096	1094	1095
15	1069	1072	1073	1072	1073
20	1035	1038	1041	1042	1042
25	992	995	1000	1002	1003
30	941	945	953	956	957
35	883	886	895	901	902
40	817	820	831	842	843
45	743	747	763	775	777
50	666	671	689	705	708
55	581	589	613	634	638
60	492	503	535	565	570
65	402	410	459	521	527
70	307	336	408	478	485
75	216	254	362	433	440
80	133	196	313	386	393
85	68	148	264	335	342
90	14	104	213	283	290

### Luminance Data (cd/sq.m)

Angle In Degrees	Average 0-Deg	Average 45-Deg	Average 90-Deg
45	10392	8331	7968
55	9896	7475	7150
65	9110	6532	6835
75	7674	6250	6921
85	5963	6279	7174

### Candela Distribution

Vert Angle	Horizontal Angle				
	0	22.5	45	67.5	90
90	12	88	198	242	244
95	40	131	265	313	316
100	87	184	338	389	390
105	145	242	412	473	475
110	212	311	490	560	568
115	285	387	573	646	650
120	358	461	662	731	737
125	428	536	746	824	830
130	500	607	818	911	917
135	573	674	877	981	990
140	641	732	918	1029	1040
145	703	782	942	1051	1062
150	759	825	956	1048	1059
155	811	861	961	1033	1041
160	855	890	960	1011	1017
165	889	910	954	984	989
170	914	924	945	959	962
175	930	934	938	940	942
180	936	936	936	936	936

For all available IES files, please visit our website at [pinnacle-ltg.com](http://pinnacle-ltg.com). Photometry testing in accordance to IESNA-LM-79-08 at an NVLAP accredited testing laboratory. Testing conducted at 25°C ambient conditions



## Multi Connector Layout

- Use the below to sketch your desired pattern. Available fixture and connectors are listed in the legend. Label your pattern components according to legend to simplify specification.
- Label the linear sections with length, and light direction - Direct (**D**) or Indirect (**I**), and shielding - Satine (**A**) or Widespread (**WS**); example 4'D-A would be 4' Direct with Satine Lens.
- Cannot use connector with another connector.
- Fixtures available in 1', 2', 3', 4', 5', 6', 7', and 8' lengths. All lengths are TO THE FOOT ONLY.
- CAN BE DONE: Alternating inbetween connectors ie. connector-8D-4I-8D-connector
- CANNOT BE DONE: Alternating at connectors ie. connector-8D-connector-8I

**Joint**

4"

**Connectors**

**C90**  
90° Connector

**C120**  
120° Connector

**C135**  
135° Connector

**T**  
"T" Connector

**Y**  
"Y" Connector

**X**  
"X" Connector

**AJ**  
Alternating Joint

**Example Part Number using Alternating Joint:**  
V4AJ-A-830-12'-AC48JB-U-FSD-2-0-W

**How to draw it out:**

Specifications and dimensions subject to change without notice. Specification sheets that appear on pinnacle-ltg.com are the most recent version and supersede all other previously printed or electronic versions.



## Applications & Certificates

**Construction:** 6063-T6 Extruded aluminum housing. Highly reflective die-formed white painted reflector.

**Shielding:** Diffuse snap-in acrylic lens with matte finish, removable for maintenance.

**Mounting:** Conductive Aircraft cable, wall and surface mount available. Power mount supplied with conductive aircraft cable and oval 6-1/2" H x 4-1/4" W canopy. Non-power supplied with aircraft cable and 2" (50.8mm) canopy. Refer to installation instructions for appropriate ceiling detail. Canopies are painted white unless otherwise specified. Maximum fixture weight is 10 lbs for a standard 4' fixture.

**LED:** 25°C test environment. Lumen output/wattage has a margin of +/- 5%; 2' or 3' lengths may have a greater wattage deviation. Luminaire configurations tested in accordance with IES LM-79. Diodes tested in accordance with IES LM-80. Lifetime calculated using IES TM-21. Minimum lifetime greater than 60,000 hours. L70 = 124,900 hours and L90 = 37,200 hours. MacAdam 3-Step Ellipses. Not all products are Lighting Facts listed. For all available IES files, please visit our website at [pinnacle-ltg.com](http://pinnacle-ltg.com).

**CRI, CCT & Output:** Three lumen packages available. Low (LO), Medium (MO) and High (HO). Custom outputs are available. Specify custom lumens or watts between standard offering listed on CRI, CCT & Output page. 80 CRI is available for 3000K, 3500K, and 4000K. 90 CRI is available for 2700K, 3000K, 3500K, and 4000K. 90 CRI = R9≥50.

**Voltage:** Universal (U), 120 volt (1), 277 volt (2) and 347 volt (3) options available. Must specify OL4 in Driver section when 347 volt (3) is selected. Some VERBENA configurations will not accommodate all voltage options; consult with factory.

**Driver:** Standard Driver option is Factory Selected Driver 0-10V, 1% = FSD. Electronic driver, Power factor is >0.9 with a THD <20%. Driver Lifetime: 50,000 hours at 25°C ambient operating conditions. Ambient operating range: -20°F/-30°C to 107°F/42°C. For more driver options, see Pinnacle Resource Guide. Some VERBENA configurations will not accommodate all driver options.

### Remote Mounting Guide

Distance limited by max input watts shown.

Max Distance	56' (.53A)	42' (.7A)	28' (1.05A)	20' (1.5A)	12' (2A)
4' Housing	4.0w/ft	5.4w/ft	8.1w/ft	11.6w/ft	17.2w/ft
8' Housing	N/A	2.6w/ft	4.0w/ft	5.8w/ft	7.8w/ft

**Circuiting:** Select from single circuit (1), Emergency circuit (E) or Night Light circuit (N). For emergency circuiting situations that require no through wire or circuit separation, Life Safety Circuit should be selected. This will provide a separate power feed and only the Life Safety Circuit in that section. Some VERBENA configurations will not accommodate all circuiting options; consult with factory.

**Battery & Emergency:** Select battery or emergency options if required. If battery or emergency option is not required, enter 0. Battery duration is 90 minutes as standard. Test button is remote to fixture. For more Battery options, see Pinnacle Resource Guide.

**Finish:** Standard powder-coat textured white, metallic silver, textured black, graphite or bronze painted finish; consult factory for chip of standard paint finishes. Canopies painted white unless specified differently in the options section of the part number. Contact factory for additional custom color and finish options.

**Controls:** Consult factory.

**Labels:** UL and cUL Listed. Low, Medium and HO lumen packages are approved for dry/damp location unless otherwise noted.

**Fixture Weight:** Maximum fixture weight is 10 lbs for a standard 4' fixture.

**Buy American Act Compliant**

**Warranty:** VERBENA offered with a 5-year limited warranty. Covers LED, driver and fixture.