

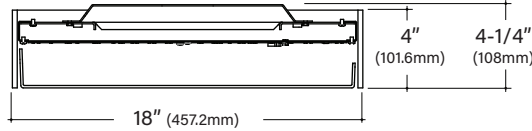

FINA F18D

18" Direct Suspended Architectural Round



Key Features

- Aluminum housing is rolled and welded for seamless finish with 1/4" trim
- Aluminum top cover conceals all electrical components. Highly reflective die-formed white painted steel reflector
- FINA offered with a 5-year limited warranty. Covers LED, driver and fixture
- ETL Listed conforming to UL1598 in US and CSA 250 in Canada
- Maximum fixture weight is 20 lbs
- Room-side maintenance for LED system
- Buy American Act compliant



Example Part #: F18D-A-830HO-AC348JB-U-PL2-1-0-W

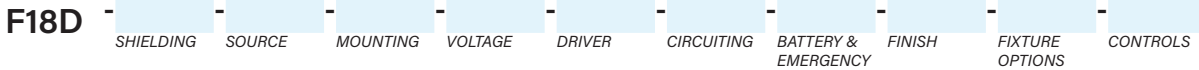

SHIELDING	SOURCE ¹	MOUNTING ²	VOLTAGE
A - Flush Satine Lens AR - Regress Satine Lens AL - Drop Satine Lens <i>Shielding pg. 2</i>	27 - 2700K 30 - 3000K 35 - 3500K 40 - 4000K CL - Custom Lumens CW - Custom Watts <i>Source pg. 2</i>	AC3 - 3 AC to JB or ST AH4 - 4 AC w/hub to JB or ST PP - Pendant Pipe to JB or ST PS - Pendant Swivel to JB or ST S - Surface Mount WA - Wall Mount <i>Mounting pg. 3</i>	U - Universal (120 thru 277V) 1 - 120V 2 - 277V 3 - 347V <i>Voltage pg. 3</i>
DRIVER	CIRCUITING	BATTERY & EMERGENCY	FINISH
FSD - Factory Select Driver (1%, 0-10v) PL2 - Advance Xitanium (1%, 0-10v) EE1 - eldoLED ECOdrive (1%, 0-10v) ES1 - eldoLED SOLOdrive (0.1%, 0-10v) LH1 - Lutron Hi-Lume (1%, EcoSystem) OL2 - Osram (1%, 0-10v) OL4 - Osram 347V (1%, 0-10v) <i>Driver pg. 3</i>	1 - Single Circuit E - Emergency (<i>entire fixture</i>) N - Night Light (<i>entire fixture</i>) <i>Circuiting pg. 4</i>	0 - None 1PB - Bodine 10W FSG - Factory Select ALCR GI - Iota ETS DR GB - Bodine GTD <i>Battery and Emergency pg. 4</i>	W - White S - Metallic Silver BL - Textured Black BR - Bronze GR - Graphite CC - Custom Color <i>Finish pg. 4</i>
FIXTURE OPTIONS	CONTROLS ³		
AM - Antimicrobial Paint DSP - Customer Supplied Battery/Driver/Sensor GMF - Slow Blow Fusing <i>Fixture Options pg. 4</i>	DLMFC - Wattstopper DLM (<i>wired</i>) ENLI - Enlighted (<i>wireless</i>) ENLC - Enlighted (<i>wireless</i>) <i>Controls pg. 4</i>		

¹When specifying SOURCE the first _ is for specifying either **8** - 80CRI, **9** - 90CRI. The ending _ _ are for specifying output, example **HO** - High Output. ²Example: AC348JB. AC3 = 3 Aircraft Cables, 48 = 48" long cables, JB = connects to junction box. Standard AC cable lengths are 48" and 120", field adjustable. Standard pendant lengths are 12", 18", or 24". ³Controls can only be used with Single Circuit (1) or Emergency Circuit (E), cannot be used with any battery options. See Controls chart on page 4 for driver options and more information.



Specifications and dimensions subject to change without notice. Specification sheets that appear on pinnacle-ltg.com are the most recent version and supersede all other previously printed or electronic versions.



Shielding

- White virgin acrylic lens with matte finish, removable for LED access
- Lens available in 3 positions

Ordering Code

A	AL	AR
Flush Satine Lens	Drop Satine Lens	Regress Satine Lens
		

Source: White LED

- Specify either 80 or 90 CRI
- Longer lead-time may apply for 90 CRI. Consult factory
- 90 CRI = R9≥50

Custom Output- Lumens OR Wattage

CL _____	Specify CRI, CCT and desired lumens (i.e. CL8352000)	<i>Specify lumens between standard offering listed below. Lumens are specified per color temp</i>
CW _____	Specify CRI, CCT and desired wattage (i.e. CW94020)	<i>Specify watts between standard offering listed below</i>

80 CRI

	Color	Shielding		
		A, AL, AR Satine Lens		
		Lumens	Watts	LPW
830LO	3000K	1262	12.1	104
830MO	3000K	2169	20.2	107
830HO	3000K	3039	28.2	108
835LO	3500K	1357	12.2	111
835MO	3500K	2335	20.4	115
835HO	3500K	3274	28.5	115
840LO	4000K	1355	12.2	111
840MO	4000K	2329	20.3	115
840HO	4000K	3262	28.4	115

90 CRI

927LO	2700K	1063	12.7	84
927MO	2700K	1802	21.3	84
927HO	2700K	2492	30.3	82
930LO	3000K	1106	12.5	88
930MO	3000K	1876	21.1	89
930HO	3000K	2594	29.8	87
935LO	3500K	1106	12.5	88
935MO	3500K	1876	21.1	89
935HO	3500K	2594	29.8	87
940LO	4000K	1160	12.6	92
940MO	4000K	1963	21.2	92
940HO	4000K	2708	30.1	90



Mounting

- Aircraft cables and pendants mount directly to a standard junction box or structure
- Canopies and pendants match fixture finish, power cords are white, grey, or black depending on fixture finish. See Finish section for additional details.
- Must specify overall pendant length of 12", 18" or 24"
- Must specify cable length, either 48" or 120" standard, field adjustable
- Tie off fixture to structure with retention wires
- Maximum fixture weight is 20 lbs

AC3__JB 3 AC cables to fixture to J-Box	AH4__JB 4 AC cables with hub to fixture to J-Box	PP__JB Pendant Pipe to J-Box	S Surface Mount Ceiling
AC3__ST 3 AC cables to fixture to Structure	AH4__ST 4 AC cables with hub to fixture to Structure	PS__JB Pendant Swivel to J-Box	WA Surface Mount Wall
		PP__ST Pendant Pipe to Structure	
		PS__ST Pendant Swivel to Structure	

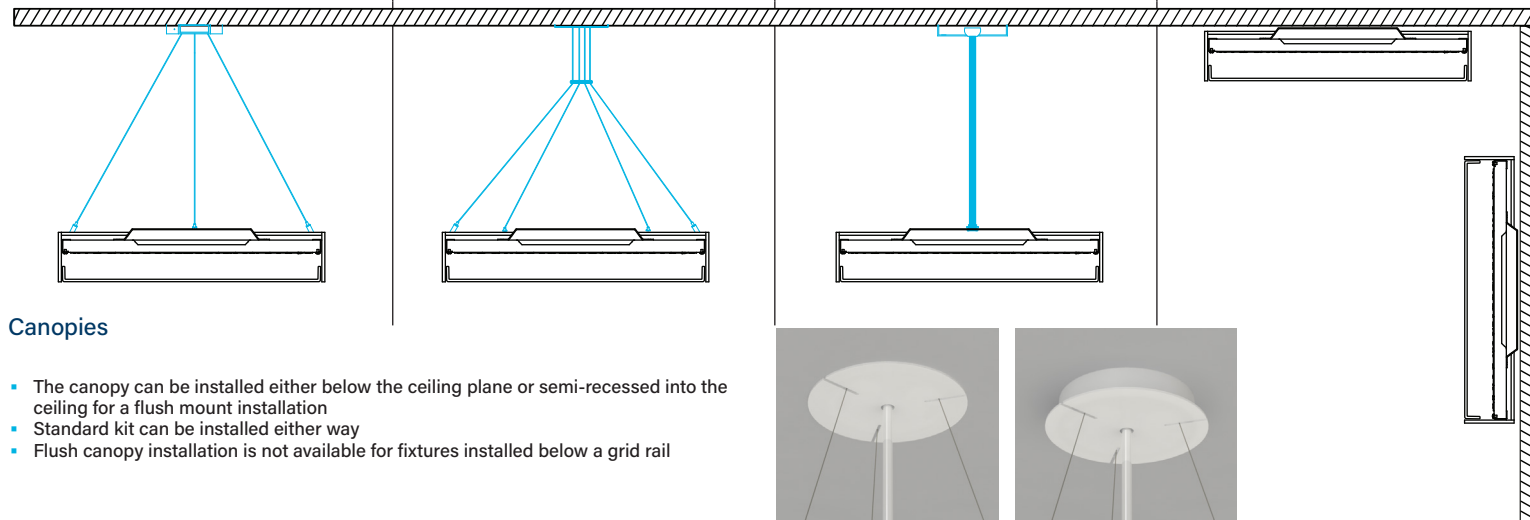

Canopies

- The canopy can be installed either below the ceiling plane or semi-recessed into the ceiling for a flush mount installation
- Standard kit can be installed either way
- Flush canopy installation is not available for fixtures installed below a grid rail

Voltage

- Some FINA configurations will not accommodate all voltage options; consult with factory

U	Universal
1	120 volt
2	277 volt
3	347 volt

Driver

- Standard Driver Option = FSD
- Driver Lifetime: 50,000 hours at 25°C ambient operating conditions
- For more Driver options, see Pinnacle Resource Guide on download pages at pinnacle-ltg.com
- Some FINA configurations will not accommodate all driver options; consult with factory

0-10V Drivers	
FSD	Factory Select Driver 1%, 0-10v
PL2	Advance Xitanium, 1%, 0-10v
OL2	Osram Optotronic, 1%, 0-10v
OL4	Osram Optotronic 347v, 1% 0-10v, requires 347v option
EE1	eldoLED ECOdrive 1%, 0-10v Logarithmic
EE2	eldoLED ECOdrive 1%, 0-10v Linear
ES1	eldoLED SOLOdrive 0-10v, 0.1% Logarithmic
ES2	eldoLED SOLOdrive 0-10v, 0% Linear
DALI Drivers	
EE3	eldoLED ECOdrive .1%, DALI (logarithmic)
ES3	eldoLED SOLOdrive .1%, DALI (logarithmic)
Lutron Drivers	
LH1	Lutron Hi-lume Soft-on, Fade-to-black 1%, EcoSystem, LDE1
LH4	Lutron Hi-Lume 1%, 2-wire, Lutron-LTEA2W, 120v only

Specifications and dimensions subject to change without notice. Specification sheets that appear on pinnacle-ltg.com are the most recent version and supersede all other previously printed or electronic versions.

Designed in Denver, CO • USA | pinnacle-ltg.com | O: 303-322-5570 F: 303-322-5568

F18D_SUSPENDED_SPEC_JAN2023



Circuiting

- Select fixture circuiting from options below
- Some FINA configurations will not accommodate all circuiting options; consult with factory

1	Single Circuit
E	Emergency Circuit only
N	Night Light Circuit only

Battery & Emergency

- Select battery or emergency options if required
- Battery duration is 90 minutes
- Test button is remote to fixture
- For more Battery options, see Pinnacle Resource Guide

0	No Battery
1IRC	Iota 10w Remote
1PB	Bodine 10w Integral
1PRS	Bodine 7w Remote, Self Testing
1PRD	Bodine 10w Remote, Dual Flex
FSG	Factory Select Automatic Load Control Relay (ALCR), UNV
GI	Emergency Transfer Switch (ETS) DR Emergency Control Device, UNV
GB	Bodine GTD, Generator Transfer Device, 120v or 277v

For Approximate Battery Lumen Output

- Multiply battery wattage X fixture LPW shown on Lumen Table
- 10 (watts) x 92.3 (LPW) = 923 battery lumen output

Battery & Emergency Ordering Examples

- Single circuit, 10w integral battery Ordering Code: 1-1PRS
- Emergency circuit only, 10w integral battery Ordering Code: E-1PRS

Finish

- Standard powder-coat textured white, metallic silver, textured black, graphite or bronze painted finish; consult factory for chip of standard paint finishes
- Selecting a fixture finish other than white may impact lumen output; consult factory for more information

W	White <i>(white cord/white canopy)</i>
S	Metallic Silver <i>(grey cord/silver canopy)</i>
BL	Textured Black <i>(black cord/black canopy)</i>
BR	Bronze <i>(white cord/bronze canopy)</i>
GR	Graphite <i>(white cord/graphite canopy)</i>
CC	Custom Color <i>(white cord/color match canopy)</i>

Fixture Options

- Additional options to enhance the fixture and finish of the product

AM	Antimicrobial Paint
DSP	Customer Supplied Battery/Driver/Sensor
GMF	Internal Slow Blow Fuse

Controls

- Pinnacle Lighting offers easy to specify network control solutions that connect to an intelligent centralized system to maximize lighting energy efficiencies or integral sensors for individual fixture control
- Pinnacle Lighting fixtures ship technology ready; commissioning by others
- Controls can only be used with Single Circuit (1) or Emergency Circuit (E)
- Contact factory for any non-standard configurations for layout, placement, or EM options
- One sensor per housing typical, contact factory for more information

	Solution	Components	Network/Sensor	Connection	RQD Drivers	Limitation
DLMFC	Legrand Wattstopper DLM	LMFC-011	Digital Lighting Management (DLM)	Wired, two RJ45 ports	OL2, OL4	None
ENLI	Enlighted IOT	CU-4E	Enlighted, Remote	Enlighted Cable	Any 0-10v	Not available with 347 volt
ENLC	Enlighted Connected Lightign	CU-4E	Enlighted, Remote	Enlighted Cable	Any 0-10v	Not available with 347 volt



Photometrics

Satine Lens

Test # ITL92430
Catalog # F18-AL-840HO
Lumens 3317 lm
Watts 28.2 W
Efficacy 118 LPW

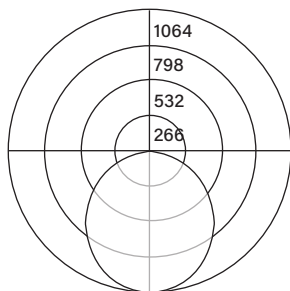

Candela Distribution

Vert Angle	Horizontal Angle
0	1058
5	1064
10	1054
15	1031
20	998
25	958
30	910
35	855
40	794
45	727
50	655
55	579
60	498
65	413
70	326
75	240
80	160
85	93
90	44
95	38
100	33
105	28
110	23
115	18
120	14
125	10
130	7
135	4

Luminance Data (cd/sq.m)

Angle In Degrees	Average 0-Deg	Average 45-Deg	Average 90-Deg
45	6547	6547	6547
55	6286	6286	6286
65	5868	5868	5868
75	5160	5160	5160
85	4381	4381	4381

For all available IES files, please visit our website at pinnacle-ltg.com. Photometry testing in accordance to IESNA-LM-79-08 at an NVLAP accredited testing laboratory. Testing conducted at 25°C ambient conditions

Approvals & Certifications

Construction: Extruded aluminum housing is rolled and welded for seamless finish with minimal trim detail. Aluminum top cover conceals all electrical components. Highly reflective die-formed white painted steel reflector. Wiring access on top of housing.

Shielding: Single piece diffuse lens creating a fully luminous housing. Available with standard satine lens.

Mounting: Aircraft cable, Pendant, Surface and Wall mount available. Aircraft Cable and pendant supplied with 5" (127mm) canopies. Refer to installation instructions for appropriate ceiling detail. Maximum fixture weight is 20 lbs.

LED: 25°C test environment. Lumen output/wattage has a margin of +/- 5%. Luminaire configurations tested in accordance with IES LM-79. Diodes tested in accordance with IES LM-80. Lifetime calculated using IES TM-21. Minimum lifetime greater than 60,000 hours. L70 = 146,500 hours and L90 = 45,000 hours. MacAdam 3-Step Ellipses. Not all products are Lighting Facts listed. For all available IES files, please visit our website at pinnacle-ltg.com.

CRI, CCT & Output: Three lumen packages available. Low (LO), Mid (MO) and High (HO). Custom outputs are available. Specify custom lumens or watts between standard offering listed on CRI, CCT & Output page. 80 CRI is available for 3000K, 3500K, and 4000K. 90 CRI is available for 2700K, 3000K, 3500K, and 4000K. 90 CRI = R9≥50.

Voltage: Universal (U), 120 volt (1), 277 volt (2), 347 volt (3) options available. Must specify OL4 in Driver section when 347 volt (3) is selected. Some FINA configurations will not accommodate all voltage options; consult with factory.

Driver: Standard Driver Option is Advance 0-10V, 1% = PL2. Electronic driver, Power factor is >0.9 with a THD <20%. Driver Lifetime: 50,000 hours at 25°C ambient operating conditions. For more driver options, see Pinnacle Resource Guide on download pages at pinnacle-ltg.com. Some FINA configurations will not accommodate all driver options.

Circuiting: Select from Single circuit (1), Emergency circuit (E) or Night Light circuit (N). Some FINA configurations will not accommodate all circuiting options, consult with factory.

Battery & Emergency: Select battery or emergency options if required. If battery or emergency option is not required, enter 0. Battery duration is 90 minutes as standard. Test button is remote to fixture. For more Battery options, see Pinnacle Resource Guide on download pages at pinnacle-ltg.com.

Finish: Standard powder-coat textured white, metallic silver, textured black, graphite, or bronze painted finish, consult factory for chip of standard paint finishes. Contact factory for additional custom color and finish options.

Controls: DLM utilizes wired network connections for digital control through switching and dimming with 0-10v LED drivers. Enlighted Smart Sensor provides multi-functionality including daylight harvesting and PIR occupancy; for IOT platform using 0-10v LED drivers. Enlighted Smart Sensor provides multi-functionality including daylight harvesting and PIR occupancy; for Connected platform using 0-10v LED drivers.

Labels: ETL Listed conforming to UL1598 in US and CSA 250 in Canada. LO, MO, and HO lumen packages are IC Rated, approved for dry/damp location unless otherwise noted.

Fixture Weight: 20 lbs maximum

Buy American Act compliant

Warranty: FINA LED offered with a 5-year limited warranty. Covers LED, driver and fixture.