

# EDGE EX6B

## 6" Suspended Bidirectional Linear

### Key Features

- 6063-T5 Extruded aluminum housing
- Highly reflective die-formed white painted reflector
- 5-year limited warranty covers LED, driver and fixture
- UL and cUL listed
- Approved for dry/damp location unless otherwise noted
- Maximum fixture weight is 28 lbs for a standard 4' fixture
- Room-Side Maintenance for LED system
- Buy American Act compliant



Example Part #: EX6B-A-O-830HO-830-26'-AC48G1-U-OL2-1-0-W

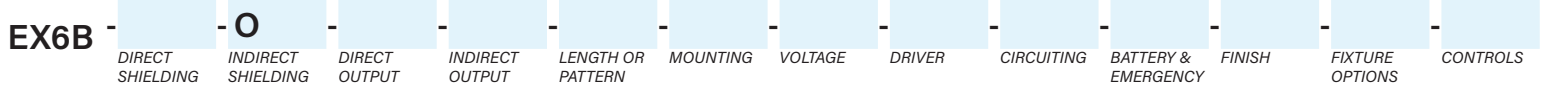

---	O	-----	-----
DIRECT SHIELDING	INDIRECT SHIELDING	DIRECT CRI, CCT & OUTPUT <sup>1</sup>	INDIRECT CRI, CCT & OUTPUT <sup>1</sup>
<b>A</b> - Satine Lens <b>AL</b> - Drop Lens <i>Shielding pg. 2</i>	<b>O</b> - Open <i>Shielding pg. 2</i>	<b>27</b> - 2700K <b>30</b> - 3000K <b>35</b> - 3500K <b>40</b> - 4000K <b>CL</b> - Custom Lumens <b>CW</b> - Custom Watts <i>Lumen Output pg. 2</i>	<b>27</b> - 2700K <b>30</b> - 3000K <b>35</b> - 3500K <b>40</b> - 4000K <b>CL</b> - Custom Lumens <b>CW</b> - Custom Watts <i>Lumen Output pg. 2</i>

---	-----	-	---	-
LENGTH OR PATTERN <sup>2</sup>	MOUNTING <sup>3</sup>	VOLTAGE	DRIVER	CIRCUITING
<b>---</b> - Individual Fixture <b>---</b> - Continuous Row <b>L_X</b> - L Shape <b>R_X</b> - Rectangle <b>S</b> - Square <b>U_X</b> - U-Shape <b>M</b> - Mod Layout <i>Length and Pattern pg. 2-3</i>	<b>AC_G</b> - (M)AC to Grid <b>AC_JB</b> - (M)AC to J Box <b>AC_ST</b> - (M)AC to Structure <b>WA</b> - Wall Mount <b>AC5_G</b> - 5" non-power canopy <b>AC5_JB</b> - 5" non-power canopy <b>SQ_G</b> - 5" square canopy <b>SQ_JB</b> - 5" square canopy <i>Mounting pg. 3</i>	<b>U</b> - Universal ( <i>120 thru 277V</i> ) <b>1</b> - 120V <b>2</b> - 277V <b>3</b> - 347V <i>Voltage pg. 4</i>	<b>FSD</b> - Factory Select Driver ( <i>1%, 0-10v</i> ) <b>PL2</b> - Advance Xitanium ( <i>1%, 0-10v</i> ) <b>OL4</b> - Osram 347v ( <i>1%, 0-10v</i> ) <b>EE1</b> - eldoLED ECOdrive ( <i>1%, 0-10v</i> ) <b>ES1</b> - eldoLED SOLOdrive ( <i>0.1%, 0-10v</i> ) <b>LH1</b> - Lutron Hi-lume ( <i>1%, EcoSystem</i> ) <b>PS1</b> - Advance Xitanium ( <i>50%/100%</i> ) <b>OL2</b> - Osram ( <i>1%, 0-10v</i> ) <i>Driver pg. 4</i>	<b>1</b> - Single Circuit <b>2</b> - Dual Circuit <b>M</b> - Multi Circuit <b>E</b> - Emergency ( <i>entire fixture</i> ) <b>N</b> - Night Light ( <i>entire fixture</i> ) <i>Circuiting pg. 5</i>

---	---	-----	---
BATTERY & EMERGENCY <sup>4</sup>	FINISH	FIXTURE OPTIONS <sup>5</sup>	CONTROLS
<b>O</b> - None <b>FSG</b> - Factory Select ALCR <b>FBS</b> - Factory Select Battery <b>GI</b> - Iota ETS DR <b>GB</b> - Bodine GTD <b>P</b> - Bodine 10W Integral <b>IC</b> - Iota 10W Integral ( <i>CEC Listed</i> ) <b>E</b> - Emergency Circuit Section <b>N</b> - Night Light Circuit Section <b>L</b> - Life Safety Circuit Section <i>Battery and Emergency pg. 5</i>	<b>W</b> - White <b>S</b> - Metallic Silver <b>BL</b> - Textured Black <b>BR</b> - Bronze <b>GR</b> - Graphite <b>CC</b> - Custom Color <i>Finish pg. 5</i>	<b>MRF</b> - Fixed MR16 ( <i>Halogen</i> ) <b>LMRF</b> - Fixed MR16 ( <i>LED</i> ) <b>XLED</b> - Fixed Xicato ( <i>LED</i> ) <b>MRA</b> - Adjustable MR16 ( <i>Halogen</i> ) <b>DSP</b> - Customer Supplied Battery/Driver/Sensor <b>LMRA</b> - Adjustable MR16 ( <i>LED</i> ) <i>Fixture Options pg. 5</i>	<i>Pinnacle is able to accommodate different control solutions from different manufacturers. Consult Factory for more information.</i>

<sup>1</sup>When specifying CRI- CCT & OUTPUT the first \_ is for specifying either **8** - 80CRI or **9** - 90CRI. The ending \_ are for specifying output, example **HO** - High Output. See output charts for more information. <sup>2</sup>Individual fixtures come in 2', 3', 4', 5', 6' & 8' lengths. Continuous row come in 1' increments. For Mod layouts specify pattern shape and overall dimensions. Example: L6x4: L pattern that is 6'x4'. <sup>3</sup>Specify AC Cable: Standard single AC = AC or Movable AC = MAC; Specify AC length standard AC is 48"; Specify grid: G1=15/16", G9=9/16", GS=Screw Slot. Example: AC48G1 <sup>4</sup>Enter quantity for Battery and Emergency, Example 2P. <sup>5</sup>MRF, and LMRF options not available with 277v.

Specifications and dimensions subject to change without notice. Specification sheets that appear on pinnacle-ltg.com are the most recent version and supersede all other previously printed or electronic versions.



## Direct Shielding

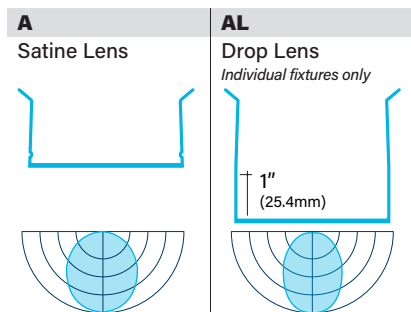

## Indirect Shielding

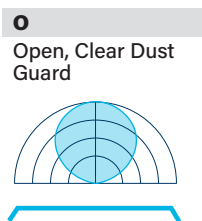

## Output

- Specify either 80 or 90 CRI
- Longer lead-time may apply for 90 CRI. Consult factory.
- 90 CRI = R9≥50

## Custom Output- Lumens OR Wattage

<b>CL</b> _____	Specify CRI, CCT and desired lumens (i.e. CL835700)	Specify lumens between standard offering listed below. Lumens are specified per color temp
<b>CW</b> _____	Specify CRI, CCT and desired wattage (i.e. CW9407)	Specify watts between standard offering listed below

### 80 CRI

	Color	Output	Watts <i>per foot</i>	Direct Shielding				Indirect Shielding	
				<b>A</b> Satine <i>Lumens/ft</i>		<b>AL</b> Drop <i>Lumens/ft</i>		<b>O</b> Open <i>Lumens/ft</i>	
				<i>LPW</i>	<i>LPW</i>	<i>LPW</i>	<i>LPW</i>	<i>LPW</i>	
<b>830</b>	3000K	Standard	4.3	419	96.6	478	110.2	556	128.2
<b>830HO</b>	3000K	High	8.9	791	88.8	910	102.1	1053	118.1
<b>835</b>	3500K	Standard	4.3	431	99.4	491	113.2	572	131.9
<b>835HO</b>	3500K	High	8.9	814	91.3	936	105.0	1083	121.5
<b>840</b>	4000K	Standard	4.3	439	101.2	501	115.5	583	134.4
<b>840HO</b>	4000K	High	8.9	830	93.1	954	107.0	1104	123.9

### 90 CRI

<b>927</b>	2700K	Standard	4.3	331	76.3	377	86.9	439	101.2
<b>927HO</b>	2700K	High	8.9	625	70.1	719	80.7	832	93.4
<b>930</b>	3000K	Standard	4.3	386	89.0	441	101.7	513	118.3
<b>930HO</b>	3000K	High	8.9	729	81.8	839	94.1	970	108.8
<b>935</b>	3500K	Standard	4.3	388	89.5	442	101.9	515	118.7
<b>935HO</b>	3500K	High	8.9	732	82.1	842	94.5	974	109.3
<b>940</b>	4000K	Standard	4.3	392	90.4	447	103.1	521	120.1
<b>940HO</b>	4000K	High	8.9	741	83.1	851	95.5	985	110.5

## Length

- All individual units cannot be joined, end plates are factory installed and cannot be removed
- Add 1/2" (12.7mm) to the overall length of the Continuous Runs to account for end caps
- For patterns refer to Pattern section on next page

2	3	4	5	6	8	—
Indiv. Fixture	Indiv. Fixture	Indiv. Fixture	Indiv. Fixture	Indiv. Fixture	Indiv. Fixture	Cont. Run <i>Specify nominal overall row length to the 1'</i>
24" (609.6mm)						
	36" (914.4mm)					
		48" (1219.2mm)				
			60" (1524mm)			
				72" (1828.8mm)		
					96" (2438.4mm)	
						Specify to the 1' >>>



**Pattern**

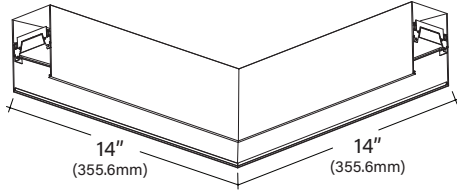

- Specify pattern shape and overall dimensions (includes corner dimensions)
- Refer to dimensions table below for available standard lengths
- All connectors are direct only
- 90 degree horizontal corners are 14"x14" (overall, outside dimension)
- Angles and shapes not shown require Mod Pattern; consult factory
- Not all drivers available with all patterns; consult factory
- Only available with A Lens

<b>S_</b>	<b>R_x</b>	<b>U_x_x</b>	<b>L_x</b>	<b>M</b>
Square Provide A dimension Example: <b>S4'</b> Nominal Lengths 4'x4' Minimal Length- 4'4"x4'4"	Rectangle Provide AxB dimensions Example: <b>R4'x4'</b> Nominal Lengths 4'x4' Minimal Length- 4'4"x4'4"	U-Shape Provide AxBxC dimensions Example: <b>U3'x4'x3'</b> Nominal Lengths 3'x4'x3' Minimal Length- 3'2"x4'4"x3'2"	L-Shape Provide AxB dimensions Example: <b>L3'x3'</b> Nominal Lengths 3'x3' Minimal Length- 3'2"x3'2"	Mod Layout For patterns or lengths not shown or standard

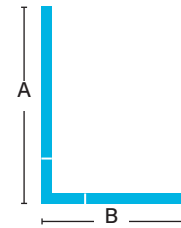
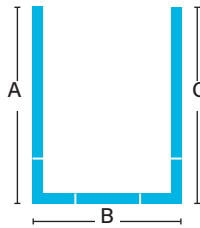
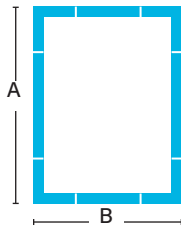
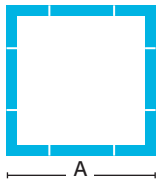

**Mounting**

- Specify cable length in ordering code (AC48G1)
- Standard specifiable lengths are 48", 120", 240" and 350"
- End plates and standard white power cord attached at factory
- Aircraft cable (AC) mounts on 4' (1219.2mm) and 8' (2438.4mm) centers
- Maximum movable mounting locations are 12" from end of 4' fixture and 18" from end of 8' fixture
- Aircraft Cable supplied with 5" (127mm) power and 2" (50.8mm) non-power canopies

- Canopies and pendants match fixture finish, power cords are white, grey, or black depending on fixture finish. See Finish section for additional details.
- Approved for dry/damp location unless otherwise noted
- Refer to installation instructions during installation at the job site
- Maximum fixture weight is 28 lbs for a standard 4' fixture
- AC\_\_GS and MAC\_\_GS - works with screw slot and bolt slot grid ceiling types

<b>AC_G1</b>	Aircraft Cable 1" (15/16") T-Bar
<b>AC_G9</b>	Aircraft Cable 9/16" T-Bar
<b>AC_GS</b>	Aircraft Cable Screw Slot T-Bar
<b>AC_JB</b>	Aircraft Cable Junction Box
<b>AC_ST</b>	Aircraft Cable Structure
<b>AC5_G</b>	Aircraft Cable 5" (127mm) Non-Power Canopy
<b>AC5_JB</b>	Aircraft Cable 5" (127mm) Non-Power Canopy
<b>SQ_G</b>	Aircraft Cable 5" (127mm) Square Canopy
<b>SQ_JB</b>	Aircraft Cable 5" (127mm) Square Canopy
<b>MAC_G1</b>	Moveable AC 1" (15/16") T-Bar
<b>MAC_G9</b>	Moveable AC 9/16" T-Bar
<b>MAC_GS</b>	Moveable AC Screw Slot T-Bar
<b>MAC_JB</b>	Moveable AC Junction Box
<b>MAC_ST</b>	Moveable AC Structure
<b>MAC5_G</b>	Moveable AC 5" (127mm) Non-Power Canopy
<b>MAC5_JB</b>	Moveable AC 5" (127mm) Non-Power Canopy
<b>MSQ_G</b>	Moveable AC 5" (127mm) Square Canopy
<b>MSQ_JB</b>	Moveable AC 5" (127mm) Square Canopy
<b>WA</b>	Wall Mount

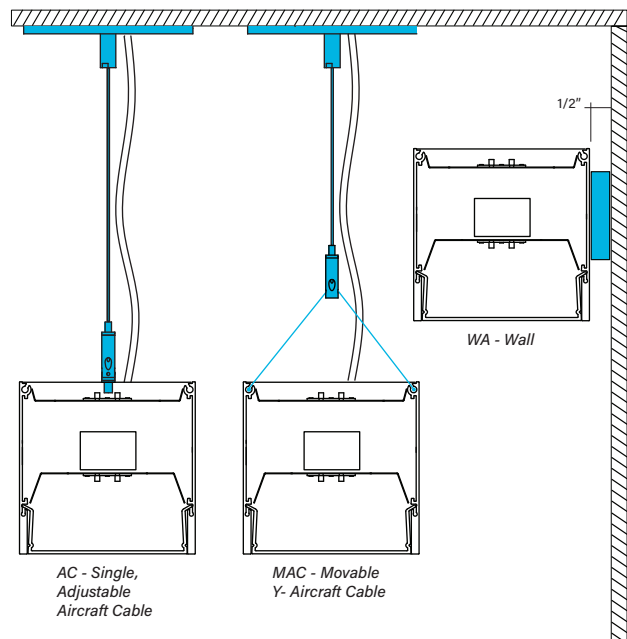

Specifications and dimensions subject to change without notice. Specification sheets that appear on pinnacle-ltg.com are the most recent version and supersede all other previously printed or electronic versions.



## Voltage

- Some EX6B configurations will not accommodate all voltage options; consult with factory

<b>U</b>	Universal
<b>1</b>	120 volt
<b>2</b>	277 volt
<b>3</b>	347 volt

## Driver

- Standard Driver Option = FSD
- Driver Lifetime: 50,000 hours at 25°C ambient operating conditions
- For more driver options see Pinnacle Resource Guide
- Some EX6B configurations will not accommodate all driver options; consult with factory

0-10V Drivers	
<b>FSD</b>	Factory Select Driver 1%, 0-10v
<b>PL2</b>	Signify Advance Xitanium 1%, 0-10v
<b>PL4</b>	Advance Xitanium 347v 1%, 0-10v, requires 347v
<b>OL2</b>	Osram Optotronic, 1%, 0-10v
<b>OL4</b>	Osram Optotronic 347v, 1% 0-10v, requires 347v option
<b>EE1</b>	eldoLED ECOdrive 1%, 0-10v Logarithmic
<b>EE2</b>	eldoLED ECOdrive 1%, 0-10v Linear
<b>ES1</b>	eldoLED SOLOdrive 0-10v, 0.1% Logarithmic
<b>ES2</b>	eldoLED SOLOdrive 0-10v, 0% Linear
DALI Drivers	
<b>EE3</b>	eldoLED ECOdrive .1%, DALI (logarithmic)
<b>ES3</b>	eldoLED SOLOdrive .1%, DALI (logarithmic)
<b>OD1</b>	Osram Optotronic 1%, DEXAL
<b>OD2</b>	Osram Optotronic 1%, DALI 2 Channel
Lutron Drivers	
<b>LH1</b>	Lutron Hi-lume Soft-on, Fade-to-black 1%, EcoSystem, LDE1
<b>LH4</b>	Lutron Hi-Lume 1%, 2-wire, Lutron-LTEA2W, 120v only
Alternate Drivers	
<b>PS1</b>	Signify Advance Xitanium Step Dimming 50%/100%
<b>EH1</b>	ELV 120v only, 0-10v universal

## How to specify Circuiting, Battery and Emergency

- Select fixture circuiting from options below
  - Some EX6B configurations will not accommodate all circuiting options, consult with factory

### Circuiting

<b>1</b>	Single Circuit
<b>2</b>	Dual Circuit ( <i>direct/indirect</i> )
<b>M</b>	Multi Circuit
<b>E</b>	Emergency Circuit only
<b>N</b>	Night Light Circuit only

- Battery and emergency section options are available in addition to fixture circuit
  - Select battery and emergency section options below; factory shop drawing required
  - Some EX6B configurations will not accommodate all circuiting options, consult with factory

### Battery and/or Emergency If Required

<b>0</b>	No battery or specific emergency section required
----------	---



## Battery

- Select battery section type if required, indicate total QTY. *Example 1E*
- 90 minute battery runtime; test button is integral
- No battery option available for 2' lengths

- Entire direct fixture housing is on battery for lengths up to 5'
- Half of direct fixture is on battery for 6' or 8' housing lengths
- For more battery options available, see Pinnacle Resource Guide

<b>0</b>	No Battery
<b>_FSB</b>	Factory Select Battery (10w option)
<b>_FSBST</b>	Factory Select Battery (Self Testing)
<b>_IC</b>	lota 10w Integral
<b>_ILL</b>	lota 10w Integral Lithium, Self Testing
<b>_IRH</b>	lota 20w Remote
<b>_P</b>	Bodine 10w Integral
<b>_PLL</b>	Bodine 10w Integral Lithium, Self Testing
<b>_PRH</b>	Bodine 20w Remote

### For Approximate Battery Lumen Output

- Multiply battery wattage X fixture LPW shown on Lumen Table
- 92.3 (LPW) x 10 (watts) = 923 battery lumen output

## Emergency

- Select emergency section type if required, indicate total QTY. *Example 1E*
- Combine battery and emergency section ordering codes if both options are selected

<b>_FSG</b>	Factory Select Automatic Load Control Relay (ALCR), UNV
<b>_GI</b>	Emergency Transfer Switch (ETS) DR Emergency Control Device, UNV
<b>_GB</b>	Bodine GTD, Generator Transfer Device, 120v or 277v
<b>_E</b>	Emergency circuit section
<b>_N</b>	Night Light circuit section
<b>_L</b>	Life Safety circuit section NO THROUGH WIRE

### Battery OR Emergency Ordering Examples

- Single circuit, 10w Integral Battery      Ordering Code: 1-1P
- Emergency only, 10w Integral Battery      Ordering Code: E-1P
- Single circuit, GTD required      Ordering Code: 1-1G

### Combination Section Ordering Examples

- Single circuit, (1) 10w battery, (1) emergency section      Ordering Code: 1-1P1E
- Multi circuit, (2) 10w battery, (2) emergency sections      Ordering Code: M-2P2E
- Single circuit, (1) night light section      Ordering Code: 1-1N

## Finish

- Standard powder-coat textured white, metallic silver, textured black, graphite or bronze painted finish; consult factory for chip of standard paint finishes
- Selecting a fixture finish other than white may impact lumen output; consult factory for more information

<b>W</b>	White ( <i>white cord/white canopy</i> )
<b>S</b>	Metallic Silver ( <i>grey cord/silver canopy</i> )
<b>BL</b>	Textured Black ( <i>black cord/black canopy</i> )
<b>BR</b>	Bronze ( <i>white cord/bronze canopy</i> )
<b>GR</b>	Graphite ( <i>white cord/graphite canopy</i> )
<b>CC</b>	Custom Color ( <i>white cord/color match canopy</i> )

## Fixture Options

- Additional options to enhance the fixture and finish of the product
- Consult factory for MR16 configurations

<b>MRA</b>	Adjustable MR16 Halogen
<b>LMRA</b>	Adjustable MR16 LED
<b>XLED</b>	Fixed Xicato LED
<b>MRF</b>	Fixed MR16 Halogen
<b>DSP</b>	Customer Supplied Battery/Driver/Sensor
<b>LMRF</b>	Fixed MR16 LED

## Controls

- Pinnacle is able to accommodate different control solutions from different manufacturers. Consult Factory for more information.



Photometrics

Satine - Open

Test #	ITL86588
Catalog #	EX6B-A-O-40-40-4
Lumens	4088 lm
Watts	34.7 W
Efficacy	118 LPW

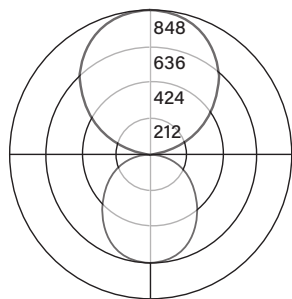

Candela Distribution

Vert Angle	Horizontal Angle				
	0	22.5	45	67.5	90
0	639	639	639	639	639
5	635	635	635	636	635
15	610	607	609	609	607
25	561	555	557	556	554
35	492	486	487	485	482
45	406	401	403	399	397
55	313	309	309	307	306
65	216	214	214	213	211
75	122	120	121	120	119
85	37	36	35	35	35
95	9	8	4	4	4
105	113	114	104	106	104
115	278	276	275	281	278
125	441	436	441	442	445
135	585	577	580	579	580
145	695	681	687	684	683
155	772	761	766	763	761
165	820	814	817	815	815
175	844	844	844	844	844
180	848	848	848	848	848

Luminance Data (cd/sq.m)

Angle In Degrees	Average 0-Deg	Average 45-Deg	Average 90-Deg
45	3701	3673	3626
55	3519	3473	3439
65	3298	3267	3220
75	3048	3023	2972
85	2716	2565	2565

For all available IES files, please visit our website at [pinnacle-ltg.com](http://pinnacle-ltg.com). Photometry testing in accordance to IESNA-LM-79-08 at an NVLAP accredited testing laboratory. Testing conducted at 25°C ambient conditions

Applications & Certificates

**Construction:** 6063-T5 Extruded aluminum housing. Highly reflective die-formed white painted reflector.

**Shielding:** Diffuse snap-in acrylic lens, removable for maintenance. Clear dust guard offered standard with fixture.

**Mounting:** Aircraft cable and wall mount available. Select from 2 aircraft cable options. Select the straight aircraft cable that mounts on 4'-0" (1219.2mm) and 8'-0" (2438.4mm) centers or the movable adjustable Y-cable mount. The Y-Cable design allows for adjustable mounting locations. Aircraft Cable supplied with 5" (127mm) power and 2" (50.8mm) non-power canopies. Refer to installation instructions for appropriate ceiling detail. Canopies are painted white unless otherwise specified. Maximum fixture weight is 28 lbs for a standard 4' fixture.

**LED:** 25°C test environment. Lumen output/wattage has a margin of +/- 5%; 2' or 3' lengths may have a greater wattage deviation. Luminaire configurations tested in accordance with IES LM-79. Diodes tested in accordance with IES LM-80. Lifetime calculated using IES TM-21. Minimum lifetime greater than 60,000 hours. L70 = 136,200 hours and L90 = 41,100 hours. MacAdam 3-Step Ellipses. Not all products are Lighting Facts listed. For all available IES files, please visit our website at [pinnacle-ltg.com](http://pinnacle-ltg.com).

**CRI, CCT & Lumen Output:** Two lumen packages available. Standard and High (HO). Custom outputs are available. Specify custom lumens or watts between standard offering listed on CRI, CCT & Output page. 80 CRI is available for 3000K, 3500K, and 4000K. 90 CRI is available for 2700K, 3000K, 3500K, and 4000K. 90 CRI = R9≥50.

**Voltage:** Universal (U), 120 volt (1), 277 volt (2) and 347 volt (3) options available. Must specify OL4 in Driver section when 347 volt (3) is selected. Some EX configurations will not accommodate all voltage options; consult with factory.

**Driver:** Standard Driver Option is Advance Xitanium 0-10V, 1% = PL2. Electronic driver, Power factor is >0.9 with a THD <20%. Driver Lifetime: 50,000 hours at 25°C ambient operating conditions. Ambient operating range: -20°F/-30°C to 86°F/30°C. For more driver options, see Pinnacle Resource Guide. Some EX configurations will not accommodate all driver options.

**Circuiting:** Select from single circuit (1), dual circuit (2), Multi circuit (M), Emergency circuit (E) or Night Light circuit (N). For emergency circuiting situations that require no through wire or circuit separation, Life Safety Circuit should be selected. This will provide a separate power feed and only the Life Safety Circuit in that section. Some EX configurations will not accommodate all circuiting options; consult with factory.

**Battery & Emergency:** Select battery or emergency options if required. If battery or emergency option is not required, enter 0. Battery duration is 90 minutes as standard. Test button is integral to fixture. For more Battery options, see Pinnacle Resource Guide.

**Finish:** Standard powder-coat textured white, metallic silver, graphite, textured black or bronze painted finish; consult factory for chip of standard paint finishes. Canopies painted white unless specified differently in the options section of the part number. Contact factory for additional custom color and finish options.

**MR16:** Ideal for conference rooms, corridors, wall washing, retail spaces and training facilities where accent lighting is required. Fully enclosed compartment eliminates light from entering into our fixture areas. For LED and Halogen lamps (lamps are not included). Consult factory for other lamp types. Standard 60 watt max LED electronic transformer (120v), 50 watt max halogen lamp electronic transformer (120v), MR16 installed as an independent circuit. MR16 to match fixture voltage. 277v not available. Consult factory for MR16 configurations. Pinnacle's MR16 applications are to be used with Soraa lamps with a maximum of 13 transformers on one circuit.

**Controls:** Consult factory.

**Labels:** UL and cUL Listed. Standard and HO lumen packages are approved for dry/damp location unless otherwise noted.

**Fixture Weight:** Maximum fixture weight is 28 lbs for a standard 4' fixture.

**Buy American Act Compliant**

**Warranty:** EX LED offered with a 5-year limited warranty. Covers LED, driver and fixture.