

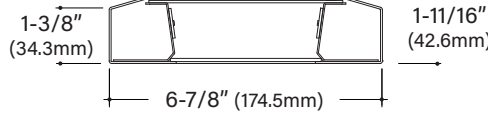

LINERO L6DI-A

Single Source Linear



Key Features

- One piece die-formed 18 gauge steel housing
- Highly reflective die-formed white painted steel reflector
- Die-cast aluminum end caps
- LINERO offered with a 5-year limited warranty that covers LED, driver and fixture
- UL and cUL Listed
- Approved for dry/damp location
- Maximum fixture weight is 17 lbs per standard 4' fixture
- Room-Side Maintenance for LED system
- Buy American Act compliant



Example Part #: L6DI-A-70-835HO-26'-AC48G1-U-OL2-1-0-W

L6DI-A

HOUSING - DISTRIBUTION - CRI, CCT & OUTPUT - LENGTH - MOUNTING - VOLTAGE - DRIVER - CIRCUITING - BATTERY & EMERGENCY - FINISH - FIXTURE OPTIONS - CONTROLS

L6DI-A	---	-----	-----
HOUSING	DISTRIBUTION	CRI, CCT & OUTPUT ^{QS} 1	LENGTH ²
L6DI-A - LINERO 6 with Satine Lens ^{QS} <i>Shielding pg. 2</i>	40 - 40% Direct / 60% Indirect ^{QS} 70 - 70% Direct / 30% Indirect ^{QS} 100 - 100% Direct ^{QS} <i>Shielding pg. 2</i>	27 - 2700K 30 - 3000K 35 - 3500K (available with BIOS) 40 - 4000K (available with BIOS) CL - Custom Lumens CW - Custom Watts <i>Lumen Output pg. 2-5</i>	-- - Individual Fixture ^{QS} --- - Continuous Row ^{QS} <i>Length pg. 5</i>
---	---	---	---
MOUNTING ³	VOLTAGE	DRIVER	CIRCUITING
AC_G - AC to Grid ^{QS} AC_JB - AC to J Box ^{QS} AC_ST - AC to Structure ^{QS} AC5_G - 5" Non-Power Canopy AC5_JB - 5" Non-Power Canopy SQ_G - 5" Square Canopy SQ_JB - 5" Square Canopy WA - Wall Mount <i>Mounting pg. 5</i>	U - Universal ^{QS} <i>(120 thru 277V)</i> 1 - 120V ^{QS} 2 - 277V ^{QS} 3 - 347V <i>Voltage pg. 6</i>	FSD - Factory Select Driver (1%, 0-10v) ^{QS} PL2 - Advance Xitanium (0-10v, 1%) ^{QS} OL5 - Osram (1%, 0-10v, AUX) OD1 - Osram (1%, 0-10v, DEXAL) EE1 - eldoLED ECOdrive (1%, 0-10v) ES1 - eldoLED SOLOdrive (0%, 0-10v) LH1 - Lutron Hi-lume (1%, EcoSystem) ^{QS} OL2 - Osram (1%, 0-10v) ^{QS} <i>Driver pg. 6</i>	1 - Single Circuit ^{QS} M - Multi Circuit E - Emergency ^{QS} <i>(entire fixture)</i> N - Night Light ^{QS} <i>(entire fixture)</i> <i>Circuiting pg. 6</i>
---	---	---	---
BATTERY & EMERGENCY ⁴	FINISH	FIXTURE OPTIONS ⁵	CONTROLS ⁶
0 - None ^{QS} FSG - Factory Select ALCR GI - Iota ETS DR GB - Bodine GTD E - Emergency circuit section N - Night Light circuit section L - Life Safety circuit section ILL - Iota 10w Integral PLL - Bodine 10w Integral Lithium <i>Battery and Emergency pg. 6</i>	W - White ^{QS} S - Metallic Silver BL - Textured Black BR - Bronze GR - Graphite CC - Custom Color <i>Finish pg. 7</i>	QS - QuickShip ^{QS} DSP - Customer Supplied Battery/Driver/ Sensor <i>Fixture Options pg. 7</i>	DLMFC - Wattstopper DLM (wired) EASYS - Philips EasySense (wireless) SNSLM - Encelium Sensilum (wireless) WVLX - Eaton zWaveLinX (wireless) VDO - Lutron Vive Sensor (wireless) VRF - Lutron Vive Connected (wireless) ENL - Enlighted (wireless) <i>Controls pg. 7</i>

¹When specifying SOURCE the first ___ is for specifying either **B** - 80CRI, **9** - 90CRI or **B** - BIOS. The ending ___ are for specifying output, example **HO** - High Output. When specifying BIOS use **B** and then specify color temperature, either 3500K or 4000K, and output, example **B35HO** - BIOS 3500K High Output. See output charts for more information. BIOS dynamic available, please contact factory for more information. For QuickShip CRI, CCT & Output see chart on page 7 ²Individual fixtures come in 4', 6' & 8' lengths. Continuous rows available in 2' increments, starting at 4'. ³Specify AC Cable length, standard AC is 48"; Specify grid: G1=15/16", G9=9/16", GS=Screw Slot. Example AC48G1. ⁴Enter quantity for Battery and Emergency, Example 2PL. ⁵QS must be used in fixture options section of part number to qualify. 1/8" increments not available for QS. ⁶Controls can only be used with Single Circuit (1) or Emergency Circuit (E). See Controls chart on page 6 for driver options and more information.

Specifications and dimensions subject to change without notice. Specification sheets that appear on pinnacle-ltg.com are the most recent version and supersede all other previously printed or electronic versions.



Distribution

40

40% Direct / 60% Indirect

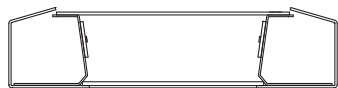

70

70% Direct / 30% Indirect

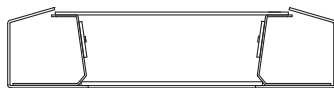

100

100% Direct

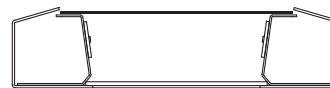

40% Direct Source: Static White

- Specify either 80 or 90 CRI
- Longer lead-time may apply for 90 CRI. Consult factory
- 80 CRI = R9≥19 and 90 CRI = R9≥61

Custom Output- Lumens OR Wattage

CL _____ Specify CRI, CCT and desired lumens (i.e. CL835950)

Specify lumens between standard offering listed below. Lumens are specified per color temp

CW _____ Specify CRI, CCT and desired wattage (i.e. CW9409.5)

Specify watts between standard offering listed below

80 CRI

	Color	Lumens per foot	Shielding	
			A Satine Watts/ft	LPW
830LO	3000K	400	2.8	144.7
830	3000K	600	4.0	150.4
830HO	3000K	850	5.7	149.1
830VHO	3000K	1250	8.4	148.7
835LO	3500K	400	2.7	149.7
835	3500K	600	3.9	155.7
835HO	3500K	850	5.5	154.4
835VHO	3500K	1250	8.1	154.0
840LO	4000K	400	2.7	150.4
840	4000K	600	3.8	156.3
840HO	4000K	850	5.5	155.1
840VHO	4000K	1250	8.1	154.7

90 CRI

927LO	2700K	400	3.4	118.3
927	2700K	600	4.9	125.2
927HO	2700K	850	6.8	125.3
927VHO	2700K	1250	10.1	123.4
930LO	3000K	400	3.3	121.1
930	3000K	600	4.6	129.4
930HO	3000K	850	6.6	129.6
930VHO	3000K	1250	9.8	127.7
935LO	3500K	400	3.2	123.7
935	3500K	600	4.5	132.2
935HO	3500K	850	6.4	132.4
935VHO	3500K	1250	9.6	130.5
940LO	4000K	400	3.3	122.8
940	4000K	600	4.6	131.2
940HO	4000K	850	6.5	131.4
940VHO	4000K	1250	9.7	129.5

¹LPW and watts/ft based off 96" fixture size.

Specifications and dimensions subject to change without notice. Specification sheets that appear on pinnacle-ltg.com are the most recent version and supersede all other previously printed or electronic versions.

Designed in Denver, CO • USA | pinnacle-ltg.com | O: 303-322-5570 F: 303-322-5568

L6DI_LED_SPEC_JUNE2022



40% Direct Source: BIOS¹

- CRI >84, R9 >90
- Spectrum focused lighting for circadian stimulus
- High EML or M/P ratio: .8 for 3500K, .9 for 4000K
- COI: ≤3.3
- Available for use with most Driver or Control options

Custom Output- Lumens OR Wattage

CLB _____	Specify CRI, CCT and desired lumens (i.e. CL835950)	<i>Specify lumens between standard offering listed below. Lumens are specified per color temp</i>
CWB _____	Specify CRI, CCT and desired wattage (i.e. CW9409.5)	<i>Specify watts between standard offering listed below</i>

80 CRI

	Color	Lumens <i>per foot</i>	Shielding A	
			Satine <i>Watts/ft</i>	<i>LPW</i>
835LO	3500K	400	4.5	89.6
835	3500K	600	6.7	88.9
835HO	3500K	850	9.8	86.7
835VHO	3500K	1250	15.0	83.1
840LO	4000K	400	4.3	92.0
840	4000K	600	6.6	91.3
840HO	4000K	850	9.5	89.1
840VHO	4000K	1250	14.6	85.4

70% Direct Source: Static White¹

Custom Output- Lumens OR Wattage

CL _____	Specify CRI, CCT and desired lumens (i.e. CL835950)	<i>Specify lumens between standard offering listed below. Lumens are specified per color temp</i>
CW _____	Specify CRI, CCT and desired wattage (i.e. CW9409.5)	<i>Specify watts between standard offering listed below</i>

80 CRI

	Color	Lumens <i>per foot</i>	Shielding A	
			Satine <i>Watts/ft</i>	<i>LPW</i>
830LO	3000K	400	3.6	111.6
830	3000K	600	5.4	111.7
830HO	3000K	850	7.6	111.6
830VHO	3000K	1250	11.6	108.1
835LO	3500K	400	3.5	115.5
835	3500K	600	5.2	115.7
835HO	3500K	850	7.4	115.6
835VHO	3500K	1250	11.2	112.1
840LO	4000K	400	3.4	116.0
840	4000K	600	5.2	116.0
840HO	4000K	850	7.3	116.1
840VHO	4000K	1250	11.1	112.6

90 CRI

927LO	2700K	400	4.3	93.8
927	2700K	600	6.4	93.9
927HO	2700K	850	9.2	92.7
927VHO	2700K	1250	13.8	90.5
930LO	3000K	400	4.1	97.0
930	3000K	600	6.2	96.8
930HO	3000K	850	8.9	95.9
930VHO	3000K	1250	13.3	93.7
935LO	3500K	400	4.0	99.3
935	3500K	600	6.1	98.9
935HO	3500K	850	8.7	98.0
935VHO	3500K	1250	13.1	95.8
940LO	4000K	400	4.1	98.4
940	4000K	600	6.1	98.2
940HO	4000K	850	8.7	97.3
940VHO	4000K	1250	13.2	95.0

¹LPW and watts/ft based off 96" fixture size.



70% Direct Source: BIOS¹

Custom Output- Lumens OR Wattage

CLB _____	Specify CRI, CCT and desired lumens (i.e. CL835950)	<i>Specify lumens between standard offering listed below. Lumens are specified per color temp</i>
CWB _____	Specify CRI, CCT and desired wattage (i.e. CW9409.5)	<i>Specify watts between standard offering listed below</i>

80 CRI

	Color	Lumens <i>per foot</i>	Shielding A	
			Satine <i>Watts/ft</i>	<i>LPW</i>
835LO	3500K	400	5.4	73.5
835	3500K	600	8.3	72.0
835HO	3500K	850	12.0	70.6
835VHO	3500K	1250	18.9	66.0
840LO	4000K	400	5.3	75.5
840	4000K	600	8.1	73.9
840HO	4000K	850	11.7	72.5
840VHO	4000K	1250	18.4	67.9

100% Direct Output

Custom Output- Lumens OR Wattage

CL _____	Specify CRI, CCT and desired lumens (i.e. CL835950)	<i>Specify lumens between standard offering listed below. Lumens are specified per color temp</i>
CW _____	Specify CRI, CCT and desired wattage (i.e. CW9409.5)	<i>Specify watts between standard offering listed below</i>

80 CRI

	Color	Lumens <i>per foot</i>	Shielding A	
			Satine <i>Watts/ft</i>	<i>LPW</i>
830LO	3000K	400	3.6	111.1
830	3000K	600	5.4	111.2
830HO	3000K	850	7.6	111.1
830VHO	3000K	1250	11.6	107.6
835LO	3500K	400	3.5	115.0
835	3500K	600	5.2	115.1
835HO	3500K	850	7.4	115.1
835VHO	3500K	1250	11.2	111.6
840LO	4000K	400	3.5	115.5
840	4000K	600	5.2	115.6
840HO	4000K	850	7.4	115.6
840VHO	4000K	1250	11.2	112.0

90 CRI

	Color	Lumens	Shielding A	
			Satine <i>Watts/ft</i>	<i>LPW</i>
927LO	2700K	400	4.3	93.4
927	2700K	600	6.4	93.4
927HO	2700K	850	9.2	92.3
927VHO	2700K	1250	13.9	90.0
930LO	3000K	400	4.1	96.6
930	3000K	600	6.2	96.3
930HO	3000K	850	8.9	95.5
930VHO	3000K	1250	13.4	93.2
935LO	3500K	400	4.0	98.8
935	3500K	600	6.1	98.4
935HO	3500K	850	8.7	97.6
935VHO	3500K	1250	13.1	95.3
940LO	4000K	400	4.1	97.9
940	4000K	600	6.1	97.7
940HO	4000K	850	8.8	96.9
940VHO	4000K	1250	13.2	94.6

¹LPW and watts/ft based off 96" fixture size.

Specifications and dimensions subject to change without notice. Specification sheets that appear on pinnacle-ltg.com are the most recent version and supersede all other previously printed or electronic versions.



100% Direct Source: BIOS¹

Custom Output- Lumens OR Wattage

CLB _____	Specify CRI, CCT and desired lumens (i.e. CL835950)	<i>Specify lumens between standard offering listed below. Lumens are specified per color temp</i>
CWB _____	Specify CRI, CCT and desired wattage (i.e. CW9409.5)	<i>Specify watts between standard offering listed below</i>

80 CRI

	Color	Lumens <i>per foot</i>	Shielding A	
			Satine <i>Watts/ft</i>	LPW
835LO	3500K	400	5.4	73.7
835	3500K	600	8.3	72.2
835HO	3500K	850	12.0	70.8
835VHO	3500K	1250	18.9	66.3
840LO	4000K	400	5.3	75.7
840	4000K	600	8.1	74.1
840HO	4000K	850	11.9	71.7
840VHO	4000K	1250	18.4	68.1

¹LPW and watts/ft based off 96" fixture size.

Length

- All individual units cannot be joined, end caps are factory installed and cannot be removed
- Add 3/8" for each end cap or 3/4" to the overall length of the row
- Aperture sizes vary, 4' fixtures have a single 45-7/16" long aperture, 6' fixtures have two 33-11/16" long apertures, and 8' fixtures have two 45-7/16" long apertures

4	6	8	—
Individual Fixture	Individual Fixture	Individual Fixture	Continuous Run
48" (1,219mm)	72" (1,829mm)	96" (2,438mm)	<i>Continuous rows available in 2' increments, starting at 4'</i>
Specify to the 2', starting at 4'			

Mounting

- Specify cable length in ordering code (AC48G1)
- Standard adjustable cable. Specify 48", 120", 240" or 350"
- Adjustable aircraft cable mounts on 4'-0" (1,219mm), 6'-0" (1,829mm) or 8'-0" (3438.4mm) center
- End caps and standard white power cord attached at factory
- Aircraft Cable supplied with 5" (127mm) power and 2" (51mm) non-power canopies
- Canopies match fixture finish, power cords are white, grey, or black depending on fixture finish. See Finish section for additional details.
- Approved for dry/damp location unless otherwise noted
- Refer to installation instructions during installation at the job site
- Maximum fixture weight is 17 lbs. per 4' fixture

AC_G1	Adjustable AC to 1" (15/16") T-Bar
AC_G9	Adjustable AC to 9/16" T-Bar
AC_GS	Adjustable AC to Screw Slot T-Bar
AC_JB	Adjustable AC to Junction Box
AC_ST	Adjustable AC to Structure
AC5_G	5" (127mm) Non-Power Canopy
AC5_JB	5" (127mm) Non-Power Canopy
SQ_G	5" (127mm) Square Canopy
SQ_JB	5" (127mm) Square Canopy
WA	Wall Mount

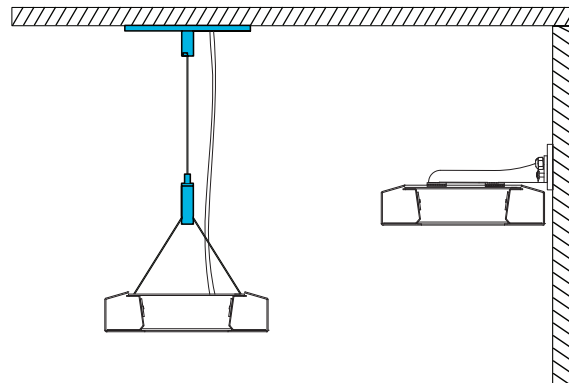

Specifications and dimensions subject to change without notice. Specification sheets that appear on pinnacle-ltg.com are the most recent version and supersede all other previously printed or electronic versions.

Designed in Denver, CO • USA | pinnacle-ltg.com | O: 303-322-5570 F: 303-322-5568

L6DI_LED_SPEC_JUNE2022



Voltage

- Some Linero configurations will not accommodate all voltage options; consult with factory

U	Universal
1	120 volt
2	277 volt
3	347 volt

Driver

- Standard Driver Option = FSD
- Driver Lifetime: 50,000 hours at 25°C ambient operating conditions
- For more driver options see Pinnacle Resource Guide
- Some LINERO configurations will not accommodate all driver options; consult with factory

0-10V Drivers	
FSD	Factory Select Driver (1%, 0-10v)
PL2	Signify Advance Xitanium 1%, 0-10v
PL4	Advance Xitanium 347v 1%, 0-10v, requires 347v
OL2	Osram Optotronic, 1%, 0-10v
OL4	Osram Optotronic 347v, 1% 0-10v, requires 347v option
EE1	eldoLED ECOdrive 1%, 0-10v Logarithmic
EE2	eldoLED ECOdrive 1%, 0-10v Linear
ES1	eldoLED SOLOdrive 0-10v, 0% Logarithmic
ES2	eldoLED SOLOdrive 0-10v, 0% Linear
OL5	Osram Optotronic 1%, 0-10v, AUX
DALI Drivers	
EE3	eldoLED SOLOdrive .1%, DALI (logarithmic)
EE4	eldoLED SOLOdrive .1%, DALI (linear)
OD1	Osram Optotronic 1%, DEXAL
OD2	Osram Optotronic 1%, DALI 2 Channel
Lutron Drivers	
LH1	Lutron Hi-lume Soft-on, Fade-to-black 1%, EcoSystem, LDE1
LH4	Lutron Hi-Lume 1%, 2-wire, Lutron-LTEA2W, 120v only
Alternate Drivers	
PS1	Signify Advance Xitanium Step Dimming 50%/100%
PR1	Philips Advance Xitanium SR, requires EASYS, VDO or VRF
OD1	Osram Optotronic 1%, DEXAL
EH1	ELV 120v only, 0-10v universal

How to specify Circuiting, Battery and Emergency

- 1**
- Select fixture circuiting from options below
 - Some LINERO configurations will not accommodate all circuiting options, consult with factory

Circuiting

1	Single Circuit
M	Multi Circuit
E	Emergency Circuit only
N	Night Light Circuit only

- 2** + **3**
- Battery and emergency section options are available in addition to fixture circuit
 - Select battery and emergency section options below; factory shop drawing required
 - Some LINERO configurations will not accommodate all circuiting options, consult with factory

Battery and/or Emergency If Required

0 No battery or specific emergency section required

Battery

- Select battery section type if required, indicate total QTY. *Example 2PL*
- 90 minute battery runtime; test button is integral to fixture
- For more battery options available, see Pinnacle Resource Guide

0	No Battery
_ILL	Iota 10w Integral Lithium, Self Testing
_IRC	Iota 10w Remote
_PLL	Bodine 10w Integral Lithium, Self Testing
_PRH	Bodine 20w Remote

For Approximate Battery Lumen Output

- Multiply battery wattage X fixture LPW shown on Lumen Table
- 92.3 (LPW) x 10 (watts) = 923 battery lumen output

Specifications and dimensions subject to change without notice. Specification sheets that appear on pinnacle-ltg.com are the most recent version and supersede all other previously printed or electronic versions.



Emergency

- Select emergency section type if required, indicate total QTY. *Example 1E*
- Combine battery and emergency section ordering codes if both options are selected

_FSG	Factory Select ALCR, Automatic Load Control Relay
_GI	Iota ETS DR, Emergency Lighting Control Device
_GB	Bodine GTD, Emergency Lighting Control Device
_E	Emergency circuit section
_N	Night Light circuit section
_L	Life Safety circuit section NO THROUGH WIRE

Combination Section Ordering Examples

- Single circuit, (1) 10w battery, (1) emergency section
Ordering Code: 1-1PL1E
- Multi circuit, (2) 10w battery, (2) emergency sections
Ordering Code: M-2PL2E
- Single circuit, (1) night light section
Ordering Code: 1-1N

Battery OR Emergency Ordering Examples

- Single circuit, 10w Integral Battery Ordering Code: 1-1PL
- Emergency only, 10w Integral Battery Ordering Code: E-1PL
- Single circuit, GTD required Ordering Code: 1-1G

Finish

- Standard powder-coat textured white, metallic silver, textured black, graphite or bronze painted finish; consult factory for chip of standard paint finishes
- Selecting a fixture finish other than white may impact lumen output; consult factory for more information

W	White (<i>white cord/white canopy</i>)
S	Metallic Silver (<i>grey cord/silver canopy</i>)
BL	Textured Black (<i>black cord/black canopy</i>)
BR	Bronze (<i>white cord/bronze canopy</i>)
GR	Graphite (<i>white cord/graphite canopy</i>)
CC	Custom Color (<i>white cord/color match canopy</i>)

Fixture Options

- Additional options to enhance the fixture and finish of the product

QS	Quick Ship
DSP	Customer Supplied Battery/Driver/Sensor

Quick Ship

Distribution	CRI, CCT & Output	Mounting	Voltage	Driver	Circuiting	Battery	Finish	
10-Day								
40	40% Direct	80 CRI, All color temperatures, all lumen packages including custom <i>See pg 2-3</i>	AC__GX Grid AC__JB Junction Box AC__ST Structure	U Universal <i>(120 thru 277)</i> 1 120 V 2 277V	FSD Factory Select Driver <i>(1%, 0-10v)</i> PL2 Advance Xitanium 0-10v, 1% LH1 Lutron LDE1 OL2 Osram 0-10v, 1%	1 Single Circuit E Emergency N Night Light	1PL Bodine 10w Integral <i>(low profile)</i>	W White
70	70% Direct							
100	100% Direct							

All lengths and continuous rows up to 1,000 ft OR 150 individual fixtures. Consult factory for larger projects.

Controls

- Pinnacle Lighting offers easy to specify network control solutions that connect to an intelligent centralized system to maximize lighting energy efficiencies or integral sensors for individual fixture control
- Pinnacle Lighting fixtures ship technology ready; commissioning by others
- Controls can only be used with Single Circuit (1) or Emergency Circuit (E)
- Contact factory for any non-standard configurations for layout, placement, or EM options
- One drop per sensor typical, consult factory for more information

	Solution	Components	Network/Sensor	Connection	Required Drivers	Limitations
DLMFC	Legrand Wattstopper DLM	LMFC-011	Digital Lighting Management (DLM)	Wired, one RJ45 ports	OL2, OL4	Not available with Battery
EASYS	Philips EasySense	SNS-210	Daylight/PIR Occupancy	Wireless to switches	PR1	Not available with 347 volt
SNSLM	Encelium Sensilum	EN-CLM-PIR-DD-ZB	Encelium, Daylight/PIR Occupancy	Wireless	OD1, OL5	Not available with 347 volt
WLWX	Eaton WaveLinx	SWPDI, MSP3IVMVDC1	WaveLinx WCL, Daylight	Wireless	Any 0-10v	Not available with 347 volt
VDO	Lutron Vive Sensor	DFCSJ-OEM-OCC	Vive, Daylight/PIR Occupancy	Wireless	OD1, PR1	Not available with 347 volt
VRF	Lutron Vive Connected	DFCSJ-OEM-RF	Vive	Wireless	OD1, PR1	Not available with 347 volt
ENLI	Enlighted IOT	SU-5E-IOT, CU-4E	Enlighted, Daylight/PIR Occupancy	Wireless	Any 0-10v	Not available with 347 volt
ENLC	Enlighted Connected Lighting	SU-5E-CL, CU-4E	Enlighted, Daylight/PIR Occupancy	Wireless	Any 0-10v	Not available with 347 volt

Specifications and dimensions subject to change without notice. Specification sheets that appear on pinnacle-ltg.com are the most recent version and supersede all other previously printed or electronic versions.

Designed in Denver, CO • USA | pinnacle-ltg.com | O: 303-322-5570 F: 303-322-5568

L6DI_LED_SPEC_JUNE2022



Photometrics

Satine

Satine

Satine

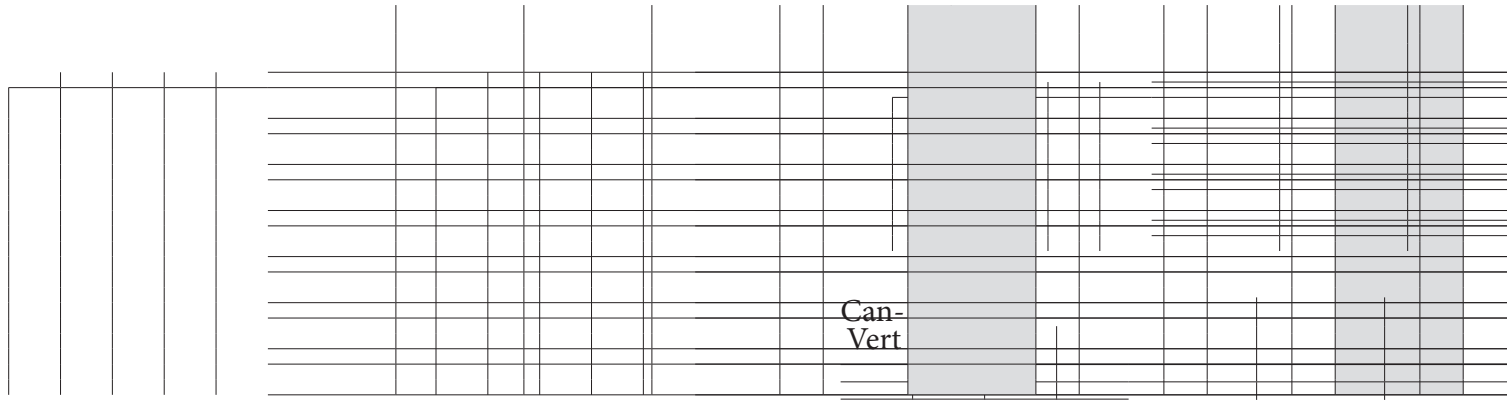
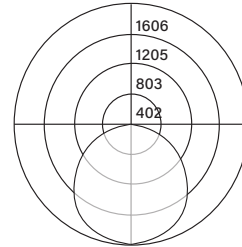
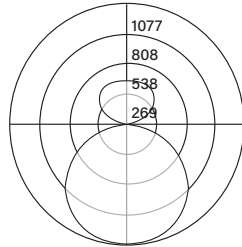
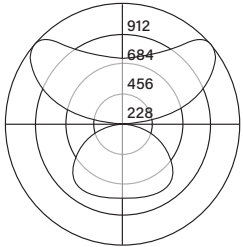
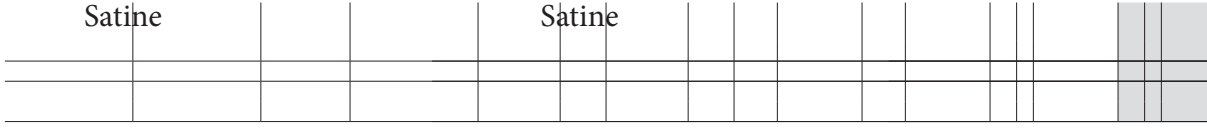

Can-Vert

Can-Vert

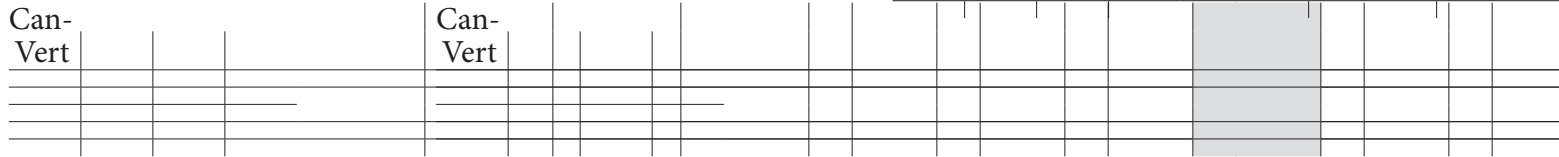

For all available IES files, please visit our website at pinnacle-ltg.com. Photometry testing in accordance to IESNA-LM-79-08 at an NVLAP accredited testing laboratory. Testing conducted at 25°C ambient conditions



Approvals & Certifications

Construction: One piece die-formed 18 gauge steel housing in a 6-7/8" (174mm) by 1-11/16" (42mm) profile with a 1-3/8" (34mm) side profile. Standard 4'-0" (1,219mm), 6'-0" (1,828mm) and 8'-0" (3,438mm) fixtures can be joined to create continuous runs. Standard high reflectance die-formed white painted aluminum.

Shielding: Direct: white satine lens with matte finish. Indirect: 40/60 distribution uses a batwing diffuser, 70/30 distribution uses a perforated reflector and clear dust guard, 100 direct distribution uses a steel top cover. 4' fixtures have a single 45-7/16" long aperture, 6' fixtures have two 33-11/16" long apertures, and 8' fixtures have two 45-7/16" long apertures.

Mounting: Adjustable aircraft cable, or wall mounts available. Air Craft Cable mounts on 4'-0" (1,219mm), 6'-0" (1,828mm) and 8'-0" (3,438mm) centers. Refer to installation instructions for appropriate ceiling detail. Maximum fixture weight is 17 lbs. per 4' fixture.

LED: 25°C test environment. Lumen output/wattage has a margin of +/- 5%. All luminaire configurations tested in accordance with IES LM-79. Diodes tested in accordance with IES LM-80. Lifetime calculated using IES TM-21. Minimum lifetime greater than 60,000 hours. Lifetime Projection for 40%, 70% and 100%: L70 lifetime - 130,000 hours and L90 lifetime - 39,000 hours. MacAdam 3-Step Ellipses. For all available IES files, please visit our website at pinnacle-ltg.com.

BIOS LED: Spectrum focused lighting for circadian stimulus. EML or M/P ratio: .8 for 3500K, .9 for 4000K. COI >3.0. Not all lumen packages available. Two lumen packages available. Standard, and High (HO). Custom outputs are available. Specify custom lumens or watts between standard offering listed on CRI, CCT & Output page.

CRI, CCT & Lumen Output: Two lumen packages available. Standard and High (HO). Custom outputs are available. Specify custom lumens or watts between standard offering listed on CRI, CCT & Output page. 80 CRI is available for 3000K, 3500K, and 4000K. 90 CRI is available for 2700K, 3000K, 3500K, and 4000K. 80 CRI = R9≥19 and 90 CRI = R9≥61. Fixture performance and photometric data based on 8' configuration for worst case input voltage. Published lumen or wattage data based on OL1 configuration.

Voltage: Universal (U), 120 volt (1), 277 volt (2) and 347 volt (3) options available. Must specify OL4 in Driver section when 347 volt (3) is selected. Some LINERO configurations will not accommodate all voltage options; consult with factory.

Driver: Standard Driver Option is Advance Xitanium 0-10V, 1% = PL2. Electronic driver, Power factor is >0.9 with a THD <20%. Driver Lifetime: 50,000 hours at 25°C ambient operating conditions. Ambient operating range for 40%, 70% and 100%: -23F/-30C to 125F/52C For more driver options, see Pinnacle Resource Guide. Some LINERO configura-

tions will not accommodate all driver options.

Circuiting: Select from single circuit (1), Multi circuit (M), Emergency circuit (E), Night Light circuit (N) or Life Safety (L). For emergency circuiting situations that require no through wire or circuit separation, Life Safety Circuit should be selected. This will provide a separate power feed and only the Life Safety Circuit in that section. Some LINERO configurations will not accommodate all circuiting options; consult with factory.

Battery & Emergency: Select battery or emergency options if required. If battery or emergency option is not required, enter 0. Battery duration is 90 minutes as standard. Test button is integral to fixture. For more Battery options, see Pinnacle Resource Guide.

Finish: Standard powder-coat textured white, metallic silver, textured black, graphite or bronze painted finish, consult factory for chip of standard paint finishes. Canopies painted white unless specified differently in the options section of the part number. Contact factory for additional custom color and finish options.

Controls: DLM utilizes wired network connections for digital control through switching and dimming with 0-10v LED drivers. nLight Air rIO module provides wireless control using eldoLED LED drivers. nLight Air rES7 sensor provides wireless control, daylight harvesting and occupancy detection with PIR or PDT using eldoLED LED drivers. EasySense sensor provides daylight harvesting and PIR occupancy detection using the SR driver; the Philips app provides advanced configurations. ENCELIUM SensiLUM sensor provides wireless control, daylight harvesting and PIR occupancy; driver data is available when using the DEXAL LED driver. WaveLinx Connected Lighting sensor provides wireless control and daylight harvesting using 0-10V LED drivers. Lutron Vive sensor provides wireless control, daylight harvesting and PIR occupancy detection using DEXAL or SR LED drivers. Lutron Vive module provides wireless control using DEXAL or SR LED drivers. Enlighted Smart Sensor provides multi-functionality including daylight harvesting and PIR occupancy; for IOT platform using 0-10v LED drivers. Enlighted Smart Sensor provides multi-functionality including daylight harvesting and PIR occupancy; for Connected platform using 0-10v LED drivers.

Labels: UL and cUL Listed. Approved for dry/damp location unless otherwise noted.

Fixture Weight: Maximum fixture weight is 17 lbs (per 4' fixture).

Buy American Act Compliant

Warranty: LINERO LED offered with a 5-year limited warranty. Covers LED, driver and fixture.