

# EDGE EX1B

## 1" Suspended Bidirectional Linear

### Key Features

- 6063-T5 Extruded aluminum housing
- Highly reflective die-formed white painted reflector
- 5-year limited warranty covers LED, driver and fixture
- UL and cUL listed
- Approved for dry/damp location unless otherwise noted
- Maximum fixture weight is 12 lbs for a standard 4' fixture
- Room-Side Maintenance for LED system
- Buy American Act compliant



Example Part #: EX1B-HE-HE-830HO-830-26'-AC48G1-U-OL1-1-0-W

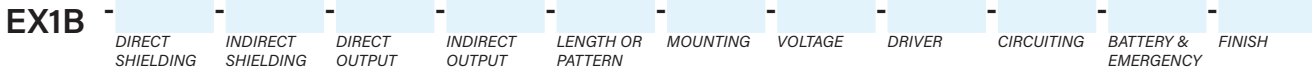

DIRECT SHIELDING	INDIRECT SHIELDING	DIRECT SOURCE <sup>1</sup>	INDIRECT SOURCE <sup>1</sup>
<b>A</b> - Satine Lens <b>HE</b> - High Efficiency Lens <b>BW</b> - Batwing Insert <b>WHE</b> - Asymmetric Insert <b>HED</b> - Descent Lens <b>P</b> - Parabolic Louver <i>Shielding pg. 2</i>	<b>HE</b> - High Efficiency <b>BW</b> - Batwing Lens <b>WHE</b> - Asymmetric Lens <b>HEA</b> - Ascent Lens <i>Shielding pg. 2</i>	<b>_27_</b> - 2700K <b>_30_</b> - 3000K <b>_35_</b> - 3500K <b>_40_</b> - 4000K <b>CL</b> - Custom Lumens <b>CW</b> - Custom Watts <b>MOD</b> - Mod options available <i>Lumen Output pg. 2-3</i>	<b>_27_</b> - 2700K <b>_30_</b> - 3000K <b>_35_</b> - 3500K <b>_40_</b> - 4000K <b>CL</b> - Custom Lumens <b>CW</b> - Custom Watts <b>MOD</b> - Mod options available <i>Lumen Output pg. 2-3</i>
LENGTH OR PATTERN <sup>2</sup>	MOUNTING <sup>3</sup>	VOLTAGE	DRIVER
<b>_</b> - Individual Fixture <b>_</b> - Continuous Row <b>L_x_x</b> - L-Shape <b>R_x_x</b> - Rectangle <b>S_</b> - Square <b>U_x_x_x</b> - U-Shape <b>T_x_x</b> - T-Shape <b>X_x_x</b> - X-Shape <b>MOD</b> - Mod options available <i>Length and Pattern pg. 3</i>	<b>AC_G</b> - AC to Grid <b>AC_JB</b> - AC to J Box <b>AC_ST</b> - AC to Structure <b>WA</b> - Wall Mount <b>AC5_G</b> - 5" Non-Power Canopy <b>AC5_JB</b> - 5" Non-Power Canopy <b>SQ_G</b> - 5" Square Canopy <b>SQ_JB</b> - 5" Square Canopy <i>Mounting pg. 4</i>	<b>U</b> - Universal (120 thru 277V) <b>1</b> - 120V <b>2</b> - 277V <b>3</b> - 347V <i>Voltage pg. 4</i>	<b>FSD</b> - Factory Select Driver (1%, 0-10v) <b>PL2</b> - Advance Xitanium (1%, 0-10v) <b>OL4</b> - Osram 347v (1%, 0-10v) <b>EE1</b> - eldoLED ECOdrive (1%, 0-10v) <b>ES1</b> - eldoLED SOLOdrive (0%, 0-10v) <b>LH1</b> - Lutron Hi-lume (1%, EcoSystem) <b>PS1</b> - Advance Xitanium (50%/100%) <b>OL2</b> - Osram (1%, 0-10v) <b>ND</b> - Non-Dimming <i>Driver pg. 4</i>
CIRCUITING	BATTERY & EMERGENCY <sup>4</sup>	FINISH	CONTROLS
<b>1</b> - Single Circuit <b>2</b> - Dual Circuit (direct/indirect) <b>M</b> - Multi Circuit <b>E</b> - Emergency (entire fixture) <b>N</b> - Night Light (entire fixture) <i>Circuiting pg. 5</i>	<b>0</b> - None <b>FSG</b> - Factory Select ALCR <b>GI</b> - Iota ETS DR <b>GB</b> - Bodine GTD <b>PLL</b> - Bodine 10W (low profile) <b>ILL</b> - Iota 10w Integral <b>E</b> - Emergency Section <b>N</b> - Night Light Section <b>L</b> - Life Safety Section <i>Battery and Emergency pg. 5</i>	<b>W</b> - White <b>S</b> - Metallic Silver <b>BL</b> - Textured Black <b>BR</b> - Bronze <b>GR</b> - Graphite <b>CC</b> - Custom Color <i>Finish pg. 5</i>	<i>Pinnacle is able to accommodate different control solutions from different manufacturers. Consult Factory for more information.</i>

<sup>1</sup>When specifying CRI, CCT & OUTPUT the first \_ is for specifying either **8** - 80CRI or **9** - 90CRI. The ending \_\_ are for specifying output, example **HO** - High Output. See output charts for more information. <sup>2</sup>Individual fixtures come in 2', 3', 4', 5', 6', 7', & 8' lengths. Continuous row come in 1' increments. For Mod layouts Specify pattern shape and overall dimensions. Example: L6x4: L pattern that is 6'x4'. <sup>3</sup>Specify AC length standard AC is 48"; Specify grid: G1=15/16", G9=9/16", GS=Screw Slot. Example: AC48G1 \*Enter quantity for Battery and Emergency, Example 2PL.

Specifications and dimensions subject to change without notice. Specification sheets that appear on pinnacle-ltg.com are the most recent version and supersede all other previously printed or electronic versions.



Direct Shielding

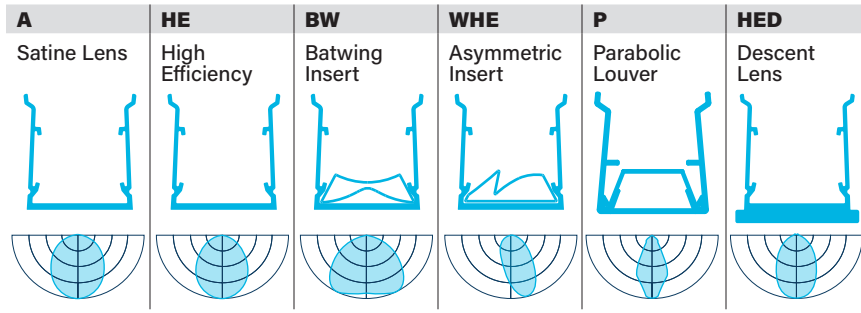

Indirect Shielding

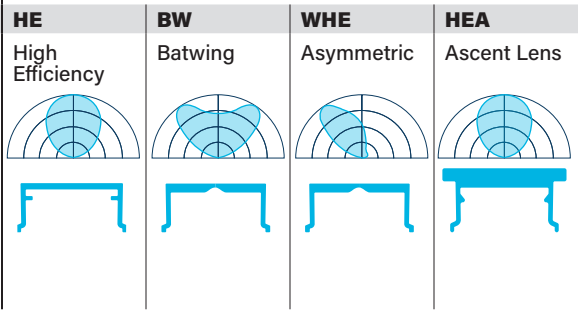

CRI, CCT & Output

- Specify either 80 or 90 CRI
- Longer lead-time may apply for 90 CRI. Consult factory.
- 80 CRI = R9≥19 and 90 CRI = R9≥61

Custom Output - Lumens OR Wattage

**CL** \_\_\_\_\_ Specify CRI, CCT and desired lumens (i.e. CL835600) *Specify lumens between standard offering listed below. Lumens are specified per color temp*  
**CW** \_\_\_\_\_ Specify CRI, CCT and desired wattage (i.e. CW9407) *Specify lumens between standard offering listed below. Lumens are specified per color temp*

Direct 80 CRI

	Color	Output	Watts per foot	Shielding											
				A Satine Lens		HE High Efficiency		BW Batwing		WHE Asymmetric		P Louver		HED Descent	
				Lumens/ft	LPW	Lumens/ft	LPW	Lumens/ft	LPW	Lumens/ft	LPW	Lumens/ft	LPW	Lumens/ft	LPW
<b>830</b>	3000K	Standard	4.5	347	77.1	412	91.6	327	72.7	365	81.1	273	60.7	377	83.8
<b>830HO</b>	3000K	High	8.6	641	74.5	761	88.5	604	70.2	676	78.6	504	58.6	698	81.2
<b>835</b>	3500K	Standard	4.5	357	79.3	424	94.2	336	74.7	376	83.6	281	62.4	388	86.2
<b>835HO</b>	3500K	High	8.6	658	76.6	782	90.9	621	72.2	695	80.8	519	60.3	717	83.4
<b>840</b>	4000K	Standard	4.5	365	81.0	432	96.0	343	76.2	383	85.1	286	63.6	396	88.0
<b>840HO</b>	4000K	High	8.6	670	77.8	797	92.7	633	73.6	708	82.3	529	61.5	731	85.0

Direct 90 CRI

<b>927</b>	2700K	Standard	4.5	274	60.8	325	72.2	259	57.6	289	64.2	216	48.0	298	66.2
<b>927HO</b>	2700K	High	8.6	506	58.8	601	69.9	478	55.6	534	62.1	399	46.4	551	64.1
<b>930</b>	3000K	Standard	4.5	320	71.1	380	84.4	302	67.1	337	74.9	252	56.0	348	77.3
<b>930HO</b>	3000K	High	8.6	591	68.7	701	81.5	557	64.8	623	72.4	465	54.1	643	74.8
<b>935</b>	3500K	Standard	4.5	321	71.3	382	84.9	303	67.3	339	75.3	253	56.2	349	77.6
<b>935HO</b>	3500K	High	8.6	592	68.8	704	81.9	559	65.0	625	72.7	467	54.3	645	75.0
<b>940</b>	4000K	Standard	4.5	326	72.4	386	85.8	306	68.0	342	76.0	256	56.9	354	78.7
<b>940HO</b>	4000K	High	8.6	598	69.5	711	82.7	565	65.7	632	73.5	472	54.9	653	75.9

Indirect 80 CRI

	Color	Output	Watts per foot	Shielding									
				HE High Efficiency		BW Batwing		WHE Asymmetric		HEA Ascent			
				Lumens/ft	LPW	Lumens/ft	LPW	Lumens/ft	LPW	Lumens/ft	LPW		
<b>830</b>	3000K	Standard	4.5	456	101.3	449	99.8	268	59.6	447	99.3		
<b>830HO</b>	3000K	High	8.6	834	97.0	831	96.6	495	57.6	826	96.0		
<b>835</b>	3500K	Standard	4.5	469	104.2	462	102.7	276	61.3	460	102.2		
<b>835HO</b>	3500K	High	8.6	858	99.8	854	99.3	509	59.2	850	98.8		
<b>840</b>	4000K	Standard	4.5	478	106.2	471	104.7	281	62.4	467	103.8		
<b>840HO</b>	4000K	High	8.6	875	101.7	871	101.3	519	60.3	866	100.7		

Indirect 90 CRI

<b>927</b>	2700K	Standard	4.5	360	80.0	355	78.9	212	47.1	354	78.7		
<b>927HO</b>	2700K	High	8.6	659	76.6	657	76.4	391	45.5	653	75.9		
<b>930</b>	3000K	Standard	4.5	420	93.3	414	92.0	247	54.9	412	91.6		
<b>930HO</b>	3000K	High	8.6	769	89.4	766	89.1	456	53.0	761	88.5		
<b>935</b>	3500K	Standard	4.5	422	93.8	416	92.4	249	55.3	414	92.0		
<b>935HO</b>	3500K	High	8.6	772	89.8	768	89.3	458	53.3	765	89.0		
<b>940</b>	4000K	Standard	4.5	427	94.9	421	93.6	251	55.8	417	92.7		
<b>940HO</b>	4000K	High	8.6	781	90.8	777	90.3	463	53.8	773	89.9		

Specifications and dimensions subject to change without notice. Specification sheets that appear on pinnacle-ltg.com are the most recent version and supersede all other previously printed or electronic versions.



**Source: MOD Options**

- Specify **MOD** in the part number for any of the below options
- All RGB\_ Source Options will require specific driver and control

- Consult factory for **MOD** specification details, pricing, and lead-time information

**MOD** TIR Optics

Required Driver | Required Control

**Length**

- All individual units cannot be joined, end plates are factory installed and cannot be removed
- For Continuous runs, add 1/4" (6.4mm) for each end plate or 1/2" (12.7mm) to the overall length of the row
- For patterns, refer to Pattern section on next page

2	3	4	5	6	7	8	-
Indiv. Fixture	Indiv. Fixture	Indiv. Fixture	Indiv. Fixture	Indiv. Fixture	Indiv. Fixture	Indiv. Fixture	Cont. Run Specify nominal overall row length to the 1'
24" (609.6mm)	36" (914.4mm)	48" (1219.2mm)	60" (1524mm)	72" (1828.8mm)	84" (2133.6mm)	96" (2438.4mm)	
							Specify to the 1' >>>

**Pattern**

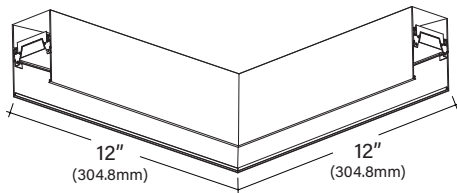

- Specify pattern shape and overall dimensions (includes corner dimensions)
- Refer to dimensions table below for available standard lengths
- All connectors are direct only
- 90 degree horizontal corners are 12"x12" (overall, outside dimension)
- Angles and shapes not shown require Mod Pattern; consult factory
- Only available with HE lens

S_	R_x_	U_x_x_	L_x_	T_x_	X_x_
Square Provide A dimension Example: <b>S4'</b> Minimum Length- 4'x4'	Rectangle Provide AxB dimensions Example: <b>R4'x4'</b> Minimum Length- 4'x4'	U-Shape Provide AxBxC dimensions Example: <b>U3'x4'x3'</b> Minimum Length- 3'x4'x3'	L-Shape Provide AxB dimensions Example: <b>L3'x3'</b> Minimum Length- 3'x3'	T-Shape Provide AxB dimensions Example: <b>T3'x5'</b> Minimum Length- 3'x5'	X-Shape Provide AxB dimensions Example: <b>X5'x5'</b> Minimum Length- 5'x5'

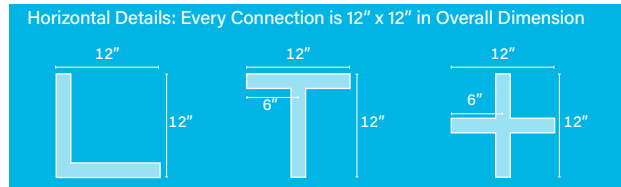
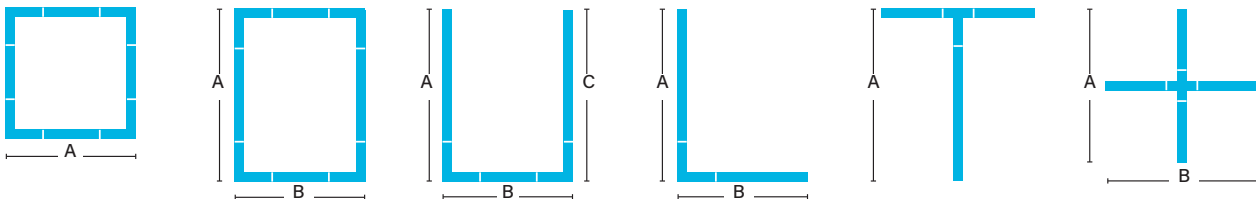

**Length or Pattern: MOD Options**

- Specify **MOD** in the part number for any of the below options
- Consult factory for **MOD** specification details, pricing, and lead-time information

<b>MOD</b>	Specify MOD for patterns, lengths or angles not shown above
	45- 180 degree angles
	Single-piece welded housings up to 4' x 4

Specifications and dimensions subject to change without notice. Specification sheets that appear on pinnacle-ltg.com are the most recent version and supersede all other previously printed or electronic versions.



## Mounting

- Specify cable length in ordering code (AC48G1)
- Standard adjustable cable. Specify 48", 120", 240" or 350"
- End plates and power cord attached at factory
- Aircraft cable (AC) mounts on 4" (1219.2mm) and 8" (2438.4mm) centers
- Aircraft Cable supplied with 5" (127mm) power and 2" (50.8mm) non-power canopies

<b>AC_G1</b>	Aircraft Cable to 1" (15/16") T-Bar
<b>AC_G9</b>	Aircraft Cable to 9/16" T-Bar
<b>AC_GS</b>	Aircraft Cable to Screw Slot T-Bar
<b>AC_JB</b>	Aircraft Cable to Junction Box
<b>AC_ST</b>	Aircraft Cable to Structure
<b>AC5_G</b>	5" (127mm) Non-Power Canopy
<b>AC5_JB</b>	5" (127mm) Non-Power Canopy
<b>SQ_G</b>	5" (127mm) Square Canopy
<b>SQ_JB</b>	5" (127mm) Square Canopy
<b>WA</b>	Wall Mount (ADA Compliant, 1/2" off the wall)

- Canopies and pendants match fixture finish, power cords are white, grey, or black depending on fixture finish. See Finish section for additional details.
- Approved for dry/damp location unless otherwise noted
- Refer to installation instructions during installation at the job site
- Maximum fixture weight is 12 lbs for a standard 4' fixture
- For a wall mounted fixture with an indirect asymmetric lens, light will be directed away from the wall as a standard

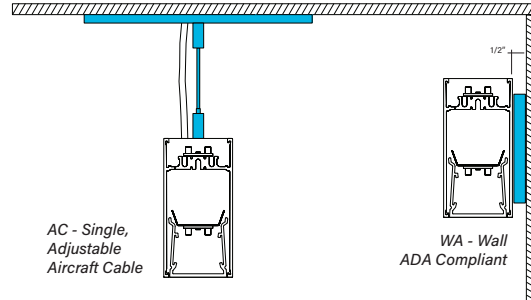

## Voltage

- Some EX1B configurations will not accommodate all voltage options; consult with factory

<b>U</b>	Universal
<b>1</b>	120 volt
<b>2</b>	277 volt
<b>3</b>	347 volt

## Driver

- Standard Driver Option = FSD
- Driver Lifetime: 50,000 hours at 25°C ambient operating conditions
- For more driver options, see Pinnacle Resource Guide

- Some EX1B configurations will not accommodate all driver options; consult with factory

### 0-10V Drivers

<b>FSD</b>	Factory Select Driver 1%, 0-10v
<b>PL2</b>	Signify Advance Xitanium 1%, 0-10v
<b>PL4</b>	Advance Xitanium 347v 1%, 0-10v, requires 347v
<b>OL2</b>	Osram Optotronic, 1%, 0-10v
<b>OL4</b>	Osram Optotronic 347v, 1% 0-10v, requires 347v option
<b>EE1</b>	eldoLED ECOdrive 1%, 0-10v Logarithmic
<b>EE2</b>	eldoLED ECOdrive 1%, 0-10v Linear
<b>ES1</b>	eldoLED SOLOdrive 0-10v, 0% Logarithmic
<b>ES2</b>	eldoLED SOLOdrive 0-10v, 0% Linear

### DALI Drivers

<b>EE3</b>	eldoLED SOLOdrive .1%, DALI (logarithmic)
<b>EE4</b>	eldoLED SOLOdrive .1%, DALI (linear)
<b>OD1</b>	Osram Optotronic 1%, DEXAL
<b>OD2</b>	Osram Optotronic 1%, DALI 2 Channel

### Lutron Drivers

<b>LH1</b>	Lutron Hi-lume Soft-on, Fade-to-black 1%, EcoSystem, LDE1
<b>LH4</b>	Lutron Hi-Lume 1%, 2-wire, Lutron-LTEA2W, 120v only

### Alternate Drivers

<b>PS1</b>	Signify Advance Xitanium Step Dimming 50%/100%
------------	--



## How to specify Circuiting, Battery and Emergency

- 1**
- Select fixture circuiting from options below
  - Some EX1B configurations will not accommodate all circuiting options, consult with factory

### Circuiting

<b>1</b>	Single Circuit
<b>2</b>	Dual Circuit ( <i>direct/indirect</i> )
<b>M</b>	Multi Circuit
<b>E</b>	Emergency Circuit only
<b>N</b>	Night Light Circuit only

- 2** + **3**
- Battery and emergency section options are available in addition to fixture circuit
  - Select battery and emergency section options below; factory shop drawing required
  - Some EX1B configurations will not accommodate all circuiting options, consult with factory

### Battery and/or Emergency If Required

- 0** No battery or specific emergency section required

### Battery

- Select battery section type if required, indicate total QTY. *Example 2PL*
- 90 minute battery runtime; test button is remote to fixture and requires an additional drop
- Battery not available for lengths under 4'
- Entire direct fixture housing is on battery for lengths up to 5'
- Half of direct fixture is on battery for 6', 7' or 8' housing lengths
- For more battery options available, see Pinnacle Resource Guide

#### For Approximate Battery Lumen Output

- Multiply battery wattage X fixture LPW shown on Lumen Table
- $92.3 \text{ (LPW)} \times 10 \text{ (watts)} = 923 \text{ battery lumen output}$

<b>0</b>	No Battery
<b>_ILL</b>	Iota 10w Integral Lithium, Self Testing
<b>_IRH</b>	Iota 20w Remote
<b>_PLL</b>	Bodine 10w Integral Lithium, Self Testing
<b>_PRH</b>	Bodine 20w Remote

### Emergency

- Select emergency section type if required, indicate total QTY. *Example 1E*
- Combine battery and emergency section ordering codes if both options are selected

<b>_FSG</b>	Factory Select ALCR, Automatic Load Control Relay
<b>_GI</b>	Iota ETS DR, Emergency Lighting Control Device
<b>_GB</b>	Bodine GTD, Emergency Lighting Control Device
<b>_E</b>	Emergency circuit section
<b>_N</b>	Night Light circuit section
<b>_L</b>	Life Safety circuit section NO THROUGH WIRE

#### Battery OR Emergency Ordering Examples

- |  |                      |
|--|----------------------|
| • Single circuit, 10w Integral Battery | Ordering Code: 1-1PL |
| • Emergency only, 10w Integral Battery | Ordering Code: E-1PL |
| • Single circuit, GTD required         | Ordering Code: 1-1G  |

#### Combination Section Ordering Examples

- |  |                        |
|--|------------------------|
| • Single circuit, (1) 10w battery, (1) emergency section | Ordering Code: 1-1PL1E |
| • Multi circuit, (2) 10w battery, (2) emergency sections | Ordering Code: M-2PL2E |
| • Single circuit, (1) night light section                | Ordering Code: 1-1N    |

### Finish

- Standard powder-coat textured white, metallic silver, textured black, graphite or bronze painted finish; consult factory for chip of standard paint finishes
- Selecting a fixture finish other than white may impact lumen output; consult factory for more information

<b>W</b>	White ( <i>white cord/white canopy</i> )
<b>S</b>	Metallic Silver ( <i>grey cord/silver canopy</i> )
<b>BL</b>	Textured Black ( <i>black cord/black canopy</i> )
<b>BR</b>	Bronze ( <i>white cord/bronze canopy</i> )
<b>GR</b>	Graphite ( <i>white cord/graphite canopy</i> )
<b>CC</b>	Custom Color ( <i>white cord/color match canopy</i> )

### Controls

- Pinnacle is able to accommodate different control solutions from different manufacturers. Consult Factory for more information.



**Photometrics**

**High Efficiency - High Efficiency**

Test # ITL86990  
Catalog # EX1B-HE-HE-840-840-4  
Lumens 3474 Lm  
Watts 35.6 W  
Efficacy 98 LPW

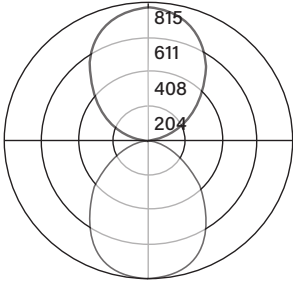

**Candela Distribution**

Vert Angle	Horizontal Angle				
	0	22.5	45	67.5	90
0	815	815	815	815	815
5	811	810	809	807	807
15	774	763	752	737	730
25	697	673	637	598	584
35	581	548	492	439	419
45	442	408	348	301	284
55	302	275	230	197	185
65	181	165	139	119	114
75	88	81	68	61	59
85	20	19	17	17	18
95	22	23	25	28	28
105	96	97	96	95	94
115	195	193	191	186	183
125	314	310	306	298	296
135	445	439	433	426	422
145	573	562	558	550	547
155	673	664	664	657	653
165	739	735	737	733	731
175	770	770	770	770	770
180	774	774	774	774	774

**Luminance Data (cd/sq.m)**

Angle In Degrees	Average 0-Deg	Average 45-Deg	Average 90-Deg
45	13452	10600	8647
55	11310	8635	6954
65	9231	7053	5808
75	7282	5673	4911
85	5029	4275	4526

**Batwing - Batwing**

Test # ITL86987/87002  
Catalog # EX1BW-BW-840-840-4  
Lumens 3255 Lm  
Watts 38.9 W  
Efficacy 84 LPW

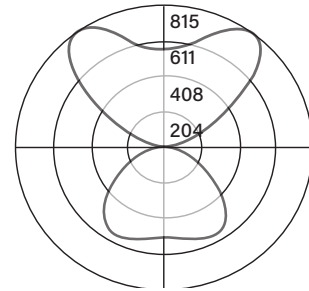

**Candela Distribution**

Vert Angle	Horizontal Angle				
	0	22.5	45	67.5	90
0	445	445	445	445	445
5	443	447	451	452	453
15	424	432	447	463	470
25	387	397	436	477	494
35	334	348	400	459	484
45	270	284	335	388	409
55	202	210	248	282	293
65	135	138	159	176	182
75	73	73	81	87	89
85	22	20	21	21	21
95	14	20	19	15	13
105	63	104	119	95	87
115	131	216	285	244	227
125	211	313	472	461	441
135	294	375	575	646	650
145	369	417	571	683	714
155	430	448	527	608	639
165	471	475	499	525	535
175	491	491	493	495	496
180	493	493	493	493	493

**Luminance Data (cd/sq.m)**

Angle In Degrees	Average 0-Deg	Average 45-Deg	Average 90-Deg
45	8387	10406	12705
55	7736	9497	11221
65	7017	8264	9459
75	6195	6874	7553
85	5545	5292	5292

**Asymmetric - Asymmetric**

Test # ITL86988/87003  
Catalog # EX1B-WHE-WHE-840-840-4  
Lumens 2655 lm  
Watts 38.9 W  
Efficacy 68 LPW

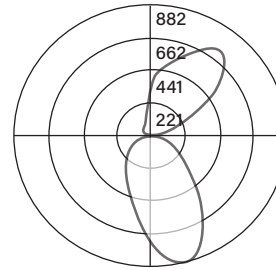

**Candela Distribution**

Vert Angle	Horizontal Angle				
	0	22.5	45	67.5	90
0	715	715	715	715	715
5	803	777	711	651	626
15	879	839	672	513	463
25	769	790	593	398	353
35	554	641	487	309	283
45	361	457	367	236	229
55	230	297	255	172	174
65	140	175	158	113	116
75	71	85	81	60	62
85	20	23	23	17	16
95	23	28	9	6	6
105	108	135	43	23	23
115	262	305	89	41	42
125	481	484	143	56	56
135	677	568	201	67	67
145	714	548	254	76	74
155	615	497	296	94	81
165	502	457	325	143	110
175	419	399	340	267	240
180	342	342	342	342	342

**Luminance Data (cd/sq.m)**

Angle In Degrees	Average 0-Deg	Average 45-Deg	Average 90-Deg
45	11214	14196	11400
55	8808	11374	9765
65	7276	9095	8212
75	6026	7214	6874
85	5040	5797	5797

For all available IES files, please visit our website at [pinnacle-ltg.com](http://pinnacle-ltg.com). Photometry testing in accordance to IESNA-LM-79-08 at an NVLAP accredited testing laboratory. Testing conducted at 25°C ambient conditions

Specifications and dimensions subject to change without notice. Specification sheets that appear on [pinnacle-ltg.com](http://pinnacle-ltg.com) are the most recent version and supersede all other previously printed or electronic versions.



## Applications & Certificates

**Construction:** 6063-T5 Extruded aluminum housing. Highly reflective die-formed white painted reflector.

**Shielding:** Diffuse snap-in acrylic lens with matte finish, removable for maintenance.

**Mounting:** Aircraft cable and wall mount available. Straight aircraft cable mounts on 4'-0" (1219.2mm) and 8'-0" (2438.4mm) centers Aircraft Cable supplied with 5" (127mm) power and 2" (50.8mm) non-power canopies. Refer to installation instructions for appropriate ceiling detail. Canopies are painted white unless otherwise specified. Maximum fixture weight is 12 lbs for a standard 4' fixture.

**LED:** 25°C test environment. Lumen output/wattage has a margin of +/- 5%; 2' or 3' lengths may have a greater wattage deviation. All luminaire configurations tested in accordance with IES LM-79. Diodes tested in accordance with IES LM-80. Lifetime calculated using IES TM-21. Minimum lifetime greater than 60,000 hours. L70 = 120,200 hours and L90 = 35,900 hours. MacAdam 3-Step Ellipses. Not all products are Lighting Facts listed. For all available IES files, please visit our website at [pinnacle-ltg.com](http://pinnacle-ltg.com).

**CRI, CCT & Lumen Output:** Two lumen packages available. Standard and High (HO). Custom outputs are available. Specify custom lumens or watts between standard offering listed on CRI, CCT & Output page. 80 CRI is available for 3000K, 3500K, and 4000K. 90 CRI is available for 2700K, 3000K, 3500K, and 4000K. 80 CRI = R9≥19 and 90 CRI = R9≥61.

**Voltage:** Universal (U), 120 volt (1), 277 volt (2) and 347 volt (3) options available. Must specify OL4 in Driver section when 347 volt (3) is selected. Some EX configurations will not accommodate all voltage options; consult with factory.

**Driver:** Standard Driver Option is Advance Xitanium 0-10V, 1% = PL2. Electronic driver, Power factor is >0.9 with a THD <20%. Driver Lifetime: 50,000 hours at 25°C ambient operating conditions. Ambient operating range: -20°F/-30°C to 103°F/40°C. For more driver

options, see Pinnacle Resource Guide. Some EX configurations will not accommodate all driver options.

**Circuiting:** Select from single circuit (1), dual circuit (2), Multi circuit (M), Emergency circuit (E) or Night Light circuit (N). For emergency circuiting situations that require no through wire or circuit separation, Life Safety Circuit should be selected. This will provide a separate power feed and only the Life Safety Circuit in that section. Some EX configurations will not accommodate all circuiting options; consult with factory.

**Battery & Emergency:** Select battery or emergency options if required. If battery or emergency option is not required, enter 0. Battery duration is 90 minutes as standard. Test button is remote to fixture. For more Battery options, see Pinnacle Resource Guide.

**Finish:** Standard powder-coat textured white, metallic silver, graphite, textured black or bronze painted finish; consult factory for chip of standard paint finishes. Canopies painted white unless specified differently in the options section of the part number. Contact factory for additional custom color and finish options.

**Controls:** Consult factory.

**Labels:** UL and cUL Listed. Standard and HO lumen packages are approved for dry/damp location unless otherwise noted.

**Fixture Weight:** Maximum fixture weight is 12 lbs for a standard 4' fixture.

**Buy American Act Compliant**

**Warranty:** EX LED offered with a 5-year limited warranty. Covers LED, driver and fixture.