

CHUTE CDSR

Open Linear Direct Suspended to Recessed

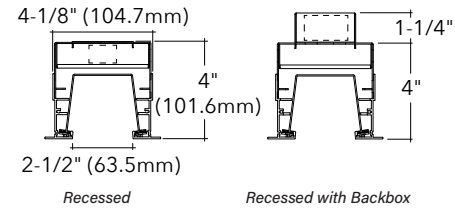

Key Features

- Suspended to Recessed open aperture fixture
- Suspended: 6063-T6 Extruded aluminum housing
- Recessed: Extruded aluminum trim with formed cold rolled 18 gauge steel housing and back box
- 4" wide suspended fixture with a 2 1/2" fully luminous aperture
- Small, integral driver option for quick, easy installation
- Light Protection Guard (LPG) covers LEDs for optimal performance
- Four distinct decorative endcaps for tailored designs on suspended end
- 5-year limited warranty covers LED, driver and fixture
- ETL listed conforming to UL 1598 in US and CSA 250 in Canada
- Buy American Act compliant



Example Part #: CDSR-N-830HO-26'-AC48G1/SF8-1-EL1-1-0-W-AT

CDSR- N

HOUSING INDIRECT SHIELDING CRI, CCT & OUTPUT LENGTH MOUNTING VOLTAGE DRIVER CIRCUITING BATTERY & EMERGENCY FINISH ENDCAPS FIXTURE OPTIONS CONTROLS

N	-----	---	----- / SF -----
INDIRECT SHIELDING	CRI, CCT & OUTPUT¹	LENGTH²	MOUNTING³
N - None	_27_ - 2700K _30_ - 3000K _35_ - 3500K _40_ - 4000K CL - Custom Lumens CW - Custom Watts <i>CRI, CCT & Output pg. 2</i>	_ - Continuous Row <i>(Specify overall length of row, this will include both recessed and suspended sections. Recessed only specified in Mounting section)</i> <i>Length pg. 2</i>	Suspended Mounting AC_G - AC to Grid AC_JB - AC to J Box AC_ST - AC to Structure Recessed Mounting SF - Spackle Flange <i>(Specify Recessed length, example 8' length is SF8)</i> <i>Mounting pg. 3</i>
VOLTAGE	DRIVER	CIRCUITING⁴	BATTERY & EMERGENCY⁵
U - Universal (120 thru 277V, remote) 1 - 120V 2 - 277V 3 - 347V (remote) <i>Voltage pg. 3</i>	Integral Driver / 4" Recessed Housing EL1 - ERP Power (1%, 0-10v, 120v or 277v) Remote Drivers / Recessed with Backbox FSD - Factory Select Driver (1%, 0-10v) PL2 - Advance Xitanium (1%, 0-10v) OL2 - Osram (1%, 0-10v) OL4 - Osram 347v (1%, 0-10v) EE1 - eldoLED ECOdrive (1%, 0-10v) ES1 - eldoLED SOLOdrive (0%, 0-10v) LH1 - Lutron Hi-lume (1%, EcoSystem) <i>Driver pg. 4</i>	1 - Single Circuit M - Multi Circuit E - Emergency (entire fixture) N - Night Light (entire fixture) <i>Circuiting pg. 4</i>	0 - None _FSG - Factory Select ALCR _GI - Iota ETS DR _GB - Bodine GTD _PLL - Bodine 10W (remote) _ILL - Iota 10W (remote) _E - Emergency Section _N - Night Light Section _L - Life Safety Section <i>Battery & Emergency pg. 5</i>
FINISH	SUSPENDED ENDCAP	FIXTURE OPTIONS	CONTROLS
W - White S - Metallic Silver BL - Textured Black BR - Bronze GR - Graphite CC - Custom Color <i>Finish pg. 5</i>	FE - Flat Endcap IB - Inward Bevel Endcap OB - Outward Bevel Endcap AT - Angled Twist Endcap <i>Endcaps pg. 5</i>	DSP - Customer Supplied Battery/Driver/Sensor CP - Chicago Plenum <i>Fixture Options pg. 5</i>	<i>Pinnacle is able to accommodate different control solutions from different manufacturers. Consult Factory for more information.</i>

¹When specifying CRI, CCT & OUTPUT the first _ is for specifying either **8** - 80CRI or **9** - 90CRI. The ending _ _ are for specifying output, example **HO** - High Output. See output charts for more information. ²Length must be specific in 1' increments. ³When specify cable length standard AC is **48'**, **120"**, or **240"**. When Specifying grid for AC _ _ G _ use one of the following: **G1**=15/16", **G9**=9/16" or **GS**=Screw Slot. Example: AC48G1. When specifying spackle flange section use the " _ " to enter the recessed length. Recessed sections can be specified in 1' increments, and will be a section from the total length specified in the length. Recessed non joined end will have closed endcap. ⁴No through wire will be provided between suspended and recessed fixtures. ⁵All Battery & Emergency options are REMOTE. Enter quantity for Battery and Emergency, Example 2P.

Specifications and dimensions subject to change without notice. Specification sheets that appear on pinnacle-ltg.com are the most recent version and supersede all other previously printed or electronic versions.



CRI, CCT & Output

- 80 CRI = R9≥5, 90 CRI = R9≥61

Custom Output - Lumens OR Wattage

CL _____	Specify CRI, CCT and desired lumens (i.e. CL835500)	<i>Specify lumens between standard offering listed below. Lumens are specified per color temp</i>
CW _____	Specify CRI, CCT and desired wattage (i.e. CW9407)	<i>Specify watts between standard offering listed below</i>

80 CRI

	Color	Output ¹		
		Lumens/ft	LPW	Watts/ft
830	3000K	500	115	4.3
830HO	3000K	750	116	6.5
830VHO	3000K	1000	116	8.6
835	3500K	500	123	4.1
835HO	3500K	750	124	6.0
835VHO	3500K	1000	125	8.0
840	4000K	500	128	3.9
840HO	4000K	750	128	5.9
840VHO	4000K	1000	128	7.8

90 CRI *(longer lead times may apply, consult factory)*

927	2700K	500	97	5.2
927HO	2700K	750	97	7.7
927VHO	2700K	1000	100	10.0
930	3000K	500	105	4.8
930HO	3000K	750	105	7.1
930VHO	3000K	1000	106	9.4
935	3500K	500	110	4.6
935HO	3500K	750	110	6.8
935VHO	3500K	1000	111	9.0
940	4000K	500	107	4.7
940HO	4000K	750	107	7.0
940VHO	4000K	1000	108	9.3

¹LPW and watts/ft based off 48" fixture size.

Length

- Length must be specified in 1' increments
- Recessed length is to the foot. Example 8' = 96"
- For Standard Flat end cap adds 5/16" (7.6mm) to the overall length of the row.
- For Inward Bevel end cap adds 13/32" (10.1mm) to the overall length of the row.
- For Outward Bevel end cap adds 23/32" (18.4mm) to the overall length of the row.
- For Angled Twist end cap adds 1/2" (12.6mm) to the overall length of the row.
- See page 4 for endcap details.
- Consult factory for additional lengths.

Continuous Run

Specify nominal overall row length. Lengths must be in 1' increments.

Specify Overall Length

Fixture lengths do not include endcap dimensions. See bullet points listed above for each endcap. Example: 2' fixture (24") + 1 Standard Flat Endcap (5/16") = 24 5/16" overall.

Length Breakdown

- Specified Length: 16' - Mounting: AC48G1/SF8 = 16' overall, 8' Suspended & 8' Recessed

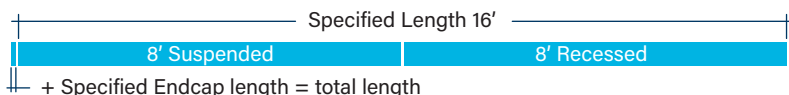



Suspended Mounting

- Specify cable length in ordering code (AC48G1)
- Standard specifiable lengths are 48", 120", 240" and 350"
- End plates and power cord attached at factory
- Aircraft cable (AC) mounts on 4' (1219.2mm) and 8' (2438.4mm) centers
- Aircraft Cable supplied with 5" (127mm) power and 2" (50.8mm) non-power canopies
- Canopies are painted to match fixture finish, power cords are white, grey, or black depending on fixture finish. See Finish section for additional details

- Approved for dry/damp location unless otherwise noted
- Refer to installation instructions during installation at the job site
- Maximum fixture weight is 20 lbs for a standard 4' fixture
- Remote box will be included for all specifications that include batteries, GTD, or a driver OTHER THAN the EL1. See Installation Instructions for more specific information about mounting
- For integral driver version, access for wiring and drivers through the indirect side of the fixture only

AC_G1	Aircraft Cable 1" (15/16") T-Bar
AC_G9	Aircraft Cable 9/16" T-Bar
AC_GS	Aircraft Cable Screw Slot T-Bar
AC_JB	Aircraft Cable Junction Box
AC_ST	Aircraft Cable Structure
AC5_G	Aircraft Cable 5" (127mm) Non-Power Canopy
AC5_JB	Aircraft Cable 5" (127mm) Non-Power Canopy
SQ_G	Aircraft Cable 5" (127mm) Square Canopy
SQ_JB	Aircraft Cable 5" (127mm) Square Canopy

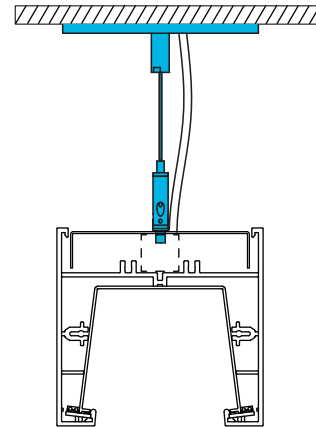

AC - Single,
Adjustable AC Cable

Recessed Mounting

- Continuous Units, specify, SF__
- Use "__" to specify recessed length in 1' increments

- Designed to install into inaccessible ceilings
- Approved for dry/damp location unless otherwise noted

SF__
Drywall,
Flangeless Detail
Flange to Flange:
6" (152.4mm)

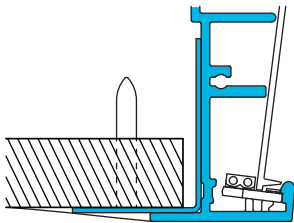

Voltage

- Some CHUTE configurations will not accommodate all voltage options; consult with factory
- For EL1 driver, must specify 120v or 277v

U	Universal (remote)
1	120 volt
2	277 volt
3	347 volt (remote)



Driver

- Standard Driver Option = EL1
- Driver Lifetime: 50,000 hours at 25°C ambient operating conditions
- For more driver options, see Pinnacle Resource Guide
- Some CHUTE configurations will not accommodate all driver options; consult with factory
- On suspended fixtures, EL1 driver is integral to the fixture housing. Remote box necessary for all drivers OTHER THAN the EL1
- On recessed fixtures, EL1 driver is in a 4" housing. Deeper 5 1/4" necessary for all drivers OTHER THAN the EL1
- Osram and Lutron Drivers have a remote distance limitation of 10'
- eldoLED and Advance Drivers have an average remote distance limitation of 50'. Consult Factory for specific configurations

Slim Remote Box

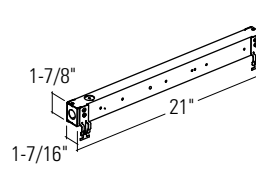

Standard Remote Box

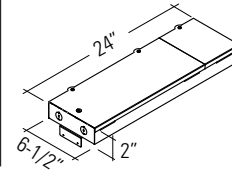

Integral Driver/ 4" Recessed Housing

EL1 ERP Power 1%, 0-10v, requires 120 or 277

Remote Driver/ Recessed with Back Box

0-10V Drivers

FSD	Factory Select Driver (1%, 0-10v)
PL2	Signify Advance Xitanium 1%, 0-10v
PL4	Advance Xitanium 347v 1%, 0-10v, requires 347v
OL2	Osram Optotronic, 1%, 0-10v
OL4	Osram Optotronic 347v, 1% 0-10v, requires 347v option
EE1	eldoLED ECOdrive 1%, 0-10v Logarithmic
ES1	eldoLED SOLOdrive 0-10v, 0% Logarithmic

DALI Drivers

EE3	eldoLED SOLOdrive .1%, DALI (logarithmic)
EE4	eldoLED SOLOdrive .1%, DALI (linear)
OD1	Osram Optotronic 1%, DEXAL
OD2	Osram Optotronic 1%, DALI 2 Channel

Lutron Drivers

LH1	Lutron Hi-lume Soft-on, Fade-to-black 1%, EcoSystem, LDE1
LH4	Lutron Hi-Lume 1%, 2-wire, Lutron-LTEA2W, 120v only

Alternate Drivers

EH1	ELV 120v only, 0-10v universal
------------	--------------------------------

Slim Remote Box

Standard Output (STD),
High Output (HO)

All Configurations

All Configurations

Standard Remote Box

Very High Output (VHO), 90CRI
Options

Very High Output (VHO), 90CRI
Options

N/A

N/A

How to specify Circuiting, Battery

- Select fixture circuiting from options below
 - Some CHUTE configurations will not accommodate all circuiting options, consult with factory

Circuiting

1	Single Circuit
M	Multi Circuit
E	Emergency Circuit only
N	Night Light Circuit only

- Battery and emergency section options are available in addition to fixture circuit
 - Select battery and emergency section options below; factory shop drawing required
 - Some CHUTE configurations will not accommodate all circuiting options, consult with factory



Battery and/or Emergency If Required

0 No battery or specific emergency section required

Battery

- Battery is REMOTE or in RECESSED BACK BOX
- Select battery section type if required, indicate total QTY. *Example 2PL*
- 90 minute battery runtime; test button is remote to fixture and requires an additional drop
- Entire fixture housing is on battery for 2' and 4' lengths
- 4' of fixture is on battery for 6' or 8' housing lengths
- PLL and ILL not available with VHO and 927HO
- For more battery options available, see [Pinnacle Resource Guide](#)

For Approximate Battery Lumen Output

- Multiply battery wattage X fixture LPW shown on Lumen Table
- $92.3 \text{ (LPW)} \times 10 \text{ (watts)} = 923 \text{ battery lumen output}$

0	No Battery
_ILL	Iota 10w Integral Lithium, Self Testing
_IRC	Iota 10w Remote
_IRH	Iota 20w Remote
_PLL	Bodine 10w Integral Lithium, Self Testing
_PRL	Bodine 7w Remote
_PRS	Bodine 7w Remote, Self Testing
_PRD	Bodine 10w Remote, Dual Flex
_PRH	Bodine 20w Remote

How to specify Emergency

Emergency

- GTD is REMOTE
- Select emergency type if required, indicate total QTY. *Example 1E*
- Emergency available in 4' increments
- Combine battery and emergency ordering codes if both options are selected

_FSG	Factory Select ALCR, Automatic Load Control Relay
_GI	Iota ETS DR, Emergency Lighting Control Device
_GB	Bodine GTD, Emergency Lighting Control Device
_E	Emergency circuit
_N	Night Light circuit
_L	Life Safety circuit section NO THROUGH WIRE

Battery OR Emergency Ordering Examples

- Single circuit, 10w Integral Battery Ordering Code: 1-1PLL
- Emergency only, 10w Integral Battery Ordering Code: E-1PLL
- Single circuit, GTD required Ordering Code: 1-1G

Combination Section Ordering Examples

- Single circuit, (1) 10w battery, (1) emergency Ordering Code: 1-1PLL1E
- Multi circuit, (2) 10w battery, (2) emergency Ordering Code: M-2PLL2E
- Single circuit, (1) night light Ordering Code: 1-1N

Finish

- Standard powder-coat textured white, metallic silver, textured black, graphite or bronze painted finish; consult factory for chip of standard paint finishes
- Selecting a fixture finish other than white may impact lumen output; consult factory for more information

W	White <i>(white cord/white canopy)</i>
S	Metallic Silver <i>(grey cord/silver canopy)</i>
BL	Textured Black <i>(black cord/black canopy)</i>
BR	Bronze <i>(white cord/bronze canopy)</i>
GR	Graphite <i>(white cord/graphite canopy)</i>
CC	Custom Color <i>(white cord/color match canopy)</i>

Endcaps

- Endcap MUST be specified.

FE	Flat Endcap
IB	Inward Bevel Endcap
OB	Outward Bevel Endcap
AT	Angled Twist Endcap

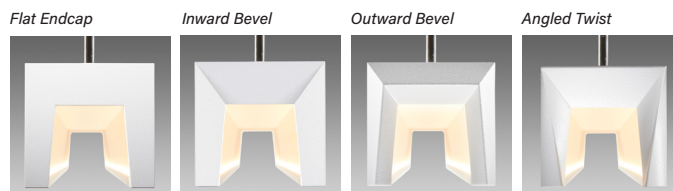



Fixture Options

- Additional options to enhance the fixture and finish of the product

DSP	Customer Supplied Battery/Driver/Sensor
CP	Chicago Plenum, applies to recessed fixtures and all necessary remote boxes

Controls

- Pinnacle is able to accommodate different control solutions from different manufacturers. Consult Factory for more information.

Photometrics

Open

Test #	ITL93-69
Catalog #	CD-N-835VHO
Lumens	4219 lm
Watts	34.5 W
Efficacy	122 LPW

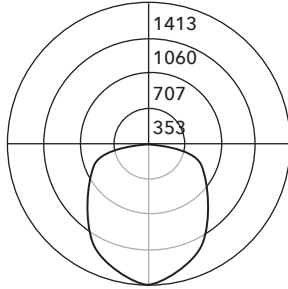

Candela Distribution

Vert Angle	Horizontal Angle				
	0	22.5	45	67.5	90
0	1411	1411	1411	1411	1411
5	1410	1394	1397	1393	1386
10	1395	1369	1360	1347	1337
15	1369	1332	1311	1292	1280
20	1335	1285	1256	1228	1215
25	1289	1229	1191	1157	1141
30	1234	1164	1117	1075	1055
35	1169	1093	1037	986	964
40	1095	1014	946	891	869
45	1010	927	850	798	782
50	918	833	751	722	716
55	816	733	661	656	656
60	709	627	585	598	603
65	593	521	517	545	552
70	476	421	456	492	500
75	357	341	397	427	428
80	235	272	322	299	272
85	121	193	111	61	46
90	31	60	40	18	0

Luminance Data (cd/sq.m)

Angle In Degrees	Average 0-Deg	Average 45-Deg	Average 90-Deg
45	17498	8801	7048
55	17058	7119	5990
65	16247	5991	5270
75	14843	5147	4422
85	11127	1692	536

Applications & Certificates

Construction: Suspended: 6063-T6 Extruded aluminum housing. Highly reflective coextruded acrylic reflector with LED protection guard. Recessed: Extruded aluminium rails and formed cold-rolled 18 gauge steel housing. Highly reflective coextruded acrylic reflector with LED protection guard.

Mounting: CHUTE Recessed is designed to install into inaccessible ceilings. Specify SF for continuous runs. Maximum recessed fixture weight is 15lbs per 4' fixture. CHUTE Suspended Aircraft cable mounting. Straight aircraft cable that mounts on 4'-0" (1219.2mm) and 8'-0" (2438.4mm) centers. Aircraft Cable supplied with 5" (127mm) power and 2" (50.8mm) non-power canopies. Refer to installation instructions for appropriate ceiling detail. Canopies are painted white unless otherwise specified. Maximum suspended fixture weight is 25 lbs. for a standard 4' fixture. Fixture can only be mounted perpendicular to bulk head.

LED: 25°C test environment. Lumen output/wattage has a margin of +/- 5%; 2' lengths may have a greater wattage deviation. All luminaire configurations tested in accordance with IES LM-79. Diodes tested in accordance with IES LM-80. Lifetime calculated using IES TM-21. Minimum lifetime greater than 60,000 hours. L70 = 146,500 hours and L90 = 45,100 hours. MacAdam 3-Step Ellipses. For all available IES files, please visit our website at pinnacle-ltg.com.

CRI, CCT & Output: Three lumen packages available. Standard, High (HO), and Very High (VHO). Custom outputs are available. Specify custom lumens or watts between standard offering listed on CRI, CCT & Output page. 80 CRI is available for 3000K, 3500K, and 4000K. 90 CRI is available for 2700K, 3000K, 3500K, and 4000K. 80 CRI = R9≥5 and 90 CRI = R9≥61.

Voltage: Universal (U), 120 volt (1), 277 volt (2) and 347 volt (3) options available. Must specify OL4 in Driver section when 347 volt (3) is selected. Some CHUTE configurations will not accommodate all voltage options; consult with factory.

Driver: CHUTE Recessed: Standard INTEGRAL Driver Option is EL1. All other driver options will be in driver backbox. CHUTE Suspended: Standard INTEGRAL Driver Option is EL1. All other driver options will be in remote box. EL1 designed for use with 120v or 277v only. Electronic driver, Power factor is >0.9 with a THD <20%. Driver Lifetime: 50,000 hours at 25°C ambient operating conditions. Ambient operating range: -20°F/-30°C to 128°F/54°C. When ND is specified, a spec grade driver will be provided. For more driver options, see Pinnacle Resource Guide. Some CHUTE configurations will not accommodate all driver options.

Suspended Section - Remote Box Mounting Guide (Advance & eldoLED)

Distance limited by max input watts shown, Direct & Indirect should be calculated separately

Max Distance	142'	107'	71'	50'	37'
4' Housing	4.9w/ft	6.4w/ft	9.5w/ft	13w/ft	N/A
8' Housing	N/A	3.1w/ft	4.8w/ft	6.9w/ft	9w/ft

Circuiting: Select from single circuit (1), Multi circuit (M), Emergency circuit (E) or Night Light circuit (N). For emergency circuiting situations that require no through wire or circuit separation, Life Safety Circuit should be selected. This will provide a separate power feed and only the Life Safety Circuit in that section. Some CHUTE configurations will not accommodate all circuiting options, consult with factory.

Battery & Emergency: Select battery or emergency options if required. If battery or emergency option is not required, enter 0. Battery duration is 90 minutes as standard. Test button is remote to fixture. For more Battery options, see Pinnacle Resource Guide.

Finish: Standard powder-coat textured white, metallic silver, textured black, graphite or bronze painted finish; consult factory for chip of standard paint finishes. Canopies painted to match fixture specified fixture finish. Contact factory for additional custom color and finish options.

Controls: Pinnacle is able to accommodate different control solutions from different manufacturers. Consult Factory for more information.

Labels: ETL listed conforming to UL 1598 in US and CSA 250 in Canada. Approved for dry/damp location unless otherwise noted.

Fixture Weight: Maximum fixture weight is 20 lbs. for a standard 4' fixture.

Buy American Act Compliant

Warranty: CHUTE LED offered with a 5-year limited warranty. Covers LED, driver and fixture.