

EDGE EV6PM

6" Recessed Perimeter

Key Features

- Extruded aluminum trim with formed cold rolled 20 gauge steel back box housing
- Highly reflective die-formed white painted steel reflector
- 5-year limited warranty covers LED, driver and fixture
- UL and cUL listed. IC rated
- Approved for dry/damp location unless otherwise noted
- Maximum fixture weight is 15lbs per 4ft fixture
- Room-Side Maintenance for LED system
- Buy American Act compliant



Example Part #: EV6PM2-A-830HO-26'-G1-U-PL2-1-0-W

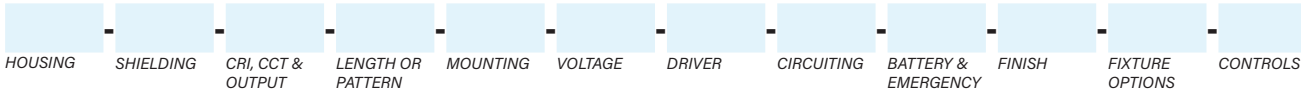

HOUSING	SHIELDING	CRI, CCT & OUTPUT ¹	LENGTH OR PATTERN ²
EV6PM - Edge 6, Perimeter EV6PM2 - Edge 6, Perimeter, 2" Regress EV6PM3 - Edge 6, Perimeter, 3" Regress EV6PM4 - Edge 6, Perimeter, 4" Regress MOD - Modifications Available <i>Housing pg. 2</i>	A - Satine Lens <i>Shielding pg. 2</i>	_27_ - 2700K _30_ - 3000K _35_ - 3500K _40_ - 4000K CL - Custom Lumens CW - Custom Watts <i>Lumen Output pg. 2</i>	_ - Individual Fixture _ - Continuous Row SI - Inside Square SO - Outside Square RI_x - Inside Rectangle RO_x - Outside Rectangle UI_x - Inside U Shape UO_x - Outside U Shape LI_x - Inside L Shape LO_x - Outside L Shape <i>Length pg. 2-3</i>
MOUNTING ³	VOLTAGE	DRIVER	CIRCUITING
G1(G) - 1" (15/16") T Bar G9(G) - 9/16" T Bar GB(G) - 9/16" Bevel T Bar GS(G) - Screw Slot T Bar FL(F) - 1/2" Flange NF(N) - Non Flange SF(S) - Spackle Flange <i>Mounting pg. 3</i>	U - Universal (120 thru 277V) 1 - 120V 2 - 277V 3 - 347V <i>Voltage pg. 4</i>	FSD - Factory Select Driver (1%, 0-10v) PL2 - Advance Xitanium (1%, 0-10v) OL2 - Osram (1%, 0-10v) OL4 - Osram 347v (1%, 0-10v) EE1 - eldoLED ECOdrive (1%, 0-10v) ES1 - eldoLED SOLOdrive (0%, 0-10v) LH1 - Lutron Hi-lume (1%, EcoSystem) L51 - Lutron 5-Series (5%, EcoSystem) PS1 - Advance Xitanium (50%/100%) <i>Driver pg. 4</i>	1 - Single Circuit M - Multi Circuit E - Emergency (entire fixture) N - Night Light (entire fixture) <i>Circuiting pg. 4</i>
BATTERY & EMERGENCY ⁴	FINISH	FIXTURE OPTIONS	CONTROLS
0 - None _FSG - Factory Select ALCR _GB - Bodine GTD _GI - Iota ETS DR _P - Bodine 10W _IC - Iota 10W (CEC Listed) _E - Emergency Circuit Section _N - Night Light Circuit Section _L - Life Safety Circuit Section <i>Battery and Emergency pg. 4-5</i>	W - White S - Metallic Silver BL - Textured Black BR - Bronze GR - Graphite CC - Custom Color <i>Finish pg. 5</i>	CP - Chicago Plenum GLR - Internal Fast Blow Fuse FIL - Field Cut Illuminated Extension <i>Fixture Options pg. 5</i>	<i>Pinnacle is able to accommodate different control solutions from different manufacturers. Consult Factory for more information.</i>

¹When specifying CRI, CCT & OUTPUT the first _ is for specifying either **8** - 80CRI or **9** - 90CRI. The ending _ _ are for specifying output, example **HO** - High Output. See output charts for more information. ²Individual fixtures come in 2', 3', 4', 5', 6' & 8' lengths. Continuous row come in 1/8" increments. For Patterns specify pattern shape and overall dimensions. Example: L6x4: L pattern that is 6'x4'. ³Specify mounting for individual or continuous length: G1, G9, GS, FL, NF, SF for continuous rows, G1G, G9G, GSG, FLF, NFN & SFS for individual lengths. ⁴Enter quantity for Battery and Emergency, Example 2P.

Specifications and dimensions subject to change without notice. Specification sheets that appear on pinnacle-ltg.com are the most recent version and supersede all other previously printed or electronic versions.



Housing

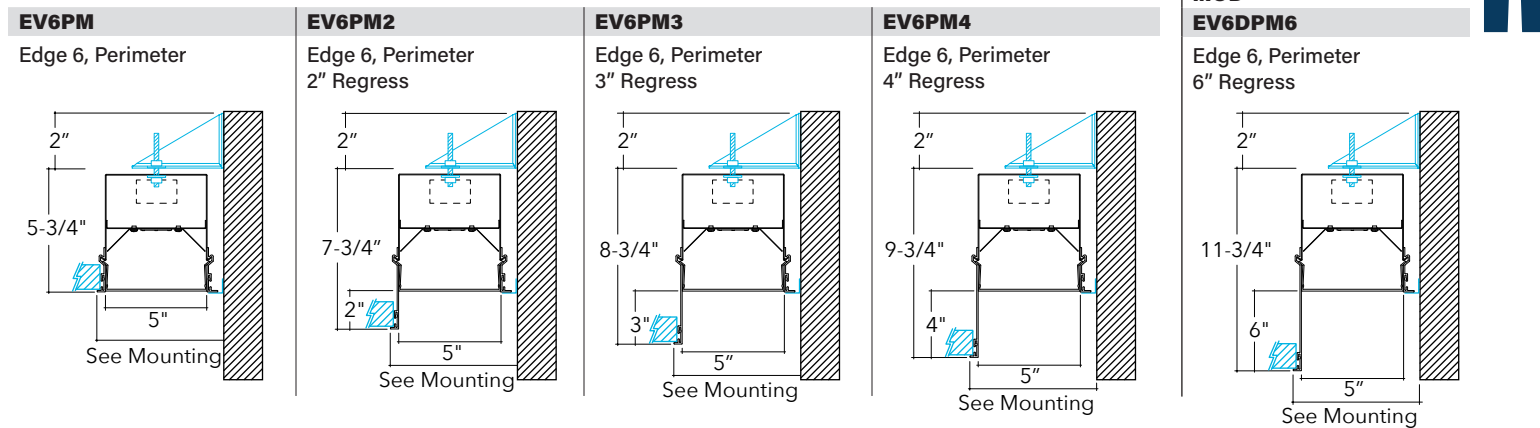

Shielding

A

Satine Lens

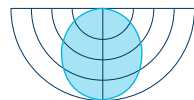

CRI, CCT & Output

- Specify either 80 or 90 CRI
- Longer lead-time may apply for 90 CRI. Consult factory
- 80 CRI = R9≥19 and 90 CRI = R9≥61

Custom Output - Lumens OR Wattage

CL _____	Specify CRI, CCT and desired lumens (i.e. CL835500)	<i>Specify lumens between standard offering listed below. Lumens are specified per color temp</i>
CW _____	Specify CRI, CCT and desired wattage (i.e. CW9407)	<i>Specify watts between standard offering listed below</i>

80 CRI

	Color	Output	Watts <i>per foot</i>	Shielding A Satine <i>Lumens/ft</i>	
				<i>Lumens/ft</i>	<i>LPW</i>
830	3000K	Standard	4.6	411	88.9
830HO	3000K	High	8.7	752	86.9
835	3500K	Standard	4.6	423	91.5
835HO	3500K	High	8.7	774	89.4
840	4000K	Standard	4.6	431	93.2
840HO	4000K	High	8.7	788	91.1

90 CRI

927	2700K	Standard	4.6	325	70.2
927HO	2700K	High	8.7	594	68.7
930	3000K	Standard	4.6	379	81.9
930HO	3000K	High	8.7	693	80.1
935	3500K	Standard	4.6	381	82.4
935HO	3500K	High	8.7	696	80.5
940	4000K	Standard	4.6	385	83.2
940HO	4000K	High	8.7	704	81.4

Specifications and dimensions subject to change without notice. Specification sheets that appear on pinnacle-ltg.com are the most recent version and supersede all other previously printed or electronic versions.



Length

- Individual units cannot be joined, end trims are factory installed and cannot be removed
- Refer to Pattern section for specification and ordering options
- Continuous Rows are made up of even and odd length fixtures; designed to fall on-grid

2	3	4	5	6	8	–
Indiv. Fixture	Indiv. Fixture	Indiv. Fixture	Indiv. Fixture	Indiv. Fixture	Indiv. Fixture	Cont. Run <i>Specify nominal overall row length to the 1/8"</i>
23" (584.2mm)	35" (889mm)	47" (1193.8mm)	59" (1498.6mm)	71" (1803.4mm)	95" (2413mm)	
						Specify to the 1/8" >>>

Pattern

- Specify pattern shape and overall dimensions (includes corner dimensions)
- 90 degree horizontal corners are 12"x12" (overall, outside dimension)
- Use with Field Cut Illuminated extensions (**FIL**) to fit to wall to wall dimensions
- Not all drivers available with all patterns; consult factory

SI_	SO_	RI_x_	RO_x_	UI_x_x_	UO_x_x_	LI_x_	LO_x_
Square, Inside (SI) or Outside (SO) <i>Provide overall length dimension for each fixture leg</i>		Rectangle, Inside (RI) or Outside (RO) <i>Provide overall length dimension for each fixture leg</i>		U-Shape, Inside (UI) or Outside (UO) <i>Provide overall length dimension for each fixture leg</i>		L-Shape, Inside (LI) or Outside (LO) <i>Provide overall length dimension for each fixture leg</i>	

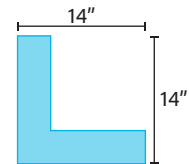
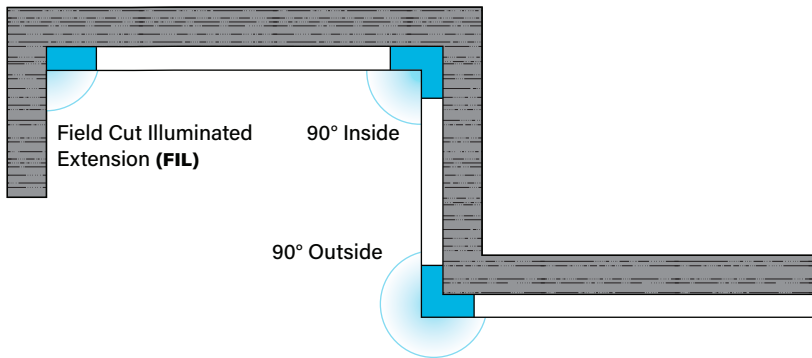



Mounting

- Individual Units: specify G_G, FLF, SFS, NFN
- Continuous Units: specify G_, FL, SF, NF
- All individual units cannot be joined, end trims are factory installed and cannot be removed
- Designed to install into acoustical grid and inaccessible ceilings
- Grid retention brackets integral to housing and require mechanical attachment
- Each housing contains 4 grid retention brackets
- Tie off fixture to structure with retention wires
- Approved for dry/damp location unless otherwise noted

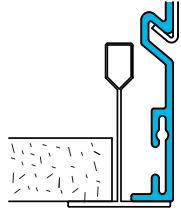
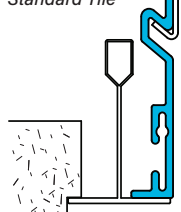
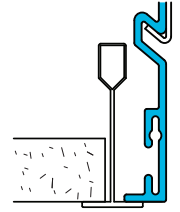
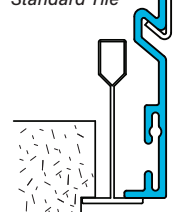
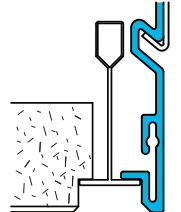
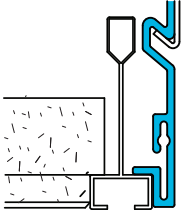
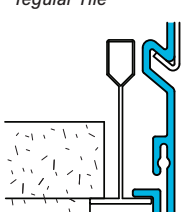
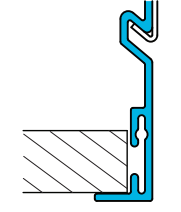
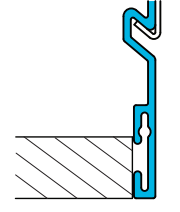
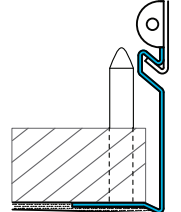
G1G Individual Unit	G9G	GBG	GSG	FLF	NFN	SFS
G1 Continuous Run or Pattern	G9	GB	GS	FL	NF	SF
<p>1" (15/16") T-Bar Flange to Flange: 5-13/16" (96.5mm)</p>  <p>Standard Tile</p>  <p>Tegular Tile</p>	<p>9/16" T-Bar For tegular tile installations, fixture position will not be flush to the bottom of the tile Flange to Flange: 5-13/16" (96.5mm)</p>  <p>Standard Tile</p>  <p>Tegular Tile</p>	<p>9/16" T-Bar Rail has bevel edge details. For tegular tile installations, fixture position will be flush to the bottom of the tile Flange to Flange: 5-13/16" (96.5mm)</p>  <p>Tegular Tile</p>	<p>Screw Slot & 9/16" T-Bar For 9/16" installations with tegular tile, fixture position will be flush to the bottom of the tile Flange to Flange: 5-13/16" (96.5mm)</p>  <p>Tegular Tile</p>  <p>Tegular Tile</p>	<p>Exposed Standard 1/2" Flange Detail Flange to Flange: 6-1/8" (104.1mm)</p> 	<p>Metal Pan or Millwork Flange to Flange: 5-7/16" (86.6mm)</p> 	<p>Drywall, Flangeless Detail Flange to Flange: 6-15/16" (126.5mm)</p> 

Voltage

- Some EV6 configurations will not accommodate all voltage options; consult with factory

U	Universal
1	120 volt
2	277 volt
3	347 volt

Driver

- Standard Driver Option = FSD
- Driver Lifetime: 50,000 hours at 25°C ambient operating conditions
- For more driver options see Pinnacle Resource Guide
- Some EV6 configurations will not accommodate all driver options; consult with factory

0-10V Drivers	
FSD	Factory Select Driver 1%, 0-10v
PL2	Signify Advance Xitanium 1%, 0-10v
PL4	Advance Xitanium 347v 1%, 0-10v, requires 347v
OL2	Osram Optotronic, 1%, 0-10v
OL4	Osram Optotronic 347v, 1% 0-10v, requires 347v option
EE1	eldoLED ECOdrive 1%, 0-10v Logarithmic
EE2	eldoLED ECOdrive 1%, 0-10v Linear
ES1	eldoLED SOLOdrive 0-10v, 0% Logarithmic
ES2	eldoLED SOLOdrive 0-10v, 0% Linear
DALI Drivers	
EE3	eldoLED SOLOdrive .1%, DALI (logarithmic)
EE4	eldoLED SOLOdrive .1%, DALI (linear)
OD1	Osram Optotronic 1%, DEXAL
OD2	Osram Optotronic 1%, DALI 2 Channel
Lutron Drivers	
LH1	Lutron Hi-lume Soft-on, Fade-to-black 1%, EcoSystem, LDE1
LH4	Lutron Hi-Lume 1%, 2-wire, Lutron-LTEA2W, 120v only
Alternate Drivers	
PS1	Signify Advance Xitanium Step Dimming 50%/100%
EH1	ELV 120v only, 0-10v universal

Specifications and dimensions subject to change without notice. Specification sheets that appear on pinnacle-ltg.com are the most recent version and supersede all other previously printed or electronic versions.

Designed in Denver, CO • USA | pinnacle-ltg.com | O: 303-322-5570 F: 303-322-5568

EV6DPM_LED_SPEC_MAY2022



How to specify Circuiting, Battery and Emergency

- 1**
- Select fixture circuiting from options below
 - Some EV6 configurations will not accommodate all circuiting options, consult with factory

Circuiting

1	Single Circuit
M	Multi Circuit
E	Emergency Circuit only
N	Night Light Circuit only

- 2** + **3**
- Battery and emergency section options are available in addition to fixture circuit
 - Select battery and emergency section options below; factory shop drawing required
 - Some EV6 configurations will not accommodate all circuiting options, consult with factory

Battery and/or Emergency If Required

- 0** No battery or specific emergency section required

Battery

- Select battery section type if required, indicate total QTY. Example 2P
- 90 minute battery runtime; test button is remote to fixture and requires an additional drop
- No battery option available for 2' lengths
- Entire fixture is on battery for lengths up to 5'
- Half of fixture is on battery for 6" or 8' housing lengths
- For more battery options available, see Pinnacle Resource Guide

0	No Battery
_IC	Iota 10w Integral
_ILL	Iota 10w Integral Lithium, Self Testing
_IRH	Iota 20w Remote
_P	Bodine 10w Integral
_PLL	Bodine 10w Integral Lithium, Self Testing
_PRH	Bodine 20w Remote

For Approximate Battery Lumen Output

- Multiply battery wattage X fixture LPW shown on Lumen Table
- $92.3 \text{ (LPW)} \times 10 \text{ (watts)} = 923 \text{ battery lumen output}$

Emergency

- Select emergency section type if required, indicate total QTY. Example 1E
- Combine battery and emergency section ordering codes if both options are selected

_FSG	Factory Select ALCR, Automatic Load Control Relay
_GI	Iota ETS DR, Emergency Lighting Control Device
_GB	Bodine GTD, Emergency Lighting Control Device
_E	Emergency circuit section
_N	Night Light circuit section
_L	Life Safety circuit section NO THROUGH WIRE

Battery OR Emergency Ordering Examples

- Single circuit, 10w Integral Battery Ordering Code: 1-1P
- Emergency only, 10w Integral Battery Ordering Code: E-1P
- Single circuit, GTD required Ordering Code: 1-1G

Combination Section Ordering Examples

- Single circuit, (1) 10w battery, (1) emergency section Ordering Code: 1-1P1E
- Multi circuit, (2) 10w battery, (2) emergency sections Ordering Code: M-2P2E
- Single circuit, (1) night light section Ordering Code: 1-1N

Finish

- Standard powder-coat textured white, metallic silver, textured black, graphite or bronze painted finish; consult factory for chip of standard paint finishes
- Selecting a fixture finish other than white may impact lumen output; consult factory for more information

W	White
S	Metallic Silver
BL	Textured Black
GR	Graphite
BR	Bronze
CC	Custom Color

Fixture Options

- Additional options to enhance the fixture and finish of the product
- FIL has 2" min - 12" max length
- FIL Option angle range is 40° to 90°
- FIL Option is not IC rated

CP	Chicago Plenum
GLR	Internal Fast Blow Fuse
FIL	Field Cut Illuminated Extension

Specifications and dimensions subject to change without notice. Specification sheets that appear on pinnacle-ltg.com are the most recent version and supersede all other previously printed or electronic versions.

Designed in Denver, CO • USA | pinnacle-ltg.com | O: 303-322-5570 F: 303-322-5568

EV6DPM_LED_SPEC_MAY2022



Controls

- Pinnacle is able to accommodate different control solutions from different manufacturers. Consult Factory for more information.

Photometrics

Satine Lens

Test #	ITL86394
Catalog #	EV6A-840-4
Lumens	1724 lm
Watts	18.5 W
Efficacy	93 LPW

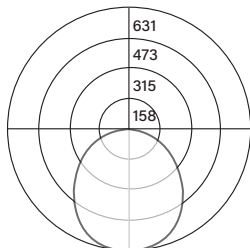

Candela Distribution

Vert Angle	Horizontal Angle				
	0	22.5	45	67.5	90
0	631	631	631	631	631
5	627	627	627	627	631
10	619	616	616	616	615
15	602	598	599	599	596
20	582	575	578	575	574
25	553	546	548	545	543
30	521	514	516	512	508
35	483	476	477	473	470
40	442	436	436	432	429
45	399	393	393	389	386
50	354	350	348	344	343
55	308	304	303	300	298
60	261	257	256	254	253
65	213	211	209	207	207
70	167	165	163	162	162
75	121	119	118	118	118
80	78	77	76	75	75
85	38	37	37	36	36
90	0	0	0	0	0

Luminance Data (cd/sq.m)

Angle In Degrees	Average 0-Deg	Average 45-Deg	Average 90-Deg
45	3722	3666	3599
55	3535	3477	3418
65	3321	3257	3225
75	3087	3009	3009
85	2851	2774	2697

For all available IES files, please visit our website at pinnacle-ltg.com. Photometry testing in accordance to IESNA-LM-79-08 at an NVLAP accredited testing laboratory. Testing conducted at 25°C ambient conditions

Applications & Certificates

Housing: Extruded aluminum trim with formed cold rolled 20 gauge steel back box housing. Highly reflective die-formed white painted steel reflector.

Shielding: Diffuse snap-in acrylic lens, removable for maintenance.

Mounting: Evolution is designed to install into acoustical grid and inaccessible ceilings. Specify GXG, FLF, SFS, NFN for individual, unjoinable units (individual units will fall on-grid). Specify GX, FL, SF, NF for continuous runs (runs designed to fall on-grid). Grid retention brackets are integral to housing. Each housing contains 4 grid retention brackets. Consult factory for detailed installation instructions. Maximum fixture weight is 15lbs per 4' fixture.

LED: 25°C test environment. Lumen output/wattage has a margin of +/- 5%; 2' or 3' lengths may have a greater wattage deviation. All luminaire configurations tested in accordance with IES LM-79. Diodes tested in accordance with IES LM-80. Lifetime calculated using IES TM-21. Minimum lifetime greater than 60,000 hours. Lifetime Projection L70 = 135,200 hours and L90 = 40,300 hours. MacAdam 3-Step Ellipses. Not all products are Lighting Facts listed. For all available IES files, please visit our website at pinnacle-ltg.com.

CRI, CCT & Lumen Output: Two lumen packages available. Standard and High (HO). Custom outputs are available. Specify custom lumens or watts between standard offering listed on CRI, CCT & Output page. 80 CRI is available for 3000K, 3500K, and 4000K. 90 CRI is available for 2700K, 3000K, 3500K, and 4000K. 80 CRI = R9≥19 and 90 CRI = R9≥61.

Voltage: Universal (U), 120 volt (1), 277 volt (2) and 347 volt (3) options available. Must specify OL4 in Driver section when 347 volt (3) is selected. Some Evolution configurations will not accommodate all voltage options; consult with factory.

Driver: Standard Driver Option is Advance Xitanium 0-10V, 1% = PL2. Electronic driver, power factor is >0.9 with a THD <20%. Driver Lifetime: 50,000 hours at 25°C ambient operating conditions. Ambient operating range: -20°F/-30°C to 98°F/37°C. For more driver options, see Pinnacle Resource Guide. Some EDGE configurations will not accommodate all driver options.

Circuiting: Select from single circuit (1), Multi circuit - For multiple circuiting and zone control, requires factory shop drawing (M), Emergency circuit (E), Life Safety (L) or Night Light circuit (N). For emergency circuiting situations that require no through wire or circuit separation, Life Safety Circuit should be selected. This will provide a separate power feed and only the Life Safety Circuit in that section. Some EDGE configurations will not accommodate all circuiting options; consult with factory.

Battery & Emergency: Select battery or emergency options if required. If battery or emergency option is not required, enter 0. Battery duration is 90 minutes as standard. Test button is remote to fixture. For more Battery options, see Pinnacle Resource Guide.

Finish: Standard powder-coat textured white, metallic silver, textured black, graphite or bronze painted finish; consult factory for chip of standard paint finishes or for additional custom color and finish options.

Controls: Consult factory.

Labels: UL and cUL Listed. Standard and HO lumen packages are IC Rated, approved for dry/damp location unless otherwise noted.

Fixture Weight: Maximum fixture weight is 15lbs per 4' fixture.

Buy American Act Compliant

Warranty: Evolution LED offered with a 5-year limited warranty. Covers LED, driver and fixture.

Specifications and dimensions subject to change without notice. Specification sheets that appear on pinnacle-ltg.com are the most recent version and supersede all other previously printed or electronic versions.

Designed in Denver, CO • USA | pinnacle-ltg.com | O: 303-322-5570 F: 303-322-5568

EV6DPM_LED_SPEC_MAY2022