

EDGE EV3DPM

3" Recessed Perimeter

Key Features

- Extruded aluminum trim with formed cold rolled 18 gauge steel back box housing
- Highly reflective white painted steel reflector
- 5-year limited warranty covers LED, driver and fixture
- UL and cUL listed. IC rated
- Approved for dry/damp location unless otherwise noted
- Maximum fixture weight is 15lbs per 4ft fixture
- Room-Side Maintenance for LED system
- Buy American Act compliant
- Indigo-Clean available, see Indigo-Clean specification sheets for details



Example Part #: EV3DPM-HE-830HO-26'-G1-U-PL2-1-0-W

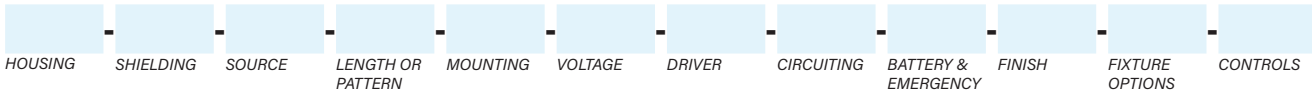

HOUSING	SHIELDING	SOURCE	LENGTH OR PATTERN ²
EV3DPM - Edge 3, Perimeter EV3DPM2 - Edge 3, Perimeter, 2" Regress EV3DPM3 - Edge 3, Perimeter, 3" Regress EV3DPM4 - Edge 3, Perimeter, 4" Regress MOD - Modifications Available <i>Housing pg. 2</i>	A - Satine Lens HE - High Efficiency Lens R - Regress Lens WHE - Asymmetric Lens <i>Shielding pg. 2</i>	_27_ - 2700K _30_ - 3000K _35_ - 3500K _40_ - 4000K TW3 - Tunable White (Blanco 3) CL - Custom Lumens CW - Custom Watts MOD - Mod options available <i>Lumen Output pg. 2-3</i>	_ - Individual Fixture _ - Continuous Row SI - Inside Square SO - Outside Square RI_x - Inside Rectangle RO_x - Outside Rectangle UI_x - Inside U Shape UO_x - Outside U Shape LI_x - Inside L Shape LO_x - Outside L Shape <i>Length pg. 3</i>
MOUNTING ³	VOLTAGE	DRIVER	CIRCUITING
G1(G) - 1" (15/16") T Bar G9(G) - 9/16" T Bar GB(G) - 9/16" Bevel T Bar GS(G) - Screw Slot T Bar FL(F) - 1/2" Flange NF(N) - Non Flange SF(S) - Spackle Flange MOD - Mod options available <i>Mounting pg. 4</i>	U - Universal <i>(120 thru 277V)</i> 1 - 120V 2 - 277V 3 - 347V <i>Voltage pg. 4</i>	FSD - Factory Select Driver (1%, 0-10v) PL2 - Advance Xitanium (1%, 0-10v) OL2 - Osram (1%, 0-10v) OL4 - Osram 347v (1%, 0-10v) EE1 - eldoLED ECOdrive (1%, 0-10v) ES1 - eldoLED SOLOdrive (0%, 0-10v) LH1 - Lutron Hi-lume (1%, EcoSystem) L51 - Lutron 5-Series (5%, EcoSystem) PR1 - Advance Xitanium SR MOD - Mod options available <i>Driver pg. 5</i>	1 - Single Circuit M - Multi Circuit E - Emergency <i>(entire fixture)</i> N - Night Light <i>(entire fixture)</i> <i>Circuiting pg. 6</i>
BATTERY & EMERGENCY ⁴	FINISH	FIXTURE OPTIONS	CONTROLS ⁵
0 - None _FSG - Factory Select ALCR _GB - Bodine GTD _GI - Iota ETS DR _P - Bodine 10W _IC - Iota 10W (CEC Listed) _E - Emergency Circuit Section _N - Night Light Circuit Section _L - Life Safety Circuit Section <i>Battery and Emergency pg. 6</i>	W - White S - Metallic Silver BL - Textured Black BR - Bronze GR - Graphite CC - Custom Color <i>Finish pg. 6</i>	CP - Chicago Plenum GLR - Internal Fast Blow Fuse FIL - Field Cut Illuminated Extension MOD - Mod options available <i>Fixture Options pg. 6</i>	B3LM - Wattstopper Blanco 3 DLM (wired) MOD - Mod options available <i>Controls pg. 7</i>

¹When specifying SOURCE the first _ is for specifying either 8 - 80CRI or 9 - 90CRI The ending _ are for specifying output, example **HO** - High Output. See output charts for more information. ²Individual fixtures come in 2', 3', 4', 5', 6', 7' & 8' lengths. Continuous row come in 1/8" increments. ³Specify mounting for individual or continuous length: G1, G9, GS, FL, NF & SF for continuous rows, G1G, G9G, GSG, FLF, NFN & SFS for individual lengths. ⁴Enter quantity for Battery and Emergency, Example 2P. ⁵Controls can only be used with Single Circuit (1) or Emergency Circuit (E). See Controls chart on page 5 for driver options and more information.

Specifications and dimensions subject to change without notice. Specification sheets that appear on pinnacle-ltg.com are the most recent version and supersede all other previously printed or electronic versions.



Housing

- Mounting bolt allows for adjustability of mount height. If fixture is flushed to mount bracket, distance to ceiling would be bracket height (2") + fixture height (dependent on regress).

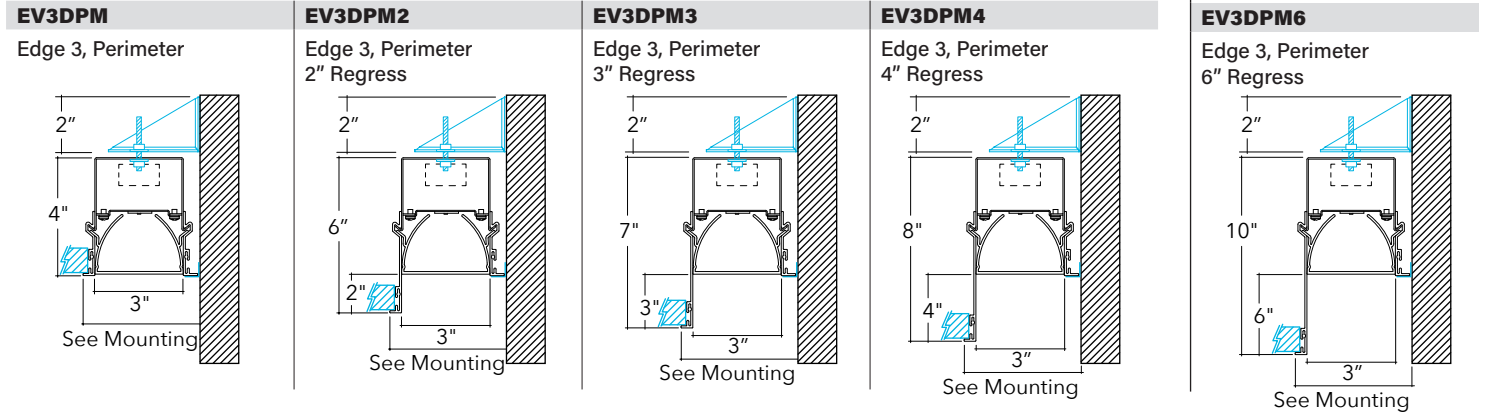

Shielding

- Regress Lens option uses housing with backbox. Back box does not impact mounting, see detail.
- Asymmetric Lens option recommended for use pointing away from wall.
- Regress Lens option not available with corners.

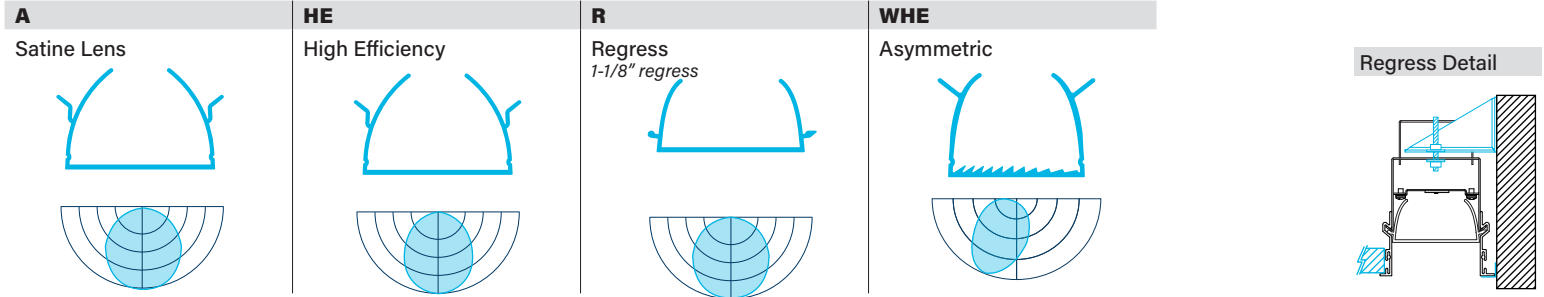

Source: White LED¹

- Specify either 80 or 90 CRI
- Longer lead-time may apply for 90 CRI. Consult factory
- 80 CRI = R9≥19 and 90 CRI = R9≥61

Custom Output - Lumens OR Wattage

CL _____	Specify CRI, CCT and desired lumens (i.e. CL835500)	Specify lumens between standard offering listed below. Lumens are specified per color temp
CW _____	Specify CRI, CCT and desired wattage (i.e. CW9407)	Specify watts between standard offering listed below

80 CRI

	Color	Lumens per foot	Shielding ¹							
			A Satine		HE High Efficiency		R Regress		WHE Asymmetric	
			LPW	Watts/ft	LPW	Watts/ft	LPW	Watts/ft	LPW	Watts/ft
830	3000K	500	119	4.2	134	3.7	117	4.3	131	3.8
830HO	3000K	750	119	6.3	139	5.4	117	6.4	135	5.5
830VHO	3000K	1000	122	8.2	140	7.1	119	8.4	136	7.3
835	3500K	500	123	4.1	138	3.6	121	4.1	135	3.7
835HO	3500K	750	123	6.1	144	5.2	120	6.2	140	5.3
835VHO	3500K	1000	126	7.9	144	6.9	123	8.1	141	7.1
840	4000K	500	123	4.1	138	3.6	121	4.1	135	3.7
840HO	4000K	750	123	6.1	144	5.2	120	6.2	140	5.3
840VHO	4000K	1000	126	7.9	144	6.9	123	8.1	141	7.1

90 CRI

927	2700K	500	100.3	5.0	113	4.4	97	5.2	110	4.5
927HO	2700K	750	102.7	7.3	112	6.7	98	7.6	109	6.9
930	3000K	500	108.3	4.6	123	4.1	103	4.8	120	4.2
930HO	3000K	750	105.9	7.1	123	6.1	106	7.1	120	6.3
935	3500K	500	107.9	4.6	122	4.1	103	4.9	119	4.2
935HO	3500K	750	105.5	7.1	123	6.1	105	7.1	119	6.3
940	4000K	500	107.9	4.6	122	4.1	103	4.9	119	4.2
940HO	4000K	750	105.5	7.1	123	6.1	105	7.1	119	6.3

¹LPW and watts/ft based off 47" fixture size.

Specifications and dimensions subject to change without notice. Specification sheets that appear on pinnacle-ltg.com are the most recent version and supersede all other previously printed or electronic versions.



Source: Blanco3¹

- CRI >90, R9 >92
- 3 Channel tunable white for precise black body curve CCT
- Allows for high color consistency between fixtures
- Self-commissioning with Wattstopper DLM integrated controls
- Requires Control Ordering Code **B3LM** (pg. 6)
- Requires Drive Ordering Code **EC2** (pg. 4)

Blanco 3 Tunable White (TW3)

TW3	Range	Shielding ¹			HE		
		A Satine			High Efficiency		
		Lumens/ft	LPW	Watts/ft	Lumens/ft	LPW	Watts/ft
	2700-6500K	653	77	8.5	754	88	8.5

¹LPW and watts/ft based off 47" fixture size.

Source: MOD Options

- Specify **MOD** in the part number for any of the below options
- All **RGB_** Source Options will require specific driver and control
- Consult factory for **MOD** specification details, pricing, and lead-time information

MOD	Required Driver		Required Control	
	Color Changing RGB LED	Color Changing RGB-W LED	Color Changing RGB-A LED	2 Channel Tunable White
	EC2	EC2	DMX	DMX
	EC2		DMX	

Length

- All individual units cannot be joined, end trims are factory installed and cannot be removed
- Refer to Pattern section for specification and ordering options
- Continuous Rows are made up of even and odd length fixtures; designed to fall on-grid

2	3	4	5	6	7	8	-
Indiv. Fixture	Indiv. Fixture	Indiv. Fixture	Indiv. Fixture	Indiv. Fixture	Indiv. Fixture	Indiv. Fixture	Cont. Run
23" (584.2mm)							Specify nominal overall row length to the 1/8"
	35" (889mm)						
		47" (1193.8mm)					
			59" (1498.6mm)				
				71" (1803.4mm)			
					83" (2108.2mm)		
						95" (2413mm)	

Specify to the 1/8" >>>

Pattern

- Specify pattern shape and overall dimensions (includes corner dimensions)
- 90 degree horizontal corners are 12"x12" (overall, outside dimension)
- Use with Field Cut Illuminated extensions (**FIL**) to fit to wall to wall dimensions
- Not all drivers available with all patterns; consult factory

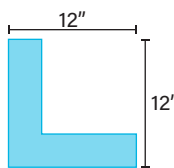

SI_	SO_	RI_x_	RO_x_	UI_x_x_	UO_x_x_	LI_x_	LO_x_
Square, Inside (SI) or Outside (SO) Provide overall length dimension for each fixture leg		Rectangle, Inside (RI) or Outside (RO) Provide overall length dimension for each fixture leg		U-Shape, Inside (UI) or Outside (UO) Provide overall length dimension for each fixture leg		L-Shape, Inside (LI) or Outside (LO) Provide overall length dimension for each fixture leg	

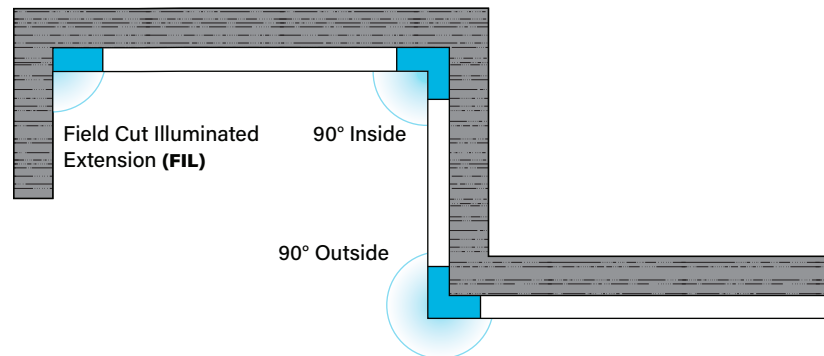

Specifications and dimensions subject to change without notice. Specification sheets that appear on pinnacle-ltg.com are the most recent version and supersede all other previously printed or electronic versions.

Designed in Denver, CO - USA | pinnacle-ltg.com | O: 303-322-5570 F: 303-322-5568

EV3DPM_LED_SPEC_MAY2022



Mounting

- Individual Units, specify G_G, FLF, SFS, NFN
- Continuous Units, specify G_, FL, SF, NF
- Individual units cannot be joined, end trims are factory installed and cannot be removed
- Designed to install into acoustical grid and inaccessible ceilings
- Grid retention brackets integral to housing and require mechanical attachment
- Each housing contains 4 grid retention brackets
- Tie off fixture to structure with retention wires
- Approved for dry/damp location unless otherwise noted

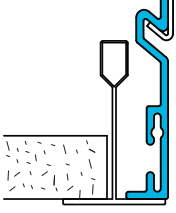
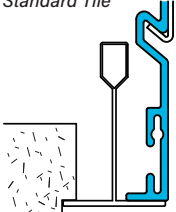
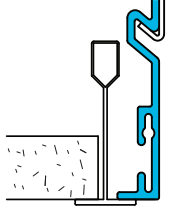
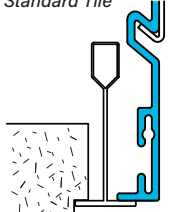
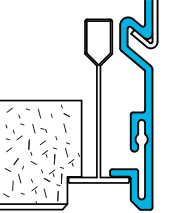
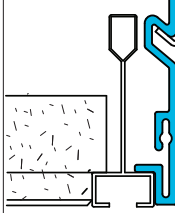
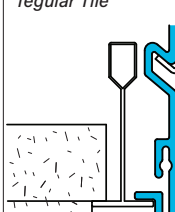
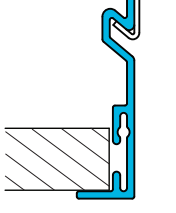
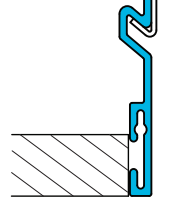
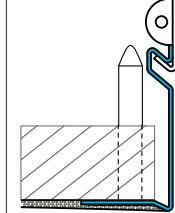
G1G Individual Unit	G9G	GBG	GSG	FLF	NFN	SFS
G1 Continuous Run or Pattern	G9	GB	GS	FL	NF	SF
<p>1" (15/16") T-Bar Flange to Flange: 3-13/16" (96.5mm)</p>  <p>Standard Tile</p>  <p>Tegular Tile</p>	<p>9/16" T-Bar For tegular tile installations, fixture position will not be flush to the bottom of the tile Flange to Flange: 3-13/16" (96.5mm)</p>  <p>Standard Tile</p>  <p>Tegular Tile</p>	<p>9/16" T-Bar Rail has bevel edge details. For tegular tile installations, fixture position will be flush to the bottom of the tile Flange to Flange: 3-13/16" (96.5mm)</p>  <p>Tegular Tile</p>	<p>Screw Slot & 9/16" T-Bar For 9/16" installations with tegular tile, fixture position will be flush to the bottom of the tile Flange to Flange: 3-13/16" (96.5mm)</p>  <p>Tegular Tile</p>  <p>Tegular Tile</p>	<p>Exposed Standard 1/2" Flange Detail Flange to Flange: 4-1/8" (104.1mm)</p> 	<p>Metal Pan or Millwork Flange to Flange: 3-7/16" (86.6mm)</p> 	<p>Drywall, Flangeless Detail Flange to Flange: 4-15/16" (126.5mm)</p> 

Mounting: MOD Options

- Specify **MOD** in the part number for any of the below options
- Consult factory for **MOD** specification details, pricing, and lead-time information

	Description
MOD	Alternative Ceiling Solutions

Voltage

- Some EV3D configurations will not accommodate all voltage options; consult with factory

U	Universal
1	120 volt
2	277 volt
3	347 volt



Driver

- Standard Driver Option = FSD
- Driver Lifetime: 50,000 hours at 25°C ambient operating conditions
- For more driver options see Pinnacle Resource Guide
- Some EV3D configurations will not accommodate all driver options; consult with factory

0-10V Drivers	
FSD	Factory Select Driver 1%, 0-10v
PL2	Signify Advance Xitanium 1%, 0-10v
PL4	Advance Xitanium 347v 1%, 0-10v, requires 347v
OL2	Osram Optotronic, 1%, 0-10v
OL4	Osram Optotronic 347v, 1% 0-10v, requires 347v option
EE1	eldoLED ECOdrive 1%, 0-10v Logarithmic
EE2	eldoLED ECOdrive 1%, 0-10v Linear
ES1	eldoLED SOLOdrive 0-10v, 0% Logarithmic
ES2	eldoLED SOLOdrive 0-10v, 0% Linear
OL5	Osram Optotronic 1%, 0-10v, AUX
DALI Drivers	
EE3	eldoLED SOLOdrive .1%, DALI (logarithmic)
EE4	eldoLED SOLOdrive .1%, DALI (linear)
OD1	Osram Optotronic 1%, DEXAL
OD2	Osram Optotronic 1%, DALI 2 Channel
Lutron Drivers	
LH1	Lutron Hi-lume Soft-on, Fade-to-black 1%, EcoSystem, LDE1
LH4	Lutron Hi-Lume 1%, 2-wire, Lutron-LTEA2W, 120v only
Alternate Drivers	
PS1	Signify Advance Xitanium Step Dimming 50%/100%
PR1	Philips Advance Xitanium SR, requires EASYS, VDO, or VRF
EH1	ELV 120v only, 0-10v universal

Driver: MOD Options

- Specify **MOD** in the part number for any of the below options
- Consult factory for **MOD** specification details, pricing, and lead-time information

	Description
MOD	Power Over Ethernet

How to specify Circuiting, Battery and Emergency

- Select fixture circuiting from options below
 - Some EV3D configurations will not accommodate all circuiting options, consult with factory

Circuiting

1	Single Circuit
M	Multi Circuit (Not available with controls)
E	Emergency Circuit only (uses nIO EZ PH ER with NLIGHT)
N	Night Light Circuit only

- Battery and emergency section options are available in addition to fixture circuit
 - Select battery and emergency section options below; factory shop drawing required
 - Some EV3D configurations will not accommodate all circuiting options, consult with factory

Battery and/or Emergency If Required

0	No battery or specific emergency section required
----------	---



Battery

- Select battery section type if required, indicate total QTY. *Example 2P*
- 90 minute battery runtime; test button is remote
- No battery option available for 2' & 3' lengths

- Entire fixture is on battery for lengths up to 5'
- Half of fixture is on battery for 6' or 8' housing lengths
- For more battery options available, see Pinnacle Resource Guide

0	No Battery
_IC	Iota 10w Integral
_ILL	Iota 10w Integral Lithium, Self Testing
_IRH	Iota 20w Remote
_P	Bodine 10w Integral
_PLL	Bodine 10w Integral Lithium, Self Testing
_PRH	Bodine 20w Remote

For Approximate Battery Lumen Output

- Multiply battery wattage X fixture LPW shown on Lumen Table
- 92.3 (LPW) x 10 (watts) = 923 battery lumen output

Emergency

- Select emergency section type if required, indicate total QTY. *Example 1E*
- Combine battery and emergency section ordering codes if both options are selected

_FSG	Factory Select ALCR, Automatic Load Control Relay
_GI	Iota ETS DR, Emergency Lighting Control Device
_GB	Bodine GTD, Emergency Lighting Control Device
_E	Emergency circuit section
_N	Night Light circuit section
_L	Life Safety circuit section NO THROUGH WIRE

Battery OR Emergency Ordering Examples

- Single circuit, 10w Integral Battery Ordering Code: 1-1P
- Emergency only, 10w Integral Battery Ordering Code: E-1P
- Single circuit, GTD required Ordering Code: 1-1G

Combination Section Ordering Examples

- Single circuit, (1) 10w battery, (1) emergency section Ordering Code: 1-1P1E
- Multi circuit, (2) 10w battery, (2) emergency sections Ordering Code: M-2P2E
- Single circuit, (1) night light section Ordering Code: 1-1N

Finish

- Standard powder-coat textured white, metallic silver, textured black, graphite or bronze painted finish; consult factory for chip of standard paint finishes
- Selecting a fixture finish other than white may impact lumen output; consult factory for more information

W	White
S	Metallic Silver
BL	Textured Black
GR	Graphite
BR	Bronze
CC	Custom Color

Fixture Options

- Additional options to enhance the fixture and finish of the product
- FIL has 2" min - 12" max length

- FIL Option angle range is 40° to 90°
- FIL Option is not IC rated

CP	Chicago Plenum
GLR	Internal Fast Blow Fuse
FIL	Field Cut Illuminated Extension

Fixture Options: MOD Options

- Specify **MOD** in the part number for any of the below options
- Consult factory for **MOD** specification details, pricing, and lead-time information

MOD	Remote Driver
------------	---------------



Controls: Tunable White

- Pinnacle Lighting offers easy to specify tunable white solutions for integrated building control or standalone controls
- Pinnacle Lighting fixtures ship technology ready; commissioning by others
- Controls can only be used with Single Circuit (1) or Emergency Circuit (E),
- Contact factory for any non-standard configurations for layout or placement

	Solution	Components	Network/Sensor	Connection	Required-Drivers	Required-LED	Required-Controls	Limitations
B3LM	Legrand Wattstopper Blanco 3	BLM3-DLM	Digital Lighting Management (DLM)	Wired, two RJ45 ports	EC2	TW3	B3LM	Not available with 347 volt

Controls: MOD Options

- Specify **MOD** in the part number for any of the below options
- Control** Options may require specific driver. Refer to the chart below
- Consult factory for **MOD** specification details, pricing, and lead-time information

	Required Driver
MOD Enlighted (Wireless) - ENLI	Any 0-10v
Enlighted (Wireless) - ENLC	Any 0-10v
Encelium Sensilum	OD1, OL5
Legrand Wattstopper DLM	OL2, OL4
Acuity nLight Air Wireless Connected	EE6, ES6

Photometrics

Satine Lens

Test #	91432, 93985 ¹
Catalog #	EV3D-A-840VHO-4
Lumens	4020 lm
Watts	32.3 w
Efficacy	124.6 LPW

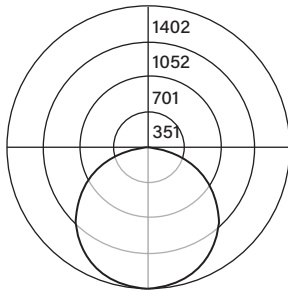

Candela Distribution

Vert Angle	Horizontal Angle				
	0	22.5	45	67.5	90
0	1400	1400	1400	1400	1400
5	1393	1395	1397	1398	1399
15	1348	1344	1350	1350	1348
25	1253	1245	1253	1254	1247
35	1112	1104	1112	1108	1105
45	940	932	935	932	930
55	734	730	730	729	727
65	507	504	503	501	503
75	269	268	271	273	274
85	65	66	70	73	73
90	0	0	0	0	0

Luminance Data (cd/sq.m)

Angle In Degrees	Average 0-Deg	Average 45-Deg	Average 90-Deg
45	10950	10892	10833
55	10541	10483	10440
65	9882	9804	9804
75	8561	8625	8720
85	6143	6616	6899

¹Based on ITL Reports 91432 and 93985.

For all available IES files, please visit our website at pinnacle-ltg.com. Photometry testing in accordance to IESNA-LM-79-08 at an NVLAP accredited testing laboratory. Testing conducted at 25°C ambient conditions.

Specifications and dimensions subject to change without notice. Specification sheets that appear on pinnacle-ltg.com are the most recent version and supersede all other previously printed or electronic versions.



Applications & Certificates

Housing: Formed cold-rolled 18 gauge steel housing. Highly reflective die-formed white painted steel reflector.

Shielding: Diffuse snap-in acrylic lens, removable for maintenance.

Mounting: EDGE is designed to install into acoustical grid and inaccessible ceilings. Specify GXG, FLF, SFS, NFN for individual, unjoinable units (individual units will fall on-grid). Specify GX, FL, SF, NF for continuous runs (runs designed to fall on-grid). Consult factory for detailed installation instructions. Maximum fixture weight is 15lbs per 4' fixture.

LED: 25°C test environment. Lumen output/wattage has a margin of +/- 5%; 2' or 3' lengths may have a greater wattage deviation. All luminaire configurations tested in accordance with IES LM-79. Diodes tested in accordance with IES LM-80. Lifetime calculated using IES TM-21. Minimum lifetime greater than 60,000 hours. Lifetime Projection L70 = 121,600 hours and L90 = 36,200 hours. MacAdam 3-Step Ellipses. Not all products are Lighting Facts listed. For all available IES files, please visit our website at pinnacle-ltg.com.

BIOS LED: Spectrum focused lighting for circadian stimulus. EML or M/P ratio: .8 for 3500K, .9 for 4000K. COI >3.0. Not all lumen packages available. Two lumen packages available. Standard, and High (HO). Custom outputs are available. Specify custom lumens or watts between standard offering listed on CRI, CCT & Output page.

CRI, CCT & Lumen Output: Three lumen packages available. Standard, High (HO) and Very High (VHO). Custom outputs are available. Specify custom lumens or watts between standard offering listed on CRI, CCT & Output page. 80 CRI is available for 3000K, 3500K, and 4000K. 90 CRI is available for 2700K, 3000K, 3500K, and 4000K. 80 CRI = R9≥19 and 90 CRI = R9≥61.

Voltage: Universal (U), 120 volt (1), 277 volt (2) and 347 volt (3) options available. Must specify OL4 in Driver section when 347 volt (3) is selected. Some EDGE configurations will not accommodate all voltage options; consult with factory.

Driver: Standard Driver Option is Advance Xitanium 0-10V, 1% = PL2. Electronic driver, power factor is >0.9 with a THD <20%. Driver Lifetime: 50,000 hours at 25°C ambient operating conditions. Ambient operating range: -20°F/-30°C to 98°F/37°C. For more driver options, see Pinnacle Resource Guide. Some EDGE configurations will not accommodate all driver options.

Circuiting: Select from single circuit (1), Multi circuit - For multiple circuiting and zone control, requires factory shop drawing (M), Emergency circuit (E), Life Safety (L) or Night Light circuit (N). For emergency circuiting situations that require no through wire or circuit separation, Life Safety Circuit should be selected. This will provide a separate power feed and only the Life Safety Circuit in that section. Some EDGE configurations will not accommodate all circuiting options; consult with factory.

Battery & Emergency: Select battery or emergency options if required. If battery or emergency option is not required, enter 0. Battery duration is 90 minutes as standard. Test button is remote to fixture. For more Battery options, see Pinnacle Resource Guide.

Finish: Standard powder-coat textured white, metallic silver, textured black, graphite or bronze painted finish; consult factory for chip of standard paint finishes or for additional custom color and finish options.

Controls: (B3LM) Wattstopper control of Intensity and CCT for tunable white, allows simple integration into a Wattstopper DLM control system. Blanco 3 offers the highest quality tunable white by mixing three channels of white LEDs for precise black body curve CCT. Uses constant voltage LED driver (EC2), BLM and Blanco 3 channel LED arrays (TW3).

Labels: UL and cUL Listed. Standard, HO and VHO lumen packages are IC Rated, approved for dry/damp location unless otherwise noted.

Fixture Weight: Maximum fixture weight is 15lbs per 4' fixture.

Buy American Act Compliant

Warranty: EDGE LED offered with a 5-year limited warranty. Covers LED, driver and fixture.