

# CHUTE CDSR

## Open Linear Direct Suspended to Recessed

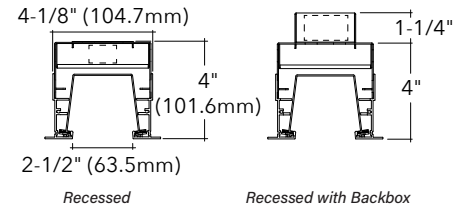

### Key Features

- Suspended to Recessed open aperture fixture
- Suspended: 6063-T6 Extruded aluminum housing
- Recessed: Extruded aluminum trim with formed cold rolled 18 gauge steel housing and back box
- 4" wide suspended fixture with a 2 1/2" fully luminous aperture
- Small, integral driver option for quick, easy installation
- Light Protection Guard (LPG) covers LEDs for optimal performance
- Four distinct decorative endcaps for tailored designs on suspended end
- 5-year limited warranty covers LED, driver and fixture
- ETL listed conforming to UL 1598 in US and CSA 250 in Canada
- Buy American Act compliant



Example Part #: CDSR-N-830HO-26'-AC48G1/SF8-1-EL1-1-0-W-AT

### CDSR- N

HOUSING    INDIRECT SHIELDING    CRI, CCT & OUTPUT    LENGTH    MOUNTING    VOLTAGE    DRIVER    CIRCUITING    BATTERY & EMERGENCY    FINISH    ENDCAPS    FIXTURE OPTIONS    CONTROLS

|   |  |   |  |     |     |     |     |     |     |     |     |              |
|---|--|---|--|-----|-----|-----|-----|-----|-----|-----|-----|--------------|
| <b>N</b>  | -----  | ---   | ---  | --- | --- | --- | --- | --- | --- | --- | --- | --- / SF --- |
| <b>INDIRECT SHIELDING</b>   | <b>CRI, CCT &amp; OUTPUT<sup>1</sup></b>   | <b>LENGTH<sup>2</sup></b>   | <b>MOUNTING<sup>3</sup></b>  |     |     |     |     |     |     |     |     |              |
| N - None  | <b>_27_</b> - 2700K<br><b>_30_</b> - 3000K<br><b>_35_</b> - 3500K<br><b>_40_</b> - 4000K<br><b>CL</b> - Custom Lumens<br><b>CW</b> - Custom Watts<br><i>CRI, CCT &amp; Output pg. 2</i>  | <b>_</b> - Continuous Row<br><i>(Specify overall length of row, this will include both recessed and suspended sections. Recessed only specified in Mounting section)</i><br><i>Length pg. 2</i> | <b>Suspended Mounting</b><br><b>AC_G</b> - AC to Grid<br><b>AC_JB</b> - AC to J Box<br><b>AC_ST</b> - AC to Structure<br><b>Recessed Mounting</b><br><b>SF</b> - Spackle Flange<br><i>(Specify Recessed length, example 8' length is SF8)</i><br><i>Mounting pg. 3</i>   |     |     |     |     |     |     |     |     |              |
| <b>VOLTAGE</b>  | <b>DRIVER</b>  | <b>CIRCUITING<sup>4</sup></b>   | <b>BATTERY &amp; EMERGENCY<sup>5</sup></b>   |     |     |     |     |     |     |     |     |              |
| <b>U</b> - Universal (120 thru 277V, remote)<br><b>1</b> - 120V<br><b>2</b> - 277V<br><b>3</b> - 347V (remote)<br><i>Voltage pg. 3</i>  | <b>Integral Driver / 4" Recessed Housing</b><br><b>EL1</b> - ERP Power (1%, 0-10v, 120v or 277v)<br><b>Remote Drivers / Recessed with Backbox</b><br><b>FSD</b> - Factory Select Driver (1%, 0-10v)<br><b>PL2</b> - Advance Xitanium (1%, 0-10v)<br><b>OL2</b> - Osram (1%, 0-10v)<br><b>OL4</b> - Osram 347v (1%, 0-10v)<br><b>EE1</b> - eldoLED ECOdrive (1%, 0-10v)<br><b>ES1</b> - eldoLED SOLOdrive (0%, 0-10v)<br><b>LH1</b> - Lutron Hi-lume (1%, EcoSystem)<br><i>Driver pg. 4</i> | <b>1</b> - Single Circuit<br><b>M</b> - Multi Circuit<br><b>E</b> - Emergency (entire fixture)<br><b>N</b> - Night Light (entire fixture)<br><i>Circuiting pg. 4</i>                            | <b>0</b> - None<br><b>_FSG</b> - Factory Select ALCR<br><b>_GI</b> - Iota ETS DR<br><b>_GB</b> - Bodine GTD<br><b>_PLL</b> - Bodine 10W (remote)<br><b>_ILL</b> - Iota 10W (remote)<br><b>_E</b> - Emergency Section<br><b>_N</b> - Night Light Section<br><b>_L</b> - Life Safety Section<br><i>Battery &amp; Emergency pg. 5</i> |     |     |     |     |     |     |     |     |              |
| <b>FINISH</b>   | <b>SUSPENDED ENDCAP</b>  | <b>FIXTURE OPTIONS</b>  | <b>CONTROLS</b>  |     |     |     |     |     |     |     |     |              |
| <b>W</b> - White<br><b>S</b> - Metallic Silver<br><b>BL</b> - Textured Black<br><b>BR</b> - Bronze<br><b>GR</b> - Graphite<br><b>CC</b> - Custom Color<br><i>Finish pg. 5</i> | <b>FE</b> - Flat Endcap<br><b>IB</b> - Inward Bevel Endcap<br><b>OB</b> - Outward Bevel Endcap<br><b>AT</b> - Angled Twist Endcap<br><i>Endcaps pg. 5</i>  | <b>CP</b> - Chicago Plenum<br><i>Fixture Options pg. 5</i>  | <i>Pinnacle is able to accommodate different control solutions from different manufacturers. Consult Factory for more information.</i>   |     |     |     |     |     |     |     |     |              |

<sup>1</sup>When specifying CRI, CCT & OUTPUT the first \_ is for specifying either 8 - 80CRI or 9 - 90CRI. The ending \_ are for specifying output, example HO - High Output. See output charts for more information. <sup>2</sup>Length must be specific in 1' increments. <sup>3</sup>When specify cable length standard AC is 48', 120" or 240". When Specifying grid for AC\_G use one of the following: G1=15/16", G9=9/16" or GS=Screw Slot. Example: AC48G1. When specifying spackle flange section use the " \_ " to enter the recessed length. Recessed sections can be specified in 1' increments, and will be a section from the total length specified in the length. Recessed non joined end will have closed endcap. <sup>4</sup>No through wire will be provided between suspended and recessed fixtures. <sup>5</sup>All Battery & Emergency options are REMOTE. Enter quantity for Battery and Emergency, Example 2P.

Specifications and dimensions subject to change without notice. Specification sheets that appear on pinnacle-ltg.com are the most recent version and supersede all other previously printed or electronic versions.



## CRI, CCT & Output

- 80 CRI = R9≥5, 90 CRI = R9≥61

### Custom Output - Lumens OR Wattage

|                 |   |   |
|-----------------|---|---|
| <b>CL</b> _____ | Specify CRI, CCT and desired lumens (i.e. CL835500) | <i>Specify lumens between standard offering listed below. Lumens are specified per color temp</i> |
| <b>CW</b> _____ | Specify CRI, CCT and desired wattage (i.e. CW9407)  | <i>Specify watts between standard offering listed below</i>                                       |

### 80 CRI

|               | Color | Output <sup>1</sup> |     |          |
|---------------|-------|---------------------|-----|----------|
|               |       | Lumens/ft           | LPW | Watts/ft |
| <b>830</b>    | 3000K | 500                 | 115 | 4.3      |
| <b>830HO</b>  | 3000K | 750                 | 116 | 6.5      |
| <b>830VHO</b> | 3000K | 1000                | 116 | 8.6      |
| <b>835</b>    | 3500K | 500                 | 123 | 4.1      |
| <b>835HO</b>  | 3500K | 750                 | 124 | 6.0      |
| <b>835VHO</b> | 3500K | 1000                | 125 | 8.0      |
| <b>840</b>    | 4000K | 500                 | 128 | 3.9      |
| <b>840HO</b>  | 4000K | 750                 | 128 | 5.9      |
| <b>840VHO</b> | 4000K | 1000                | 128 | 7.8      |

### 90 CRI (longer lead times may apply, consult factory)

|               |       |      |     |      |
|---------------|-------|------|-----|------|
| <b>927</b>    | 2700K | 500  | 97  | 5.2  |
| <b>927HO</b>  | 2700K | 750  | 97  | 7.7  |
| <b>927VHO</b> | 2700K | 1000 | 100 | 10.0 |
| <b>930</b>    | 3000K | 500  | 105 | 4.8  |
| <b>930HO</b>  | 3000K | 750  | 105 | 7.1  |
| <b>930VHO</b> | 3000K | 1000 | 106 | 9.4  |
| <b>935</b>    | 3500K | 500  | 110 | 4.6  |
| <b>935HO</b>  | 3500K | 750  | 110 | 6.8  |
| <b>935VHO</b> | 3500K | 1000 | 111 | 9.0  |
| <b>940</b>    | 4000K | 500  | 107 | 4.7  |
| <b>940HO</b>  | 4000K | 750  | 107 | 7.0  |
| <b>940VHO</b> | 4000K | 1000 | 108 | 9.3  |

<sup>1</sup>LPW and watts/ft based off 48" fixture size.

## Length

- Length must be specified in 1' increments
- Recessed length is to the foot. Example 8' = 96"
- For Standard Flat end cap adds 5/16" (7.6mm) to the overall length of the row.
- For Inward Bevel end cap adds 13/32" (10.1mm) to the overall length of the row.
- For Outward Bevel end cap adds 23/32" (18.4mm) to the overall length of the row.
- For Angled Twist end cap adds 1/2" (12.6mm) to the overall length of the row.
- See page 4 for endcap details.
- Consult factory for additional lengths.

### Continuous Run

Specify nominal overall row length. Lengths must be in 1' increments.

### Specify Overall Length

Fixture lengths do not include endcap dimensions. See bullet points listed above for each endcap. Example: 2' fixture (24") + 1 Standard Flat Endcap (5/16") = 24 5/16" overall.

### Length Breakdown

- Specified Length: 16' - Mounting: AC48G1/SF8 = 16' overall, 8' Suspended & 8' Recessed

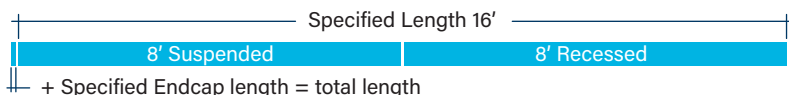



## Suspended Mounting

- Specify cable length in ordering code (AC48G1)
- Standard specifiable lengths are 48", 120", 240" and 350"
- End plates and power cord attached at factory
- Aircraft cable (AC) mounts on 4' (1219.2mm) and 8' (2438.4mm) centers
- Aircraft Cable supplied with 5" (127mm) power and 2" (50.8mm) non-power canopies
- Canopies are painted to match fixture finish, power cords are white, grey, or black depending on fixture finish. See Finish section for additional details

- Approved for dry/damp location unless otherwise noted
- Refer to installation instructions during installation at the job site
- Maximum fixture weight is 20 lbs for a standard 4' fixture
- Remote box will be included for all specifications that include batteries, GTD, or a driver OTHER THAN the EL1. See Installation Instructions for more specific information about mounting
- For integral driver version, access for wiring and drivers through the indirect side of the fixture only

|               |  |
|---------------|--|
| <b>AC_G1</b>  | Aircraft Cable 1" (15/16") T-Bar           |
| <b>AC_G9</b>  | Aircraft Cable 9/16" T-Bar                 |
| <b>AC_GS</b>  | Aircraft Cable Screw Slot T-Bar            |
| <b>AC_JB</b>  | Aircraft Cable Junction Box                |
| <b>AC_ST</b>  | Aircraft Cable Structure                   |
| <b>AC5_G</b>  | Aircraft Cable 5" (127mm) Non-Power Canopy |
| <b>AC5_JB</b> | Aircraft Cable 5" (127mm) Non-Power Canopy |
| <b>SQ_G</b>   | Aircraft Cable 5" (127mm) Square Canopy    |
| <b>SQ_JB</b>  | Aircraft Cable 5" (127mm) Square Canopy    |

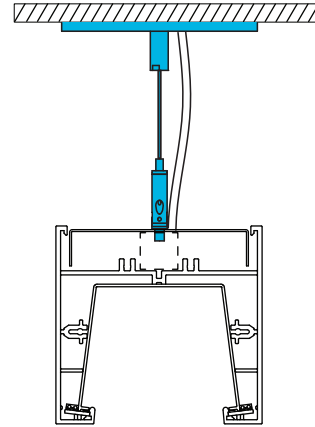

AC - Single,  
Adjustable AC Cable

## Recessed Mounting

- Continuous Units, specify, SF\_\_
- Use "\_\_" to specify recessed length in 1' increments

- Designed to install into inaccessible ceilings
- Approved for dry/damp location unless otherwise noted

**SF\_\_**  
Drywall,  
Flangeless Detail  
Flange to Flange:  
6" (152.4mm)

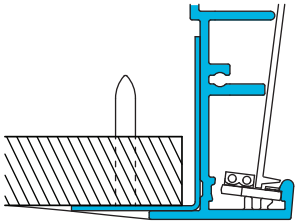

## Voltage

- Some CHUTE configurations will not accommodate all voltage options; consult with factory
- For EL1 driver, must specify 120v or 277v

|          |                    |
|----------|--------------------|
| <b>U</b> | Universal (remote) |
| <b>1</b> | 120 volt           |
| <b>2</b> | 277 volt           |
| <b>3</b> | 347 volt (remote)  |



## Driver

- Standard Driver Option = EL1
- Driver Lifetime: 50,000 hours at 25°C ambient operating conditions
- For more driver options, see Pinnacle Resource Guide
- Some CHUTE configurations will not accommodate all driver options; consult with factory
- On suspended fixtures, EL1 driver is integral to the fixture housing. Remote box necessary for all drivers OTHER THAN the EL1
- On recessed fixtures, EL1 driver is in a 4" housing. Deeper 5 1/4" necessary for all drivers OTHER THAN the EL1
- Osram and Lutron Drivers have a remote distance limitation of 10'
- eldoLED and Advance Drivers have an average remote distance limitation of 50'. Consult Factory for specific configurations

Slim Remote Box

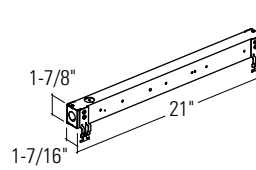

Standard Remote Box

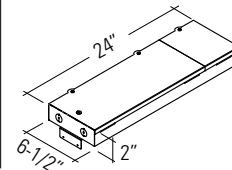

## Integral Driver/ 4" Recessed Housing

**EL1** ERP Power 1%, 0-10v, requires 120 or 277

## Remote Driver/ Recessed with Back Box

### 0-10V Drivers

|            |   |
|------------|---|
| <b>FSD</b> | Factory Select Driver (1%, 0-10v)                     |
| <b>PL2</b> | Signify Advance Xitanium 1%, 0-10v                    |
| <b>PL4</b> | Advance Xitanium 347v 1%, 0-10v, requires 347v        |
| <b>OL2</b> | Osram Optotronic, 1%, 0-10v                           |
| <b>OL4</b> | Osram Optotronic 347v, 1% 0-10v, requires 347v option |
| <b>EE1</b> | eldoLED ECOdrive 1%, 0-10v Logarithmic                |
| <b>ES1</b> | eldoLED SOLOdrive 0-10v, 0% Logarithmic               |

### DALI Drivers

|            |   |
|------------|---|
| <b>EE3</b> | eldoLED SOLOdrive .1%, DALI (logarithmic) |
| <b>EE4</b> | eldoLED SOLOdrive .1%, DALI (linear)      |
| <b>OD1</b> | Osram Optotronic 1%, DEXAL                |
| <b>OD2</b> | Osram Optotronic 1%, DALI 2 Channel       |

### Lutron Drivers

|            |   |
|------------|---|
| <b>LH1</b> | Lutron Hi-lume Soft-on, Fade-to-black 1%, EcoSystem, LDE1 |
| <b>LH4</b> | Lutron Hi-Lume 1%, 2-wire, Lutron-LTEA2W, 120v only       |

### Alternate Drivers

|            |                                |
|------------|--------------------------------|
| <b>EH1</b> | ELV 120v only, 0-10v universal |
|------------|--------------------------------|

## Slim Remote Box

Standard Output (STD),  
High Output (HO)

All Configurations

All Configurations

## Standard Remote Box

Very High Output (VHO), 90CRI  
Options

Very High Output (VHO), 90CRI  
Options

N/A

N/A

## How to specify Circuiting, Battery

- Select fixture circuiting from options below
  - Some CHUTE configurations will not accommodate all circuiting options, consult with factory

## Circuiting

|          |                          |
|----------|--------------------------|
| <b>1</b> | Single Circuit           |
| <b>M</b> | Multi Circuit            |
| <b>E</b> | Emergency Circuit only   |
| <b>N</b> | Night Light Circuit only |

- Battery and emergency section options are available in addition to fixture circuit
  - Select battery and emergency section options below; factory shop drawing required
  - Some CHUTE configurations will not accommodate all circuiting options, consult with factory



## Battery and/or Emergency If Required

**0** No battery or specific emergency section required

### Battery

- Battery is REMOTE or in RECESSED BACK BOX
- Select battery section type if required, indicate total QTY. *Example 2PL*
- 90 minute battery runtime; test button is remote to fixture and requires an additional drop
- Entire fixture housing is on battery for 2' and 4' lengths
- 4' of fixture is on battery for 6' or 8' housing lengths
- PLL and ILL not available with VHO and 927HO
- For more battery options available, see [Pinnacle Resource Guide](#)

#### For Approximate Battery Lumen Output

- Multiply battery wattage X fixture LPW shown on Lumen Table
- 92.3 (LPW) x 10 (watts) = 923 battery lumen output

|             |   |
|-------------|---|
| <b>0</b>    | No Battery                                |
| <b>_ILL</b> | Iota 10w Integral Lithium, Self Testing   |
| <b>_IRC</b> | Iota 10w Remote                           |
| <b>_IRH</b> | Iota 20w Remote                           |
| <b>_PLL</b> | Bodine 10w Integral Lithium, Self Testing |
| <b>_PRL</b> | Bodine 7w Remote                          |
| <b>_PRS</b> | Bodine 7w Remote, Self Testing            |
| <b>_PRD</b> | Bodine 10w Remote, Dual Flex              |
| <b>_PRH</b> | Bodine 20w Remote                         |

## How to specify Emergency

### Emergency

- GTD is REMOTE
- Select emergency type if required, indicate total QTY. *Example 1E*
- Emergency available in 4' increments
- Combine battery and emergency ordering codes if both options are selected

|             |   |
|-------------|---|
| <b>_FSG</b> | Factory Select ALCR, Automatic Load Control Relay |
| <b>_GI</b>  | Iota ETS DR, Emergency Lighting Control Device    |
| <b>_GB</b>  | Bodine GTD, Emergency Lighting Control Device     |
| <b>_E</b>   | Emergency circuit                                 |
| <b>_N</b>   | Night Light circuit                               |
| <b>_L</b>   | Life Safety circuit section NO THROUGH WIRE       |

#### Battery OR Emergency Ordering Examples

- Single circuit, 10w Integral Battery      Ordering Code: 1-1PLL
- Emergency only, 10w Integral Battery      Ordering Code: E-1PLL
- Single circuit, GTD required      Ordering Code: 1-1G

#### Combination Section Ordering Examples

- Single circuit, (1) 10w battery, (1) emergency      Ordering Code: 1-1PLL1E
- Multi circuit, (2) 10w battery, (2) emergency      Ordering Code: M-2PLL2E
- Single circuit, (1) night light      Ordering Code: 1-1N

## Finish

- Standard powder-coat textured white, metallic silver, textured black, graphite or bronze painted finish; consult factory for chip of standard paint finishes
- Selecting a fixture finish other than white may impact lumen output; consult factory for more information

|           |   |
|-----------|---|
| <b>W</b>  | White ( <i>white cord/white canopy</i> )              |
| <b>S</b>  | Metallic Silver ( <i>grey cord/silver canopy</i> )    |
| <b>BL</b> | Textured Black ( <i>black cord/black canopy</i> )     |
| <b>BR</b> | Bronze ( <i>white cord/bronze canopy</i> )            |
| <b>GR</b> | Graphite ( <i>white cord/graphite canopy</i> )        |
| <b>CC</b> | Custom Color ( <i>white cord/color match canopy</i> ) |

## Endcaps

- Endcap MUST be specified.

|           |                      |
|-----------|----------------------|
| <b>FE</b> | Flat Endcap          |
| <b>IB</b> | Inward Bevel Endcap  |
| <b>OB</b> | Outward Bevel Endcap |
| <b>AT</b> | Angled Twist Endcap  |

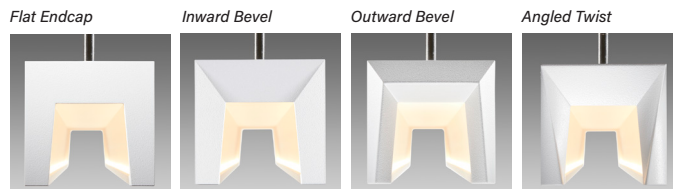



## Fixture Options

- Additional options to enhance the fixture and finish of the product

**CP** Chicago Plenum, applies to recessed fixtures and all necessary remote boxes

## Controls

- Pinnacle is able to accommodate different control solutions from different manufacturers. Consult Factory for more information.

## Photometrics

### Open

Test # ITL93-69  
 Catalog # CD-N-835VHO  
 Lumens 4219 lm  
 Watts 34.5 W  
 Efficacy 122 LPW

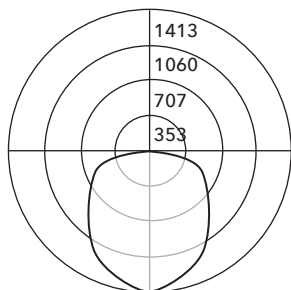

### Candela Distribution

| Vert Angle | Horizontal Angle |      |      |      |      |
|------------|------------------|------|------|------|------|
|            | 0                | 22.5 | 45   | 67.5 | 90   |
| 0          | 1411             | 1411 | 1411 | 1411 | 1411 |
| 5          | 1410             | 1394 | 1397 | 1393 | 1386 |
| 10         | 1395             | 1369 | 1360 | 1347 | 1337 |
| 15         | 1369             | 1332 | 1311 | 1292 | 1280 |
| 20         | 1335             | 1285 | 1256 | 1228 | 1215 |
| 25         | 1289             | 1229 | 1191 | 1157 | 1141 |
| 30         | 1234             | 1164 | 1117 | 1075 | 1055 |
| 35         | 1169             | 1093 | 1037 | 986  | 964  |
| 40         | 1095             | 1014 | 946  | 891  | 869  |
| 45         | 1010             | 927  | 850  | 798  | 782  |
| 50         | 918              | 833  | 751  | 722  | 716  |
| 55         | 816              | 733  | 661  | 656  | 656  |
| 60         | 709              | 627  | 585  | 598  | 603  |
| 65         | 593              | 521  | 517  | 545  | 552  |
| 70         | 476              | 421  | 456  | 492  | 500  |
| 75         | 357              | 341  | 397  | 427  | 428  |
| 80         | 235              | 272  | 322  | 299  | 272  |
| 85         | 121              | 193  | 111  | 61   | 46   |
| 90         | 31               | 60   | 40   | 18   | 0    |

### Luminance Data (cd/sq.m)

| Angle In Degrees | Average 0-Deg | Average 45-Deg | Average 90-Deg |
|------------------|---------------|----------------|----------------|
| 45               | 17498         | 8801           | 7048           |
| 55               | 17058         | 7119           | 5990           |
| 65               | 16247         | 5991           | 5270           |
| 75               | 14843         | 5147           | 4422           |
| 85               | 11127         | 1692           | 536            |

## Applications & Certificates

**Construction:** Suspended: 6063-T6 Extruded aluminum housing. Highly reflective coextruded acrylic reflector with LED protection guard. Recessed: Extruded aluminium rails and formed cold-rolled 18 gauge steel housing. Highly reflective coextruded acrylic reflector with LED protection guard.

**Mounting:** CHUTE Recessed is designed to install into inaccessible ceilings. Specify SF for continuous runs. Maximum recessed fixture weight is 15lbs per 4' fixture. CHUTE Suspended Aircraft cable mounting. Straight aircraft cable that mounts on 4'-0" (1219.2mm) and 8'-0" (2438.4mm) centers. Aircraft Cable supplied with 5" (127mm) power and 2" (50.8mm) non-power canopies. Refer to installation instructions for appropriate ceiling detail. Canopies are painted white unless otherwise specified. Maximum suspended fixture weight is 25 lbs. for a standard 4' fixture. Fixture can only be mounted perpendicular to bulk head.

**LED:** 25°C test environment. Lumen output/wattage has a margin of +/- 5%; 2' lengths may have a greater wattage deviation. All luminaire configurations tested in accordance with IES LM-79. Diodes tested in accordance with IES LM-80. Lifetime calculated using IES TM-21. Minimum lifetime greater than 60,000 hours. L70 = 146,500 hours and L90 = 45,100 hours. MacAdam 3-Step Ellipses. For all available IES files, please visit our website at pinnacle-ltg.com.

**CRI, CCT & Output:** Three lumen packages available. Standard, High (HO), and Very High (VHO). Custom outputs are available. Specify custom lumens or watts between standard offering listed on CRI, CCT & Output page. 80 CRI is available for 3000K, 3500K, and 4000K. 90 CRI is available for 2700K, 3000K, 3500K, and 4000K. 80 CRI = R9≥5 and 90 CRI = R9≥61.

**Voltage:** Universal (U), 120 volt (1), 277 volt (2) and 347 volt (3) options available. Must specify OL4 in Driver section when 347 volt (3) is selected. Some CHUTE configurations will not accommodate all voltage options; consult with factory.

**Driver:** CHUTE Recessed: Standard INTEGRAL Driver Option is EL1. All other driver options will be in driver backbox. CHUTE Suspended: Standard INTEGRAL Driver Option is EL1. All other driver options will be in remote box. EL1 designed for use with 120v or 277v only. Electronic driver, Power factor is >0.9 with a THD <20%. Driver Lifetime: 50,000 hours at 25°C ambient operating conditions. Ambient operating range: -20°F/-30°C to 128°F/54°C. When ND is specified, a spec grade driver will be provided. For more driver options, see Pinnacle Resource Guide. Some CHUTE configurations will not accommodate all driver options.

### Suspended Section - Remote Box Mounting Guide (Advance & eldoLED)

Distance limited by max input watts shown, Direct & Indirect should be calculated separately

| Max Distance | 142'    | 107'    | 71'     | 50'     | 37'   |
|--------------|---------|---------|---------|---------|-------|
| 4' Housing   | 4.9w/ft | 6.4w/ft | 9.5w/ft | 13w/ft  | N/A   |
| 8' Housing   | N/A     | 3.1w/ft | 4.8w/ft | 6.9w/ft | 9w/ft |

**Circuiting:** Select from single circuit (1), Multi circuit (M), Emergency circuit (E) or Night Light circuit (N). For emergency circuiting situations that require no through wire or circuit separation, Life Safety Circuit should be selected. This will provide a separate power feed and only the Life Safety Circuit in that section. Some CHUTE configurations will not accommodate all circuiting options, consult with factory.

**Battery & Emergency:** Select battery or emergency options if required. If battery or emergency option is not required, enter 0. Battery duration is 90 minutes as standard. Test button is remote to fixture. For more Battery options, see Pinnacle Resource Guide.

**Finish:** Standard powder-coat textured white, metallic silver, textured black, graphite or bronze painted finish; consult factory for chip of standard paint finishes. Canopies painted to match fixture specified fixture finish. Contact factory for additional custom color and finish options.

**Controls:** Pinnacle is able to accommodate different control solutions from different manufacturers. Consult Factory for more information.

**Labels:** ETL listed conforming to UL 1598 in US and CSA 250 in Canada. Approved for dry/damp location unless otherwise noted.

**Fixture Weight:** Maximum fixture weight is 20 lbs. for a standard 4' fixture.

### Buy American Act Compliant

**Warranty:** CHUTE LED offered with a 5-year limited warranty. Covers LED, driver and fixture.