

# LINERO L8DI-A

## Single Source Linear

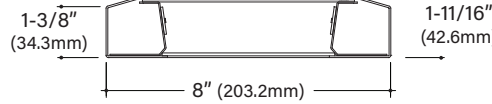

### Key Features

- One piece die-formed 18 gauge steel housing
- Highly reflective die-formed white painted steel reflector
- Die-cast aluminum end caps
- LINERO offered with a 5-year limited warranty that covers LED, driver and fixture
- UL and cUL Listed
- Approved for dry/damp location
- Maximum fixture weight is 17 lbs per standard 4' fixture
- Room-Side Maintenance for LED system
- Buy American Act compliant



QUICKSHIP



Example Part #: L8DI-A-70v-835HO-26'-AC48G1-U-OL2-1-0-W





L8DI-A	---	-----	---
HOUSING	DISTRIBUTION	CRI, CCT & OUTPUT <sup>QS</sup> <sub>1</sub>	LENGTH <sup>2</sup>
<b>L8DI-A</b> - LINERO 8 with Satine Lens <sup>QS</sup> <i>Shielding pg. 2</i>	<b>40</b> - 40% Direct / 60% Indirect <sup>QS</sup> <b>70</b> - 70% Direct / 30% Indirect <sup>QS</sup> <b>100</b> - 100% Direct <sup>QS</sup> <i>Shielding pg. 2</i>	<b>_27_</b> - 2700K <b>_30_</b> - 3000K <b>_35_</b> - 3500K ( <i>available with BIOS</i> ) <b>_40_</b> - 4000K ( <i>available with BIOS</i> ) <b>CL</b> - Custom Lumens <b>CW</b> - Custom Watts <i>Lumen Output pg. 2-5</i>	<b>_ _</b> - Individual Fixture <sup>QS</sup> <b>_ _</b> - Continuous Row <sup>QS</sup> <i>Length pg. 5</i>
---	---	---	---
MOUNTING <sup>3</sup>	VOLTAGE	DRIVER	CIRCUITING
<b>AC_ _G_</b> - AC to Grid <sup>QS</sup> <b>AC_ _JB</b> - AC to J Box <sup>QS</sup> <b>AC_ _ST</b> - AC to Structure <sup>QS</sup> <b>AC5_ _G_</b> - 5" Non-Power Canopy <b>AC5_ _JB</b> - 5" Non-Power Canopy <b>SQ_ _G_</b> - 5" Square Canopy <b>SQ_ _JB</b> - 5" Square Canopy <b>WA</b> - Wall Mount <i>Mounting pg. 5</i>	<b>U</b> - Universal <sup>QS</sup> <i>(120 thru 277V)</i> <b>1</b> - 120V <sup>QS</sup> <b>2</b> - 277V <sup>QS</sup> <b>3</b> - 347V <i>Voltage pg. 6</i>	<b>PL2</b> - Advance Xitanium (1%, 0-10v) <sup>QS</sup> <b>OL5</b> - Osram (1%, 0-10v, AUX) <b>OL5</b> - Osram (1%, 0-10v, DEXAL) <b>EE1</b> - eldoLED ECOdrive (1%, 0-10v) <b>ES1</b> - eldoLED SOLOdrive (0%, 0-10v) <sup>QS</sup> <b>LH1</b> - Lutron Hi-lume (1%, EcoSystem) <sup>QS</sup> <b>L51</b> - Lutron 5-Series (5%, EcoSystem) <b>OL2</b> - Osram (1%, 0-10v) <sup>QS</sup> <b>ND</b> - Non-Dimming <sup>QS</sup> <i>Driver pg. 6</i>	<b>1</b> - Single Circuit <sup>QS</sup> <b>M</b> - Multi Circuit <b>E</b> - Emergency <sup>QS</sup> <i>(entire fixture)</i> <b>N</b> - Night Light <sup>QS</sup> <i>(entire fixture)</i> <i>Circuiting pg. 6</i>
---	---	---	---
BATTERY & EMERGENCY <sup>4</sup>	FINISH	FIXTURE OPTIONS <sup>QS</sup> <sub>5</sub>	CONTROLS <sup>6</sup>
<b>0</b> - None <sup>QS</sup> <b>_E</b> - Emergency circuit section <b>_N</b> - Night Light circuit section <b>_L</b> - Life Safety circuit section <b>_G</b> - Bodine GTD <b>_ILL</b> - Iota 10w Integral <b>_PLL</b> - Bodine 10w Integral Lithium <i>Battery and Emergency pg. 6</i>	<b>W</b> - White <sup>QS</sup> <b>S</b> - Metallic Silver <b>BL</b> - Textured Black <b>BR</b> - Bronze <b>GR</b> - Graphite <b>CC</b> - Custom Color <i>Finish pg. 7</i>	<b>QS</b> - Quick Ship <sup>QS</sup> <i>Fixture Options pg. 7</i>	<b>DLMFC</b> - Wattstopper DLM ( <i>wired</i> ) <b>EASYS</b> - Philips EasySense ( <i>wireless</i> ) <b>SNSLM</b> - Osram Sensilum ( <i>wireless</i> ) <b>WVLX</b> - Eaton WaveLinX ( <i>wireless</i> ) <b>VDO</b> - Lutron Vive Sensor ( <i>wireless</i> ) <b>VRF</b> - Lutron Vive Connected ( <i>wireless</i> ) <b>ENL</b> - Enlighted ( <i>wireless</i> ) <i>Controls pg. 7</i>

<sup>1</sup>When specifying SOURCE the first \_ is for specifying either **8** - 80CRI, **9** - 90CRI or **B** - BIOS. The ending \_ are for specifying output, example **HO** - High Output. When specifying BIOS use **B** and then specify color temperature, either 3500K or 4000K, and output, example **B35HO** - BIOS 3500K High Output. See output charts for more information. BIOS dynamic available, please contact factory for more information. For Quick-ship CRI, CCT & Output see chart on page 7 <sup>2</sup>Individual fixtures come in 4', 6' & 8' lengths. Continuous rows available in 2' increments, starting at 4'. <sup>3</sup>Specify AC Cable length, standard AC is 48"; Specify grid: G1=15/16", G9=9/16", GS=Screw Slot. Example AC48G1. <sup>4</sup>Enter quantity for Battery and Emergency, Example 2PL. <sup>5</sup>QS must be used in fixture options section of part number to qualify. 1/8" increments not available for QS. <sup>6</sup>Controls can only be used with Single Circuit (1) or Emergency Circuit (E). See Controls chart on page 6 for driver options and more information.

Specifications and dimensions subject to change without notice. Specification sheets that appear on pinnacle-ltg.com are the most recent version and supersede all other previously printed or electronic versions.



## Distribution

<b>40</b> 40% Direct / 60% Indirect	<b>70</b> 70% Direct / 30% Indirect	<b>100</b> 100% Direct
		

### 40% Direct Source: Static White<sup>1</sup>

- Specify either 80 or 90 CRI
- Longer lead-time may apply for 90 CRI. Consult factory
- 80 CRI = R9≥19 and 90 CRI = R9≥61

## Custom Output- Lumens OR Wattage

<b>CL</b> _____	Specify CRI, CCT and desired lumens (i.e. CL835950)	<i>Specify lumens between standard offering listed below. Lumens are specified per color temp</i>
<b>CW</b> _____	Specify CRI, CCT and desired wattage (i.e. CW9409.5)	<i>Specify watts between standard offering listed below</i>

### 80 CRI

	Color	Lumens <i>per foot</i>	Shielding	
			A Satine <i>Watts/ft</i>	LPW
<b>830LO</b>	3000K	400	2.6	154.7
<b>830</b>	3000K	600	3.8	159.0
<b>830HO</b>	3000K	850	5.4	157.8
<b>830VHO</b>	3000K	1250	8.0	157.0
<b>835LO</b>	3500K	400	2.6	154.7
<b>835</b>	3500K	600	3.8	159.0
<b>835HO</b>	3500K	850	5.4	157.8
<b>835VHO</b>	3500K	1250	8.0	157.0
<b>840LO</b>	4000K	400	2.6	154.7
<b>840</b>	4000K	600	3.8	159.0
<b>840HO</b>	4000K	850	5.4	157.8
<b>840VHO</b>	4000K	1250	8.0	157.0

### 90 CRI

<b>927LO</b>	2700K	400	2.6	154.7
<b>927</b>	2700K	600	3.8	159.0
<b>927HO</b>	2700K	850	5.4	157.8
<b>927VHO</b>	2700K	1250	8.0	157.0
<b>930LO</b>	3000K	400	2.6	154.7
<b>930</b>	3000K	600	3.8	159.0
<b>930HO</b>	3000K	850	5.4	157.8
<b>930VHO</b>	3000K	1250	8.0	157.0
<b>935LO</b>	3500K	400	2.6	154.7
<b>935</b>	3500K	600	3.8	159.0
<b>935HO</b>	3500K	850	5.4	157.8
<b>935VHO</b>	3500K	1250	8.0	157.0
<b>940LO</b>	4000K	400	2.6	154.7
<b>940</b>	4000K	600	3.8	159.0
<b>940HO</b>	4000K	850	5.4	157.8
<b>940VHO</b>	4000K	1250	8.0	157.0

<sup>1</sup>LPW and watts/ft based off 48" fixture size.

Specifications and dimensions subject to change without notice. Specification sheets that appear on pinnacle-ltg.com are the most recent version and supersede all other previously printed or electronic versions.



40% Direct Source: BIOS<sup>1</sup>

- CRI >84, R9 >90
- Spectrum focused lighting for circadian stimulus
- High EML or M/P ratio: .8 for 3500K, .9 for 4000K
- COI: ≤3.3
- Available for use with most Driver or Control options

Custom Output- Lumens OR Wattage

<b>CLB</b> _____	Specify CRI, CCT and desired lumens (i.e. CL835950)	Specify lumens between standard offering listed below. Lumens are specified per color temp
<b>CWB</b> _____	Specify CRI, CCT and desired wattage (i.e. CW9409.5)	Specify watts between standard offering listed below

80 CRI

	Color	Lumens <i>per foot</i>	Shielding <b>A</b> Satine	
			Watts/ft	LPW
<b>835LO</b>	3500K	400	4.3	93.6
<b>835</b>	3500K	600	6.5	93.0
<b>835HO</b>	3500K	850	9.4	90.8
<b>835VHO</b>	3500K	1250	14.3	87.2
<b>840LO</b>	4000K	400	4.3	93.0
<b>840</b>	4000K	600	6.3	95.5
<b>840HO</b>	4000K	850	9.1	93.3
<b>840VHO</b>	4000K	1250	14.0	89.6

70% Direct Source: Static White<sup>1</sup>

Custom Output- Lumens OR Wattage

<b>CL</b> _____	Specify CRI, CCT and desired lumens (i.e. CL835950)	Specify lumens between standard offering listed below. Lumens are specified per color temp
<b>CW</b> _____	Specify CRI, CCT and desired wattage (i.e. CW9409.5)	Specify watts between standard offering listed below

80 CRI

	Color	Lumens <i>per foot</i>	Shielding <b>A</b> Satine	
			Watts/ft	LPW
<b>830LO</b>	3000K	400	3.4	117.5
<b>830</b>	3000K	600	4.8	123.7
<b>830HO</b>	3000K	850	6.9	123.3
<b>830VHO</b>	3000K	1250	10.4	119.6
<b>835LO</b>	3500K	400	3.4	117.5
<b>835</b>	3500K	600	4.8	123.7
<b>835HO</b>	3500K	850	6.9	123.3
<b>835VHO</b>	3500K	1250	10.4	119.6
<b>840LO</b>	4000K	400	3.4	117.5
<b>840</b>	4000K	600	4.8	123.7
<b>840HO</b>	4000K	850	6.9	123.3
<b>840VHO</b>	4000K	1250	10.4	119.6

90 CRI

<b>927LO</b>	2700K	400	3.5	117.3
<b>927</b>	2700K	600	4.8	123.7
<b>927HO</b>	2700K	850	6.9	123.3
<b>927VHO</b>	2700K	1250	10.4	119.6
<b>930LO</b>	3000K	400	3.4	117.5
<b>930</b>	3000K	600	4.8	123.7
<b>930HO</b>	3000K	850	6.9	123.3
<b>930VHO</b>	3000K	1250	10.4	119.6
<b>935LO</b>	3500K	400	3.4	117.5
<b>935</b>	3500K	600	4.8	123.7
<b>935HO</b>	3500K	850	6.9	123.3
<b>935VHO</b>	3500K	1250	10.4	119.6
<b>940LO</b>	4000K	400	3.4	117.5
<b>940</b>	4000K	600	4.8	123.7
<b>940HO</b>	4000K	850	6.9	123.3
<b>940VHO</b>	4000K	1250	10.4	119.6

<sup>1</sup>LPW and watts/ft based off 48" fixture size.

Specifications and dimensions subject to change without notice. Specification sheets that appear on pinnacle-ltg.com are the most recent version and supersede all other previously printed or electronic versions.



70% Direct Source: BIOS<sup>1</sup>

Custom Output- Lumens OR Wattage

<b>CLB</b> _____	Specify CRI, CCT and desired lumens (i.e. CL835950)	<i>Specify lumens between standard offering listed below. Lumens are specified per color temp</i>
<b>CWB</b> _____	Specify CRI, CCT and desired wattage (i.e. CW9409.5)	<i>Specify watts between standard offering listed below</i>

80 CRI

	Color	Lumens <i>per foot</i>	Shielding <b>A</b>	
			Satine <i>Watts/ft</i>	<i>LPW</i>
<b>835LO</b>	3500K	400	5.2	77.6
<b>835</b>	3500K	600	7.9	76.1
<b>835HO</b>	3500K	850	11.5	73.7
<b>835VHO</b>	3500K	1250	17.8	70.2
<b>840LO</b>	4000K	400	5.0	79.7
<b>840</b>	4000K	600	7.7	78.2
<b>840HO</b>	4000K	850	11.2	75.8
<b>840VHO</b>	4000K	1250	17.3	72.2

100% Direct Source: Static White<sup>1</sup>

Custom Output- Lumens OR Wattage

<b>CL</b> _____	Specify CRI, CCT and desired lumens (i.e. CL835950)	<i>Specify lumens between standard offering listed below. Lumens are specified per color temp</i>
<b>CW</b> _____	Specify CRI, CCT and desired wattage (i.e. CW9409.5)	<i>Specify watts between standard offering listed below</i>

80 CRI

	Color	Lumens <i>per foot</i>	Shielding <b>A</b>	
			Satine <i>Watts/ft</i>	<i>LPW</i>
<b>830LO</b>	3000K	400	3.3	122.4
<b>830</b>	3000K	600	4.6	130.1
<b>830HO</b>	3000K	850	6.5	129.8
<b>830VHO</b>	3000K	1250	9.8	127.5
<b>835LO</b>	3500K	400	3.3	122.4
<b>835</b>	3500K	600	4.6	130.1
<b>835HO</b>	3500K	850	6.5	129.8
<b>835VHO</b>	3500K	1250	9.8	127.5
<b>840LO</b>	4000K	400	3.3	122.4
<b>840</b>	4000K	600	4.6	130.1
<b>840HO</b>	4000K	850	6.5	129.8
<b>840VHO</b>	4000K	1250	9.8	127.5

90 CRI

	Color	Lumens <i>per foot</i>	Shielding <b>A</b>	
			Satine <i>Watts/ft</i>	<i>LPW</i>
<b>927LO</b>	2700K	400	3.3	122.4
<b>927</b>	2700K	600	4.6	130.1
<b>927HO</b>	2700K	850	6.5	129.8
<b>927VHO</b>	2700K	1250	9.8	127.5
<b>930LO</b>	3000K	400	3.3	122.4
<b>930</b>	3000K	600	4.6	130.1
<b>930HO</b>	3000K	850	6.5	129.8
<b>930VHO</b>	3000K	1250	9.8	127.5
<b>935LO</b>	3500K	400	3.3	122.4
<b>935</b>	3500K	600	4.6	130.1
<b>935HO</b>	3500K	850	6.5	129.8
<b>935VHO</b>	3500K	1250	9.8	127.5
<b>940LO</b>	4000K	400	3.3	122.4
<b>940</b>	4000K	600	4.6	130.1
<b>940HO</b>	4000K	850	6.5	129.8
<b>940VHO</b>	4000K	1250	9.8	127.5

<sup>1</sup>LPW and watts/ft based off 48" fixture size.

Specifications and dimensions subject to change without notice. Specification sheets that appear on pinnacle-ltg.com are the most recent version and supersede all other previously printed or electronic versions.



100% Direct Source: BIOS<sup>1</sup>

## Custom Output- Lumens OR Wattage

<b>CLB</b> _____	Specify CRI, CCT and desired lumens (i.e. CL835950)	<i>Specify lumens between standard offering listed below. Lumens are specified per color temp</i>
<b>CWB</b> _____	Specify CRI, CCT and desired wattage (i.e. CW9409.5)	<i>Specify watts between standard offering listed below</i>

## 80 CRI

	Color	Lumens <i>per foot</i>	Shielding <b>A</b>	
			Satine <i>Watts/ft</i>	LPW
<b>835LO</b>	3500K	400	5.1	77.8
<b>835</b>	3500K	600	7.9	76.3
<b>835HO</b>	3500K	850	11.5	74.0
<b>835VHO</b>	3500K	1250	17.7	70.4
<b>840LO</b>	4000K	400	5.0	79.9
<b>840</b>	4000K	600	7.7	78.4
<b>840HO</b>	4000K	850	11.2	76.0
<b>840VHO</b>	4000K	1250	17.3	72.4

<sup>1</sup>LPW and watts/ft based off 48" fixture size.

## Length

- All individual units cannot be joined, end caps are factory installed and cannot be removed
- Add 3/8" for each end cap or 3/4" to the overall length of the row
- Aperture sizes vary, 4' fixtures have a single 45-7/16" long aperture, 6' fixtures have two 33-11/16" long apertures, and 8' fixtures have two 45-7/16" long apertures

4	6	8	-
Individual Fixture	Individual Fixture	Individual Fixture	Continuous Run
48" (1,219mm)	72" (1,829mm)	96" (2,438mm)	Continuous rows available in 2' increments, starting at 4'
Specify to the 2', starting at 4' >>>			

## Mounting

- Specify cable length in ordering code (AC48G1)
- Standard adjustable cable. Specify 48", 120", 240" or 350"
- Adjustable aircraft cable mounts on 4'-0" (1,219mm), 6' (1,829mm) or 8'-0" (3,438mm) center
- End caps and standard white power cord attached at factory
- Aircraft Cable supplied with 5" (127mm) power and 2" (51mm) non-power canopies
- Canopies match fixture finish, power cords are white, grey, or black depending on fixture finish. See Finish section for additional details
- Approved for dry/damp location unless otherwise noted
- Refer to installation instructions during installation at the job site
- Maximum fixture weight is 17 lbs. per 4' fixture

<b>AC_G1</b>	Adjustable AC to 1" (15/16") T-Bar
<b>AC_G9</b>	Adjustable AC to 9/16" T-Bar
<b>AC_GS</b>	Adjustable AC to Screw Slot T-Bar
<b>AC_JB</b>	Adjustable AC to Junction Box
<b>AC_ST</b>	Adjustable AC to Structure
<b>AC5_G</b>	5" (127mm) Non-Power Canopy
<b>AC5_JB</b>	5" (127mm) Non-Power Canopy
<b>SQ_G</b>	5" (127mm) Square Canopy
<b>SQ_JB</b>	5" (127mm) Square Canopy
<b>WA</b>	Wall Mount

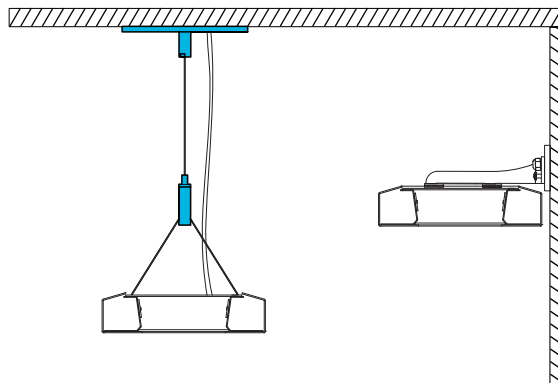

Specifications and dimensions subject to change without notice. Specification sheets that appear on pinnacle-ltg.com are the most recent version and supersede all other previously printed or electronic versions.

Designed in Denver, CO • USA | pinnacle-ltg.com | O: 303-322-5570 F: 303-322-5568

L8DI\_LED\_SPEC\_JUNE2021



## Voltage

- Some LINERO configurations will not accommodate all voltage options; consult with factory

<b>U</b>	Universal
<b>1</b>	120 volt
<b>2</b>	277 volt
<b>3</b>	347 volt

## Driver

- Standard Driver Option = PL2
- Driver Lifetime: 50,000 hours at 25°C ambient operating conditions
- For more driver options see Pinnacle Resource Guide
- Some LINERO configurations will not accommodate all driver options; consult with factory

<b>PL2</b>	Advance Xitanium 1%, 0-10v
<b>OL4</b>	Osram Optotronic 347v, 1%, 0-10v (requires 347v)
<b>OL5</b>	Osram Optotronic 1%, 0-10v, AUX
<b>OD1</b>	Osram Optotronic 1%, DEXAL
<b>EE1</b>	eldoLED ECOdrive 1%, 0-10v Logarithmic
<b>EE6</b>	eldoLED ECOdrive 1%, for nLight Air Wireless
<b>ES1</b>	eldoLED SOLOdrive 0%, DALI Logarithmic
<b>ES6</b>	eldoLED SOLOdrive 0%, for nLight Air Wireless
<b>LH1</b>	Lutron Hi-lume Soft-on, Fade-to-black 1%, EcoSystem, LDE1
<b>L51</b>	Lutron 5-Series 5%, EcoSystem, LDE5
<b>PR1</b>	Advance Xitanium SR, 5%
<b>OL2</b>	Osram Optotronic 1%, 0-10v
<b>ND</b>	Non-Dimming

## How to specify Circuiting, Battery and Emergency

- 1**
- Select fixture circuiting from options below
  - Some LINERO configurations will not accommodate all circuiting options, consult with factory

### Circuiting

<b>1</b>	Single Circuit
<b>M</b>	Multi Circuit
<b>E</b>	Emergency Circuit only
<b>N</b>	Night Light Circuit only

- 2** + **3**
- Battery and emergency section options are available in addition to fixture circuit
  - Select battery and emergency section options below; factory shop drawing required
  - Some LINERO configurations will not accommodate all circuiting options, consult with factory

### Battery and/or Emergency If Required

- 0** No battery or specific emergency section required

### Battery

- Select battery section type if required, indicate total QTY. *Example 2PL*
- 90 minute battery runtime; test button is integral to fixture
- For more battery options available, see Pinnacle Resource Guide

<b>0</b>	No battery
<b>_ILL</b>	Iota 10w Integral (self testing)
<b>_PLL</b>	Bodine 10w Integral Lithium (self testing)

### Emergency

- Select emergency section type if required, indicate total QTY. *Example 1E*
- Combine battery and emergency section ordering codes if both options are selected

<b>_E</b>	Emergency circuit section
<b>_N</b>	Night Light circuit section
<b>_L</b>	Life Safety circuit section NO THROUGH WIRE
<b>_G</b>	Bodine GTD, Generator Transfer Device section

#### Battery OR Emergency Ordering Examples

- Single circuit, 10w Integral Battery      Ordering Code: 1-1PL
- Emergency only, 10w Integral Battery      Ordering Code: E-1PL
- Single circuit, GTD required                  Ordering Code: 1-1G

#### For Approximate Battery Lumen Output

- Multiply battery wattage X fixture LPW shown on Lumen Table
- 92.3 (LPW) x 10 (watts) = 923 battery lumen output

#### Combination Section Ordering Examples

- Single circuit, (1) 10w battery, (1) emergency section  
Ordering Code: 1-1PL1E
- Multi circuit, (2) 10w battery, (2) emergency sections  
Ordering Code: M-2PL2E
- Single circuit, (1) night light section  
Ordering Code: 1-1N



## Finish

- Standard powder-coat textured white, metallic silver, textured black, graphite or bronze painted finish; consult factory for chip of standard paint finishes
- Selecting a fixture finish other than white may impact lumen output; consult factory for more information

<b>W</b>	White <i>(white cord/white canopy)</i>
<b>S</b>	Metallic Silver <i>(grey cord/silver canopy)</i>
<b>BL</b>	Textured Black <i>(black cord/black canopy)</i>
<b>BR</b>	Bronze <i>(white cord/bronze canopy)</i>
<b>GR</b>	Graphite <i>(white cord/graphite canopy)</i>
<b>CC</b>	Custom Color <i>(white cord/color match canopy)</i>

## Fixture Options

- Additional options to enhance the fixture and finish of the product

**QS** Quick Ship

## Quick Ship

Distribution	CRI, CCT & Output	Mounting	Voltage	Driver	Circuiting	Battery	Finish	
<b>10-Day</b>								
<b>40</b>	40% Direct	80 CRI, All color temperatures, all lumen packages including custom See pg 2-3	<b>AC__GX</b> Grid	<b>U</b> Universal	<b>PL2</b> Advance Xitanium	<b>1</b> Single Circuit <b>E</b> Emergency <b>N</b> Night Light	<b>1PL</b> Bodine 10w Integral <i>(low profile)</i>	<b>W</b> White
<b>70</b>	70% Direct		<b>AC__JB</b> Junction	<i>(120 thru 277)</i>	<b>LH1</b> Lutron LDE1			
<b>100</b>	100% Direct		<b>AC__ST</b> Box Structure	<b>1</b> 120 V <b>2</b> 277V	<b>OL2</b> Osram 0-10v, 1% <b>ND</b> Non-Dimming			

All lengths and continuous rows up to 1,000 ft OR 150 individual fixtures. Consult factory for larger projects.

## Controls

- Pinnacle Lighting offers easy to specify network control solutions that connect to an intelligent centralized system to maximize lighting energy efficiencies or integral sensors for individual fixture control
- Pinnacle Lighting fixtures ship technology ready; commissioning by others
- Controls can only be used with Single Circuit (1) or Emergency Circuit (E)
- Contact factory for any non-standard configurations for layout, placement, or EM options
- One drop/sensor per run typical, contact factory for more information

	Solution	Components	Network/Sensor	Connection	Required Drivers	Limitations
<b>DLMFC</b>	Legrand Wattstopper DLM	LMFC-011	Digital Lighting Management (DLM)	Wired, one RJ45 ports	Any 0-10v	Not available with Battery
<b>EASYS</b>	Philips EasySense	SNS-200	Daylight/PIR Occupancy	Wireless to switches	PR1	Not available with 347 volt
<b>SNSLM</b>	Osram Sensilum	EN-CLM-PIR-DD-ZB	Encelium, Daylight/PIR Occupancy	Wireless	OD1, OL5	Not available with 347 volt
<b>WLWX</b>	Eaton WaveLinx	SWPD1, MSP3IVMVC1	WaveLinx WCL, Daylight	Wireless	Any 0-10v	Not available with 347 volt
<b>VDO</b>	Lutron Vive Sensor	DFCSJ-OEM-OCC	Vive, Daylight/PIR Occupancy	Wireless	OD1, PR1	Not available with 347 volt
<b>VRF</b>	Lutron Vive Connected	DFCSJ-OEM-RF	Vive	Wireless	OD1, PR1	Not available with 347 volt
<b>ENLI</b>	Enlighted IOT	SU-5E-IOT, CU-4E	Enlighted, Daylight/PIR Occupancy	Wireless	Any 0-10v	Not available with 347 volt
<b>ENLC</b>	Enlighted Connected Lighting	SU-5E-CL, CU-4E	Enlighted, Daylight/PIR Occupancy	Wireless	Any 0-10v	Not available with 347 volt

Specifications and dimensions subject to change without notice. Specification sheets that appear on pinnacle-ltg.com are the most recent version and supersede all other previously printed or electronic versions.

Designed in Denver, CO • USA | pinnacle-ltg.com | O: 303-322-5570 F: 303-322-5568

L8DI\_LED\_SPEC\_JUNE2021



**Photometrics**

**Satine Lens 40% Direct**

Test #	ITL90501-GONIOPHOTOMETRY
Catalog #	L8DI-A-40-835VHO-4
Lumens	4917
Watts	31.7
Efficacy	155.1104101

**Satine Lens 70% Direct**

Test #	ITL90508-GONIOPHOTOMETRY
Catalog #	L8DI-A-70-840VHO-4
Lumens	5009
Watts	41.9
Efficacy	119.5

**Satine Lens 100% Direct**

Test #	ITL90514-GONIOPHOTOMETRY
Catalog #	L8D-A-100-840VHO-4
Lumens	4971
Watts	39.5
Efficacy	125.8

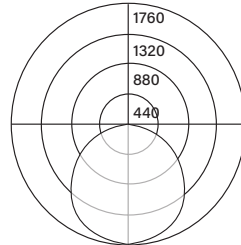
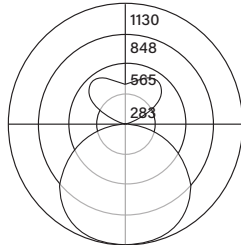
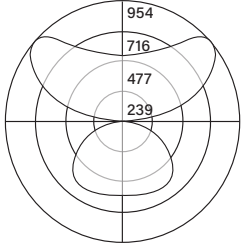

**Candela Distribution**

Vert Angle	Horizontal Angle				
	0	22.5	45	67.5	90
0	637	637	637	637	637
5	635	636	637	639	639
15	625	625	639	650	651
25	595	599	627	651	658
35	542	552	590	621	632
45	466	477	516	548	558
55	367	377	408	434	443
65	253	260	279	296	303
75	132	135	144	152	157
85	30	31	32	33	35
90	0	0	0	0	0
95	55	62	92	114	111
100	113	129	213	268	263
105	164	196	335	416	418
115	255	309	519	661	673
125	321	389	613	829	862
135	368	440	618	880	954
145	408	473	589	747	832
155	454	496	568	631	656
165	506	519	550	573	583
175	540	542	544	547	549
180	545	545	545	545	545

**Candela Distribution**

Vert Angle	Horizontal Angle				
	0	22.5	45	67.5	90
0	1129	1129	1129	1129	1129
5	1125	1125	1126	1127	1127
15	1094	1092	1106	1116	1116
25	1023	1022	1053	1074	1078
35	912	918	957	986	996
45	767	778	817	847	858
55	597	606	637	663	671
65	407	413	433	449	457
75	212	215	223	230	233
85	48	48	49	51	50
90	0	0	0	0	0
95	13	17	19	16	13
100	32	37	40	39	34
105	63	69	71	71	69
115	166	177	187	193	201
125	267	304	352	384	394
135	330	383	456	504	520
145	363	412	495	543	559
155	376	407	473	519	534
165	374	386	419	447	458
175	367	368	372	376	378
180	366	366	366	366	366

**Candela Distribution**

Vert Angle	Horizontal Angle				
	0	22.5	45	67.5	90
0	1760	1760	1760	1760	1760
5	1752	1752	1751	1753	1754
15	1690	1681	1697	1706	1703
25	1555	1548	1579	1597	1600
35	1366	1363	1401	1426	1435
45	1130	1136	1172	1197	1206
55	871	873	903	925	934
65	590	593	610	624	632
75	305	306	314	320	324
85	68	69	69	71	73
90	0	0	0	0	0

**Luminance Data (cd/sq.m)**

Angle In Degrees	Average 0-Deg	Average 45-Deg	Average 90-Deg
45	12833	13310	13696
55	12194	12642	13076
65	11210	11590	12008
75	9463	9742	10052
85	6265	6357	6726

**Luminance Data (cd/sq.m)**

Angle In Degrees	Average 0-Deg	Average 45-Deg	Average 90-Deg
45	5249	5812	6285
55	5096	5665	6151
65	4768	5258	5710
75	4062	4431	4831
85	2741	2924	3198

**Luminance Data (cd/sq.m)**

Angle In Degrees	Average 0-Deg	Average 45-Deg	Average 90-Deg
45	8639	9202	9664
55	8290	8845	9317
65	7670	8160	8612
75	6524	6862	7170
85	4386	4478	4569

Photometry based on ITL report ITL93486. For all available IES files, please visit our website at [pinnacle-ltg.com](http://pinnacle-ltg.com). Photometry testing in accordance to IESNA-LM-79-08 at an NVLAP accredited testing laboratory. Testing conducted at 25°C ambient conditions

Specifications and dimensions subject to change without notice. Specification sheets that appear on [pinnacle-ltg.com](http://pinnacle-ltg.com) are the most recent version and supersede all other previously printed or electronic versions.





## Approvals & Certifications

**Construction:** One piece die-formed 18 gauge steel housing in a 6-7/8" (174mm) by 1-11/16" (42mm) profile with a 1-3/8" (34mm) side profile. Standard 4'-0" (1,219mm), 6'-0" (1,828mm) and 8'-0" (3,438mm) fixtures can be joined to create continuous runs. Standard high reflectance die-formed white painted aluminum.

**Shielding:** Direct: white satine lens with matte finish. Indirect: 40/60 distribution uses a batwing diffuser, 70/30 distribution uses a perforated reflector and clear dust guard, 100 direct distribution uses a steel top cover. 4' fixtures have a single 45-7/16" long aperture, 6' fixtures have two 33-11/16" long apertures, and 8' fixtures have two 45-7/16" long apertures.

**Mounting:** Adjustable aircraft cable, or wall mounts available. Air Craft Cable mounts on 4'-0" (1,219mm), 6'-0" (1,828mm) and 8'-0" (3,438mm) centers. Refer to installation instructions for appropriate ceiling detail. Maximum fixture weight is 17 lbs. per 4' fixture.

**LED:** 25°C test environment. Lumen output/wattage has a margin of +/- 5%. All luminaire configurations tested in accordance with IES LM-79. Diodes tested in accordance with IES LM-80. Lifetime calculated using IES TM-21. Minimum lifetime greater than 60,000 hours. Lifetime Projection for 40%, 70% and 100%: L70 lifetime - 130,000 hours and L90 lifetime - 39,000 hours. MacAdam 3-Step Ellipses. For all available IES files, please visit our website at pinnacle-ltg.com.

**BIOS LED:** Spectrum focused lighting for circadian stimulus. EML or M/P ratio: .8 for 3500K, .9 for 4000K. COI >3.0. Not all lumen packages available. Two lumen packages available. Standard, and High (HO). Custom outputs are available. Specify custom lumens or watts between standard offering listed on CRI, CCT & Output page.

**CRI, CCT & Lumen Output:** Two lumen packages available. Standard and High (HO). Custom outputs are available. Specify custom lumens or watts between standard offering listed on CRI, CCT & Output page. 80 CRI is available for 3000K, 3500K, and 4000K. 90 CRI is available for 2700K, 3000K, 3500K, and 4000K. 80 CRI = R9≥19 and 90 CRI = R9≥61. Fixture performance and photometric data based on 8' configuration for worst case input voltage. Published lumen or wattage data based on OL1 configuration.

**Voltage:** Universal (U), 120 volt (1), 277 volt (2) and 347 volt (3) options available. Must specify OL4 in Driver section when 347 volt (3) is selected. Some LINERO configurations will not accommodate all voltage options; consult with factory.

**Driver:** Standard Driver Option is Advance Xitanium 0-10V, 1% = PL2. Electronic driver, Power factor is >0.9 with a THD <20%. Driver Lifetime: 50,000 hours at 25°C ambient operating conditions. Ambient operating range for 40%, 70% and 100%: -23F/-30C to 125F/52C For more driver options, see Pinnacle Resource Guide. Some LINERO configurations will not accommodate all driver options.

**Circuiting:** Select from single circuit (1), Multi circuit (M), Emergency circuit (E), Night Light circuit (N) or Life Safety (L). For emergency circuiting situations that require no through wire or circuit separation, Life Safety Circuit should be selected. This will provide a separate power feed and only the Life Safety Circuit in that section. Some LINERO configurations will not accommodate all circuiting options; consult with factory.

**Battery & Emergency:** Select battery or emergency options if required. If battery or emergency option is not required, enter 0. Battery duration is 90 minutes as standard. Test button is integral to fixture. For more Battery options, see Pinnacle Resource Guide.

**Finish:** Standard powder-coat textured white, metallic silver, textured black, graphite or bronze painted finish, consult factory for chip of standard paint finishes. Canopies painted white unless specified differently in the options section of the part number. Contact factory for additional custom color and finish options.

**Controls:** DLM utilizes wired network connections for digital control through switching and dimming with 0-10v LED drivers. nLight Air rIO module provides wireless control using eldoLED LED drivers. nLight Air rES7 sensor provides wireless control, daylight harvesting and occupancy detection with PIR or PDT using eldoLED LED drivers. EasySense sensor provides daylight harvesting and PIR occupancy detection using the SR driver; the Philips app provides advanced configurations. ENCELIUM SensiLUM sensor provides wireless control, daylight harvesting and PIR occupancy; driver data is available when using the DEXAL LED driver. WaveLinX Connected Lighting sensor provides wireless control and daylight harvesting using 0-10V LED drivers. Lutron Vive sensor provides wireless control, daylight harvesting and PIR occupancy detection using DEXAL or SR LED drivers. Lutron Vive module provides wireless control using DEXAL or SR LED drivers. Enlighted Smart Sensor provides multi-functionality including daylight harvesting and PIR occupancy; for IOT platform using 0-10v LED drivers. Enlighted Smart Sensor provides multi-functionality including daylight harvesting and PIR occupancy; for Connected platform using 0-10v LED drivers.

**Labels:** UL and cUL Listed. Approved for dry/damp location unless otherwise noted.

**Fixture Weight:** Maximum fixture weight is 17 lbs (per 4' fixture).

**Buy American Act Compliant**

**Warranty:** LINERO LED offered with a 5-year limited warranty. Covers LED, driver and fixture.