

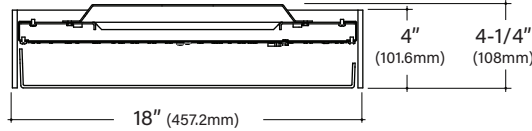

# FINA F18D

## 18" Direct Suspended Architectural Round



### Key Features

- Aluminum housing is rolled and welded for seamless finish with 1/4" trim
- Aluminum top cover conceals all electrical components. Highly reflective die-formed white painted steel reflector
- FINA offered with a 5-year limited warranty. Covers LED, driver and fixture
- ETL Listed conforming to UL1598 in US and CSA 250 in Canada
- Maximum fixture weight is 20 lbs
- Room-side maintenance for LED system
- Buy American Act compliant



Example Part #: F18D-A-830HO-AC348JB-U-PL2-1-0-W

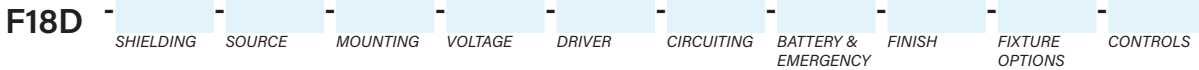

SHIELDING	SOURCE <sup>1</sup>	MOUNTING <sup>2</sup>	VOLTAGE
<p>---</p> <p><b>A</b> - Flush Satine Lens <b>AR</b> - Regress Satine Lens <b>AL</b> - Drop Satine Lens <i>Shielding pg. 2</i></p>	<p>---</p> <p><b>_27_</b> - 2700K <b>_30_</b> - 3000K <b>_35_</b> - 3500K <b>_40_</b> - 4000K <b>CL</b> - Custom Lumens <b>CW</b> - Custom Watts <i>Source pg. 2</i></p>	<p>---</p> <p><b>AC3</b> - 3 AC to JB or ST <b>AH4</b> - 4 AC w/hub to JB or ST <b>PP</b> - Pendant Pipe to JB or ST <b>PS</b> - Pendant Swivel to JB or ST <b>S</b> - Surface Mount <b>WA</b> - Wall Mount <i>Mounting pg. 3</i></p>	<p>---</p> <p><b>U</b> - Universal (120 thru 277V) <b>1</b> - 120V <b>2</b> - 277V <b>3</b> - 347V <i>Voltage pg. 3</i></p>
DRIVER	CIRCUITING	BATTERY & EMERGENCY	FINISH
<p>---</p> <p><b>PL2</b> - Advance Xitanium (1%, 0-10v) <b>EE1</b> - eldoLED ECOdrive (1%, 0-10v) <b>ES1</b> - eldoLED SOLOdrive (0%, 0-10v) <b>LH1</b> - Lutron Hi-lume (1%, EcoSystem) <b>L51</b> - Lutron 5-Series (5%, EcoSystem) <b>OL2</b> - Osram (1%, 0-10v) <b>OL4</b> - Osram 347V (1%, 0-10v) <b>ND</b> - Non-Dimming <i>Driver pg. 3</i></p>	<p>---</p> <p><b>1</b> - Single Circuit <b>E</b> - Emergency (<i>entire fixture</i>) <b>N</b> - Night Light (<i>entire fixture</i>) <i>Circuiting pg. 3</i></p>	<p>---</p> <p><b>0</b> - None <b>1PB</b> - Bodine 10W <i>Battery and Emergency pg. 4</i></p>	<p>---</p> <p><b>W</b> - White <b>S</b> - Metallic Silver <b>BL</b> - Textured Black <b>BR</b> - Bronze <b>GR</b> - Graphite <b>CC</b> - Custom Color <i>Finish pg. 4</i></p>
FIXTURE OPTIONS	CONTROLS <sup>3</sup>		
<p>---</p> <p><b>AM</b> - Antimicrobial Paint <b>GMF</b> - Slow Blow Fusing <i>Fixture Options pg. 4</i></p>	<p>---</p> <p><b>DLMFC</b> - Wattstopper DLM (<i>wired</i>) <b>ENLI</b> - Enlighted (<i>wireless</i>) <b>ENLC</b> - Enlighted (<i>wireless</i>) <i>Controls pg. 4</i></p>		

<sup>1</sup>When specifying SOURCE the first \_ is for specifying either **8** - 80CRI, **9** - 90CRI. The ending \_ \_ are for specifying output, example **HO** - High Output. <sup>2</sup>Example: AC348JB. AC3 = 3 Aircraft Cables, 48 = 48" long cables, JB = connects to junction box. Standard AC cable lengths are 48" and 120", field adjustable. Standard pendant lengths are 12", 18", or 24". <sup>3</sup>Controls can only be used with Single Circuit (1) or Emergency Circuit (E), cannot be used with any battery options. See Controls chart on page 4 for driver options and more information.



Specifications and dimensions subject to change without notice. Specification sheets that appear on pinnacle-ltg.com are the most recent version and supersede all other previously printed or electronic versions.



## Shielding

- White virgin acrylic lens with matte finish, removable for LED access
- Lens available in 3 positions

### Ordering Code

<b>A</b>	<b>AL</b>	<b>AR</b>
Flush Satine Lens	Drop Satine Lens	Regress Satine Lens
		

## Source: White LED

- Specify either 80 or 90 CRI
- Longer lead-time may apply for 90 CRI. Consult factory
- 80 CRI = R9≥19 and 90 CRI = R9≥61

## Custom Output- Lumens OR Wattage

<b>CL</b> _____	Specify CRI, CCT and desired lumens (i.e. CL8352000)	<i>Specify lumens between standard offering listed below. Lumens are specified per color temp</i>
<b>CW</b> _____	Specify CRI, CCT and desired wattage (i.e. CW94020)	<i>Specify watts between standard offering listed below</i>

### 80 CRI

	Color	Shielding		
		<b>A, AL, AR</b> Satine Lens		
		Lumens	Watts	LPW
<b>830LO</b>	3000K	1262	12.1	104
<b>830MO</b>	3000K	2169	20.2	107
<b>830HO</b>	3000K	3039	28.2	108
<b>835LO</b>	3500K	1357	12.2	111
<b>835MO</b>	3500K	2335	20.4	115
<b>835HO</b>	3500K	3274	28.5	115
<b>840LO</b>	4000K	1355	12.2	111
<b>840MO</b>	4000K	2329	20.3	115
<b>840HO</b>	4000K	3262	28.4	115

### 90 CRI

<b>927LO</b>	2700K	1063	12.7	84
<b>927MO</b>	2700K	1802	21.3	84
<b>927HO</b>	2700K	2492	30.3	82
<b>930LO</b>	3000K	1106	12.5	88
<b>930MO</b>	3000K	1876	21.1	89
<b>930HO</b>	3000K	2594	29.8	87
<b>935LO</b>	3500K	1106	12.5	88
<b>935MO</b>	3500K	1876	21.1	89
<b>935HO</b>	3500K	2594	29.8	87
<b>940LO</b>	4000K	1160	12.6	92
<b>940MO</b>	4000K	1963	21.2	92
<b>940HO</b>	4000K	2708	30.1	90



## Mounting

- Aircraft cables and pendants mount directly to a standard junction box or structure
- Canopies and pendants match fixture finish, power cords are white, grey, or black depending on fixture finish. See Finish section for additional details.
- Must specify overall pendant length of 12", 18" or 24"
- Must specify cable length, either 48" or 120" standard, field adjustable
- Tie off fixture to structure with retention wires
- Maximum fixture weight is 20 lbs

<b>AC3__JB</b> 3 AC cables to fixture to J-Box	<b>AH4__JB</b> 4 AC cables with hub to fixture to J-Box	<b>PP__JB</b> Pendant Pipe to J-Box	<b>S</b> Surface Mount Ceiling
<b>AC3__ST</b> 3 AC cables to fixture to Structure	<b>AH4__ST</b> 4 AC cables with hub to fixture to Structure	<b>PS__JB</b> Pendant Swivel to J-Box	<b>WA</b> Surface Mount Wall
		<b>PP__ST</b> Pendant Pipe to Structure	
		<b>PS__ST</b> Pendant Swivel to Structure	

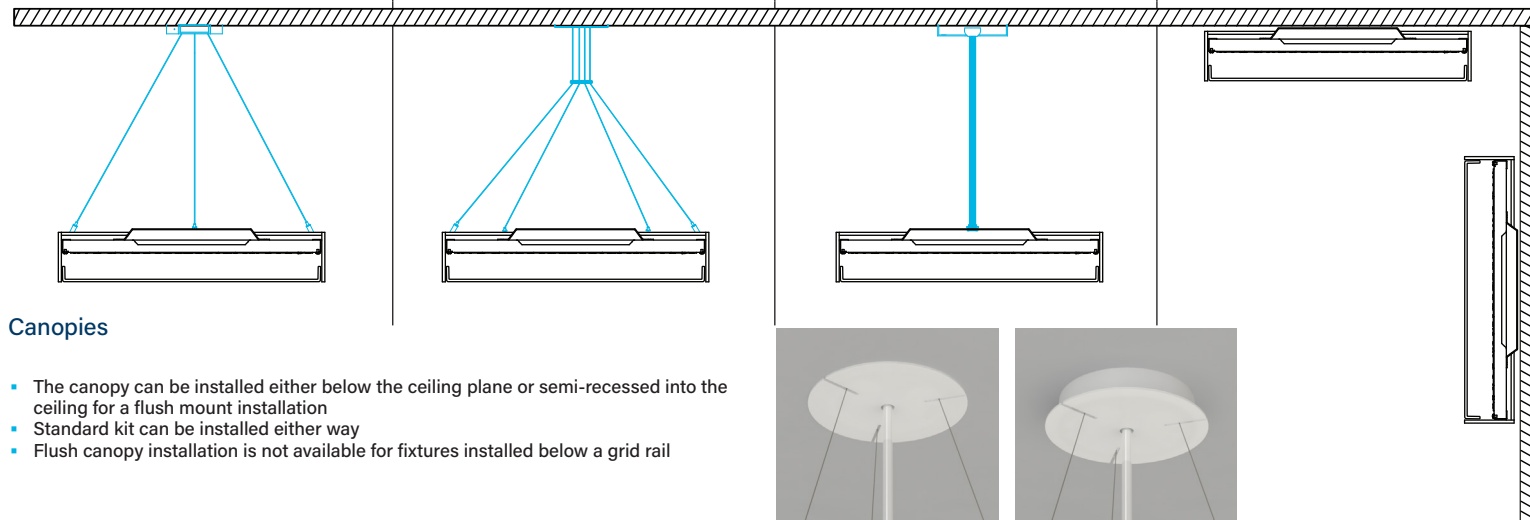

## Canopies

- The canopy can be installed either below the ceiling plane or semi-recessed into the ceiling for a flush mount installation
- Standard kit can be installed either way
- Flush canopy installation is not available for fixtures installed below a grid rail

## Voltage

- Some FINA configurations will not accommodate all voltage options; consult with factory

<b>U</b>	Universal
<b>1</b>	120 volt
<b>2</b>	277 volt
<b>3</b>	347 volt

## Driver

- Standard Driver Option = PL2
- Driver Lifetime: 50,000 hours at 25°C ambient operating conditions
- For more Driver options, see Pinnacle Resource Guide on download pages at pinnacle-ltg.com

- Some FINA configurations will not accommodate all driver options; consult with factory

<b>PL2</b>	Philips Advance Xitanium 1%, 0-10v
<b>EE1</b>	eldoLED ECOdrive 1%, 0-10v Logarithmic
<b>ES1</b>	eldoLED SOLOdrive 0%, 0-10v Logarithmic
<b>LH1</b>	Lutron Hi-lume Soft-on, Fade-to-black 1%, EcoSystem, LDE1
<b>L51</b>	Lutron 5-Series 5%, EcoSystem, LDE5
<b>OL2</b>	Osram Optotronic 1%, 0-10v, nominal 1% dimming range
<b>OL4</b>	Osram Optotronic 347v 1%, 0-10v, requires 347v option
<b>ND</b>	Non-Dimming

## Circuiting

- Select fixture circuiting from options below
- Some FINA configurations will not accommodate all circuiting options; consult with factory

<b>1</b>	Single Circuit
<b>E</b>	Emergency Circuit only
<b>N</b>	Night Light Circuit only



## Battery & Emergency

- Select battery or emergency options if required
- Battery duration is 90 minutes
- Test button is remote to fixture
- For more Battery options, see Pinnacle Resource Guide

<b>0</b>	No Battery
<b>1PB</b>	Bodine 10w

### For Approximate Battery Lumen Output

- Multiply battery wattage X fixture LPW shown on Lumen Table
- 10 (watts) x 92.3 (LPW) = 923 battery lumen output

### Battery & Emergency Ordering Examples

- Single circuit, 10w integral battery      Ordering Code: 1-1PB
- Emergency circuit only, 10w integral battery      Ordering Code: E-1PB

## Finish

- Standard powder-coat textured white, metallic silver, textured black, graphite or bronze painted finish; consult factory for chip of standard paint finishes
- Selecting a fixture finish other than white may impact lumen output; consult factory for more information

<b>W</b>	White ( <i>white cord/white canopy</i> )
<b>S</b>	Metallic Silver ( <i>grey cord/silver canopy</i> )
<b>BL</b>	Textured Black ( <i>black cord/black canopy</i> )
<b>BR</b>	Bronze ( <i>white cord/bronze canopy</i> )
<b>GR</b>	Graphite ( <i>white cord/graphite canopy</i> )
<b>CC</b>	Custom Color ( <i>white cord/color match canopy</i> )

## Fixture Options

- Additional options to enhance the fixture and finish of the product

<b>AM</b>	Antimicrobial Paint
<b>GMF</b>	Internal Slow Blow Fuse

## Controls

- Pinnacle Lighting offers easy to specify network control solutions that connect to an intelligent centralized system to maximize lighting energy efficiencies or integral sensors for individual fixture control
- Pinnacle Lighting fixtures ship technology ready; commissioning by others
- Controls can only be used with Single Circuit (1) or Emergency Circuit (E)
- Contact factory for any non-standard configurations for layout, placement, or EM options
- One sensor per housing typical, contact factory for more information

	Solution	Components	Network/Sensor	Connection	RQD Drivers	Limitation
<b>DLMFC</b>	Legrand Wattstopper DLM	LMFC-011	Digital Lighting Management (DLM)	Wired, two RJ45 ports	Any 0-10v	None
<b>ENLI</b>	Enlighted IOT	CU-4E	Enlighted, Remote	Enlighted Cable	Any 0-10v	Not available with 347 volt
<b>ENLC</b>	Enlighted Connected Lightign	CU-4E	Enlighted, Remote	Enlighted Cable	Any 0-10v	Not available with 347 volt



## Photometrics

### Satine Lens

Test # ITL92430  
 Catalog # F18D-AL-840HO  
 Lumens 3317 lm  
 Watts 28.2 W  
 Efficacy 118 LPW

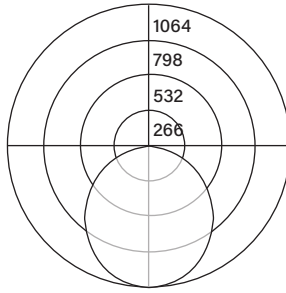

### Candela Distribution

Vert Angle	Horizontal Angle
0	0
0	1058
5	1064
10	1054
15	1031
20	998
25	958
30	910
35	855
40	794
45	727
50	655
55	579
60	498
65	413
70	326
75	240
80	160
85	93
90	44
95	38
100	33
105	28
110	23
115	18
120	14
125	10
130	7
135	4
140	2

### Luminance Data (cd/sq.m)

Angle In Degrees	Average 0-Deg	Average 45-Deg	Average 90-Deg
45	6547	6547	6547
55	6286	6286	6286
65	5868	5868	5868
75	5160	5160	5160
85	4381	4381	4381

For all available IES files, please visit our website at [pinnacle-ltg.com](http://pinnacle-ltg.com). Photometry testing in accordance to IESNA-LM-79-08 at an NVLAP accredited testing laboratory. Testing conducted at 25°C ambient conditions

## Approvals & Certifications

**Construction:** Extruded aluminum housing is rolled and welded for seamless finish with minimal trim detail. Aluminum top cover conceals all electrical components. Highly reflective die-formed white painted steel reflector. Wiring access on top of housing.

**Shielding:** Single piece diffuse lens creating a fully luminous housing. Available with standard satine lens.

**Mounting:** Aircraft cable, Pendant, Surface and Wall mount available. Aircraft Cable and pendant supplied with 5" (127mm) canopies. Refer to installation instructions for appropriate ceiling detail. Maximum fixture weight is 20 lbs.

**LED:** 25°C test environment. Lumen output/wattage has a margin of +/- 5%. All luminaire configurations tested in accordance with IES LM-79. Diodes tested in accordance with IES LM-80. Lifetime calculated using IES TM-21. Minimum lifetime greater than 60,000 hours. L70 = 146,500 hours and L90 = 45,000 hours. MacAdam 3-Step Ellipses. Not all products are Lighting Facts listed. For all available IES files, please visit our website at [pinnacle-ltg.com](http://pinnacle-ltg.com).

**CRI, CCT & Output:** Three lumen packages available. Low (LO), Mid (MO) and High (HO). Custom outputs are available. Specify custom lumens or watts between standard offering listed on CRI, CCT & Output page. 80 CRI is available for 3000K, 3500K, and 4000K. 90 CRI is available for 2700K, 3000K, 3500K, and 4000K. 80 CRI = R9≥19 and 90 CRI = R9≥61.

**Voltage:** Universal (U), 120 volt (1), 277 volt (2), 347 volt (3) options available. Must specify OL4 in Driver section when 347 volt (3) is selected. Some FINA configurations will not accommodate all voltage options; consult with factory.

**Driver:** Standard Driver Option is Advance 0-10V, 1% = PL2. Electronic driver, Power factor is >0.9 with a THD <20%. Driver Lifetime: 50,000 hours at 25°C ambient operating conditions. For more driver options, see Pinnacle Resource Guide on download pages at

[pinnacle-ltg.com](http://pinnacle-ltg.com). Some FINA configurations will not accommodate all driver options.

**Circuiting:** Select from Single circuit (1), Emergency circuit (E) or Night Light circuit (N). Some FINA configurations will not accommodate all circuiting options, consult with factory.

**Battery & Emergency:** Select battery or emergency options if required. If battery or emergency option is not required, enter 0. Battery duration is 90 minutes as standard. Test button is remote to fixture. For more Battery options, see Pinnacle Resource Guide on download pages at [pinnacle-ltg.com](http://pinnacle-ltg.com).

**Finish:** Standard powder-coat textured white, metallic silver, textured black, graphite, or bronze painted finish, consult factory for chip of standard paint finishes. Contact factory for additional custom color and finish options.

**Controls:** DLM utilizes wired network connections for digital control through switching and dimming with 0-10v LED drivers. Enlighted Smart Sensor provides multi-functionality including daylight harvesting and PIR occupancy; for IOT platform using 0-10v LED drivers. Enlighted Smart Sensor provides multi-functionality including daylight harvesting and PIR occupancy; for Connected platform using 0-10v LED drivers.

**Labels:** ETL Listed conforming to UL1598 in US and CSA 250 in Canada. LO, MO, and HO lumen packages are IC Rated, approved for dry/damp location unless otherwise noted.

**Fixture Weight:** 20 lbs maximum

**Buy American Act compliant**

**Warranty:** FINA LED offered with a 5-year limited warranty. Covers LED, driver and fixture.