

# CHUTE CDISR

Open Linear Direct/Indirect  
Suspended to Recessed

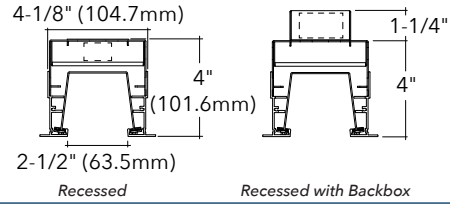

## Key Features

- Suspended to Recessed open aperture fixture
- Suspended: 6063-T6 Extruded aluminum housing
- Recessed: Extruded aluminum trim with formed cold rolled 18 gauge steel housing and back box
- 4" wide fixture with a 2 1/2" fully luminous aperture
- Small, integral driver option for quick, easy installation
- Light Protection Guard (LPG) covers LEDs for optimal performance
- 4 distinct decorative endcaps for tailored designs
- 5-year limited warranty covers LED, driver and fixture
- ETL listed conforming to UL 1598 in US and CSA 250 in Canada
- Buy American Act compliant



Example Part #: CDISR-N-830HO-26'-AC48G1/SF8-1-EL1-1-0-W-AT

## CDISR - BW

INDIRECT SHIELDING   DIRECT OUTPUT   INDIRECT OUTPUT   LENGTH   MOUNTING   VOLTAGE   DRIVER   CIRCUITING   BATTERY & EMERGENCY   FINISH   ENDCAPS   CONTROLS

INDIRECT SHIELDING	DIRECT CRI, CCT & OUTPUT <sup>1</sup>	INDIRECT CRI, CCT & OUTPUT <sup>1</sup>	LENGTH <sup>2</sup>
<b>BW</b> - Batwing	<b>_27_</b> - 2700K <b>_30_</b> - 3000K <b>_35_</b> - 3500K <b>_40_</b> - 4000K <b>CL</b> _____ - Custom Lumens <b>CW</b> _____ - Custom Watts <i>Direct CRI, CCT &amp; Output pg. 2</i>	<b>_27_</b> - 2700K <b>_30_</b> - 3000K <b>_35_</b> - 3500K <b>_40_</b> - 4000K <b>CL</b> _____ - Custom Lumens <b>CW</b> _____ - Custom Watts <i>Direct CRI, CCT &amp; Output pg. 2</i>	___ - Continuous Row <i>(Specify overall length of row, this will include both recessed and suspended sections. Recessed only specified in Mounting section)</i> Length pg. 3

MOUNTING <sup>3</sup>	VOLTAGE	DRIVER	CIRCUITING <sup>4</sup>
<b>Suspended Mounting</b> <b>AC_G</b> - AC to Grid <b>AC_JB</b> - AC to J Box <b>AC_ST</b> - AC to Structure <b>Recessed Mounting</b> <b>SF</b> - Spackle Flange <i>(Specify Recessed length, example 8' length is SF8)</i> Mounting pg. 3	<b>U</b> - Universal (120 thru 277V, remote) <b>1</b> - 120V <b>2</b> - 277V <b>3</b> - 347V (remote) <i>Voltage pg. 4</i>	<b>Integral Driver / 4" Recessed Housing</b> <b>EL1</b> - ERP Power (1%, 0-10v, 120v or 277v) <b>Remote Drivers / Recessed with Backbox</b> <b>PL2</b> - Advance Xitanium (1%, 0-10v) <b>OL2</b> - Osram (1%, 0-10v) <b>OL4</b> - Osram 347v (1%, 0-10v) <b>EE1</b> - eldoLED ECOdrive (1%, 0-10v) <b>ES1</b> - eldoLED SOLOdrive (0%, 0-10v) <b>LH1</b> - Lutron Hi-lume (1%, EcoSystem) <b>LS1</b> - Lutron 5-Series (5%, EcoSystem) <b>ND</b> - Non-Dimming <i>Driver pg. 4</i>	<b>1</b> - Single Circuit <b>2</b> - Dual Circuit <b>M</b> - Multi Circuit <b>E</b> - Emergency (entire fixture) <b>N</b> - Night Light (entire fixture) <i>Circuiting pg. 4</i>

BATTERY & EMERGENCY <sup>5</sup>	FINISH	SUSPENDED ENDCAP	FIXTURE OPTIONS	CONTROLS
<b>0</b> - None <b>_PRD</b> - Bodine 10W (remote) <b>_IRC</b> - Iota 10W (remote) <b>_E</b> - Emergency Section <b>_N</b> - Night Light Section <b>_L</b> - Life Safety Section <b>_G</b> - Bodine GTD <i>Battery &amp; Emergency pg. 4</i>	<b>W</b> - White <b>S</b> - Metallic Silver <b>BL</b> - Textured Black <b>BR</b> - Bronze <b>GR</b> - Graphite <b>CC</b> - Custom Color <i>Finish pg. 5</i>	<b>FE</b> - Flat Endcap <b>IB</b> - Inward Bevel Endcap <b>OB</b> - Outward Bevel Endcap <b>AT</b> - Angled Twist Endcap <i>Endcaps pg. 5</i>	<b>CP</b> - Chicago Plenum <i>Fixture Options pg. 5</i>	<i>Pinnacle is able to accommodate different control solutions from different manufacturers. Consult Factory for more information.</i>

<sup>1</sup>When specifying CRI, CCT & OUTPUT the first \_\_\_ is for specifying either **8** - 80CRI or **9** - 90CRI. The ending \_\_\_ are for specifying output, example **HO** - High Output. See output charts for more information. <sup>2</sup>Suspended section can be made in 2' increments, recessed section can be made in 1' increments. <sup>3</sup>When specify cable length standard AC is **48'**, **120'**, or **240'** When Specifying grid for AC\_\_G use one of the following: **G1**=15/16", **G9**=9/16" or **GS**=Screw Slot. Example: AC48G1. When specifying spackle flange section use the "\_\_\_" to enter the recessed length. Recessed sections can be specified in 1' increments, and will be a section from the total length specified in the length. Recessed non joined end will have closed endcap. <sup>4</sup>No through wire will be provided between suspended and recessed fixtures. <sup>5</sup>All Battery & Emergency options are REMOTE. Enter quantity for Battery and Emergency, Example 2P.

Specifications and dimensions subject to change without notice. Specification sheets that appear on pinnacle-ltg.com are the most recent version and supersede all other previously printed or electronic versions.



## CRI, CCT & Output

- 80 CRI = R9≥5, 90 CRI = R9≥61

### Custom Output - Lumens OR Wattage

<b>CL</b> _____	Specify CRI, CCT and desired lumens (i.e. CL835500)	<i>Specify lumens between standard offering listed below. Lumens are specified per color temp</i>
<b>CW</b> _____	Specify CRI, CCT and desired wattage (i.e. CW9407)	<i>Specify watts between standard offering listed below</i>

### Direct 80 CRI

	Color	Output <sup>1</sup>		
		Lumens/ft	LPW	Watts/ft
<b>830</b>	3000K	500	115	4.3
<b>830HO</b>	3000K	750	116	6.5
<b>830VHO</b>	3000K	1000	116	8.6
<b>835</b>	3500K	500	123	4.1
<b>835HO</b>	3500K	750	124	6.0
<b>835VHO</b>	3500K	1000	125	8.0
<b>840</b>	4000K	500	128	3.9
<b>840HO</b>	4000K	750	128	5.9
<b>840VHO</b>	4000K	1000	128	7.8

### Direct 90 CRI *(longer lead times may apply, consult factory)*

<b>927</b>	2700K	500	97	5.2
<b>927HO</b>	2700K	750	97	7.7
<b>927VHO</b>	2700K	1000	100	10.0
<b>930</b>	3000K	500	105	4.8
<b>930HO</b>	3000K	750	105	7.1
<b>930VHO</b>	3000K	1000	106	9.4
<b>935</b>	3500K	500	110	4.6
<b>935HO</b>	3500K	750	110	6.8
<b>935VHO</b>	3500K	1000	111	9.0
<b>940</b>	4000K	500	107	4.7
<b>940HO</b>	4000K	750	107	7.0
<b>940VHO</b>	4000K	1000	108	9.3

### Indirect 80 CRI

	Color	Lumens per foot	Shielding <sup>1</sup>	
			BW Batwing	Watts/ft
<b>830</b>	3000K	500	131	3.8
<b>830HO</b>	3000K	750	132	5.7
<b>830VHO</b>	3000K	1000	132	7.6
<b>835</b>	3500K	500	140	3.6
<b>835HO</b>	3500K	750	141	5.3
<b>835VHO</b>	3500K	1000	142	7.1
<b>840</b>	4000K	500	145	3.5
<b>840HO</b>	4000K	750	146	5.1
<b>840VHO</b>	4000K	1000	146	6.8

### Indirect 90 CRI *(longer lead times may apply, consult factory)*

<b>927</b>	2700K	500	110	4.5
<b>927HO</b>	2700K	750	110	6.8
<b>927VHO</b>	2700K	1000	111	9.0
<b>930</b>	3000K	500	119	4.2
<b>930HO</b>	3000K	750	119	6.3
<b>930VHO</b>	3000K	1000	120	8.3
<b>935</b>	3500K	500	124	4.0
<b>935HO</b>	3500K	750	125	6.0
<b>935VHO</b>	3500K	1000	125	8.0
<b>940</b>	4000K	500	121	4.1
<b>940HO</b>	4000K	750	121	6.2
<b>940VHO</b>	4000K	1000	122	8.2

<sup>1</sup>LPW and watts/ft based off 48" fixture size, see IES files for specific fixture length.



## Length

- Suspended lengths must be specified in 2' increments, Recessed lengths must be specified in 1' increments.
- Recessed length is to the foot. Example 8' = 96"
- For Standard Flat end cap adds 5/16" (7.6mm) to the overall length of the row.
- For Inward Bevel end cap adds 13/32" (10.1mm) to the overall length of the row.
- For Outward Bevel end cap adds 23/32" (18.4mm) to the overall length of the row.
- For Angled Twist end cap adds 1/2" (12.6mm) to the overall length of the row.
- See page 4 for endcap details.
- Consult factory for additional lengths.

### Continuous Run

Specify nominal overall row length. Suspended portion must be in 2' increments. Recessed portion must be in 1' increments.

### Specify Overall Length

Fixture lengths do not include endcap dimensions. See bullet points listed above for each endcap. Example: 2' fixture (24") + 1 Standard Flat Endcap (5/16") = 24 5/16" overall.

### Length Breakdown

- Specified Length: 16' - Mounting: AC48G1/SF8 = 16' overall, 8' Suspended & 8' Recessed

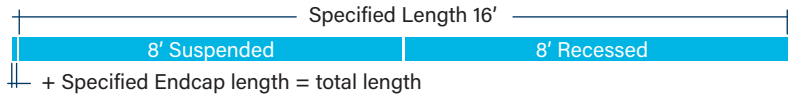

## Suspended Mounting

- Specify cable length in ordering code (AC48G1)
- Standard specifiable lengths are 48", 120", 240" and 350"
- End plates and power cord attached at factory
- Aircraft cable (AC) mounts on 4' (1219.2mm) and 8' (2438.4mm) centers
- Aircraft Cable supplied with 5" (127mm) power and 2" (50.8mm) non-power canopies
- Canopies are painted to match fixture finish, power cords are white, grey, or black depending on fixture finish. See Finish section for additional details
- Approved for dry/damp location unless otherwise noted
- Refer to installation instructions during installation at the job site
- Maximum fixture weight is 20 lbs for a standard 4' fixture
- Remote box will be included for all specifications that include batteries, GTD, or a driver OTHER THAN the EL1. See Installation Instructions for more specific information about mounting
- For integral driver version, access for wiring and drivers through the indirect side of the fixture only

AC_G1	Aircraft Cable 1" (15/16") T-Bar
AC_G9	Aircraft Cable 9/16" T-Bar
AC_GS	Aircraft Cable Screw Slot T-Bar
AC_JB	Aircraft Cable Junction Box
AC_ST	Aircraft Cable Structure
AC5_G	Aircraft Cable 5" (127mm) Non-Power Canopy
AC5_JB	Aircraft Cable 5" (127mm) Non-Power Canopy
SQ_G	Aircraft Cable 5" (127mm) Square Canopy
SQ_JB	Aircraft Cable 5" (127mm) Square Canopy

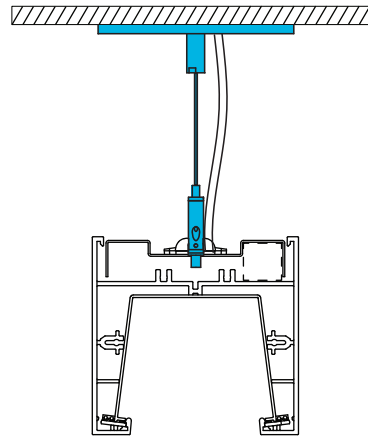

AC - Single, Adjustable AC Cable

## Recessed Mounting

- Continuous Units, specify, SF\_\_
- Use "\_\_" to specify recessed length in 1' increments
- Designed to install into inaccessible ceilings
- Approved for dry/damp location unless otherwise noted

### SF\_\_

Drywall, Flangeless Detail  
Flange to Flange:  
6" (152.4mm)

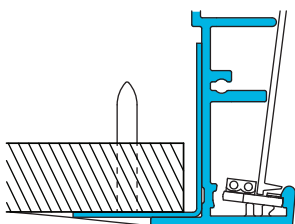



## Voltage

- Some CHUTE configurations will not accommodate all voltage options; consult with factory
- For EL1 driver, must specify 120v or 277v

<b>U</b>	Universal <i>(remote)</i>
<b>1</b>	120 volt
<b>2</b>	277 volt
<b>3</b>	347 volt <i>(remote)</i>

## Driver

- Standard Driver Option = EL1
- Driver Lifetime: 50,000 hours at 25°C ambient operating conditions
- For more driver options see Pinnacle Resource Guide
- Some CHUTE configurations will not accommodate all driver options; consult with factory
- On suspended fixtures, EL1 driver is integral to the fixture housing. Remote box necessary for all drivers OTHER THAN the EL1
- On recessed fixtures, EL1 driver is in a 4" housing. Deeper 5 1/4" necessary for all drivers OTHER THAN the EL1
- Osram and Lutron Drivers have a remote distance limitation of 10'
- eldoLED and Advance Drivers have an average remote distance limitation of 50'. Consult Factory for specific configurations

Standard Remote Box

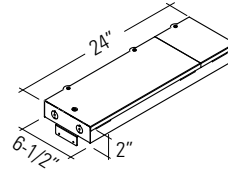

### Integral Driver/ 4" Recessed Housing

**EL1** ERP Power 1%, 0-10v, requires 120 or 277

### Remote Driver/ Recessed with Backbox

<b>OL2</b>	Osram Optotronic 1%, 0-10v, nominal 1% dimming range
<b>OL4</b>	Osram Optotronic 347v 1%, 0-10v, requires 347v option
<b>EE1</b>	eldoLED ECOdrive 1%, 0-10v Logarithmic
<b>EE2</b>	eldoLED ECOdrive 1%, 0-10v Linear
<b>ES1</b>	eldoLED SOLOdrive 0%, 0-10v Logarithmic
<b>ES2</b>	eldoLED SOLOdrive 0%, 0-10v Linear
<b>LH1</b>	Lutron Hi-lume Soft-on, Fade-to-black 1%, EcoSystem, LDE1
<b>L51</b>	Lutron 5-Series 5%, EcoSystem, LDE5
<b>PL2</b>	Advance Xitanium 1%, 0-10v
<b>PS1</b>	Advance Xitanium Step Dimming 50%/100%
<b>ND</b>	Non-Dimming

## How to specify Circuiting, Battery and Emergency

- 1**
- Select fixture circuiting from options below
  - Some CHUTE configurations will not accommodate all circuiting options, consult with factory

### Circuiting

<b>1</b>	Single Circuit
<b>2</b>	Dual Circuit
<b>M</b>	Multi Circuit
<b>E</b>	Emergency Circuit only
<b>N</b>	Night Light Circuit only

- 2** + **3**
- Battery and emergency section options are available in addition to fixture circuit
  - Select battery and emergency section options below; factory shop drawing required
  - Some CHUTE configurations will not accommodate all circuiting options, consult with factory

### Battery and/or Emergency *If Required*

**0** No battery or specific emergency section required



## Battery

- Battery is REMOTE or in RECESSED BACK BOX
- Select battery section type if required, indicate total QTY. *Example 2PL*
- 90 minute battery runtime; test button is remote to fixture and requires an additional drop
- Entire fixture housing is on battery for 2' and 4' lengths
- 4' of fixture is on battery for 6' or 8' housing lengths
- VHO and 90 CRI, HO not available with remote driver
- For more battery options available, see [Pinnacle Resource Guide](#)

### For Approximate Battery Lumen Output

- Multiply battery wattage X fixture LPW shown on Lumen Table
- 92.3 (LPW) x 10 (watts) = 923 battery lumen output

<b>0</b>	No battery
<b>_PRD</b>	Bodine 10w, remote with conduit
<b>_IRC</b>	lota 10w, remote with conduit

## Emergency

- GTD is REMOTE
- Select emergency type if required, indicate total QTY. *Example 1E*
- Emergency available in 4' increments
- Combine battery and emergency ordering codes if both options are selected

### Battery OR Emergency Ordering Examples

- Single circuit, 10w Integral Battery    Ordering Code: 1-1PLL
- Emergency only, 10w Integral Battery    Ordering Code: E-1PLL
- Single circuit, GTD required    Ordering Code: 1-1G

<b>_E</b>	Emergency circuit
<b>_N</b>	Night Light circuit
<b>_L</b>	Life Safety circuit section NO THROUGH WIRE
<b>_G</b>	Bodine GTD, Generator Transfer Device

### Combination Section Ordering Examples

- Single circuit, (1) 10w battery, (1) emergency    Ordering Code: 1-1PLL1E
- Multi circuit, (2) 10w battery, (2) emergency    Ordering Code: M-2PLL2E
- Single circuit, (1) night light    Ordering Code: 1-1N

## Finish

- Standard powder-coat textured white, metallic silver, textured black, graphite or bronze painted finish; consult factory for chip of standard paint finishes
- Selecting a fixture finish other than white may impact lumen output; consult factory for more information

<b>W</b>	White ( <i>white cord/white canopy</i> )
<b>S</b>	Metallic Silver ( <i>grey cord/silver canopy</i> )
<b>BL</b>	Textured Black ( <i>black cord/black canopy</i> )
<b>BR</b>	Bronze ( <i>white cord/bronze canopy</i> )
<b>GR</b>	Graphite ( <i>white cord/graphite canopy</i> )
<b>CC</b>	Custom Color ( <i>white cord/color match canopy</i> )

## Fixture Options

- Endcap MUST be specified.

<b>FE</b>	Flat Endcap
<b>IB</b>	Inward Bevel Endcap
<b>OB</b>	Outward Bevel Endcap
<b>AT</b>	Angled Twist Endcap

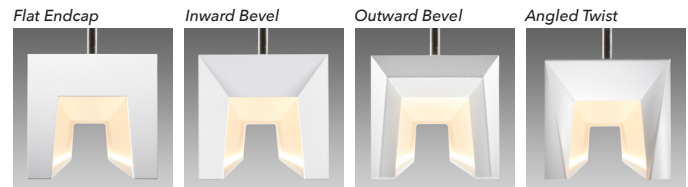

## Fixture Options

- Additional options to enhance the fixture and finish of the product

<b>CP</b>	Chicago Plenum, applies to recessed fixtures and all necessary remote boxes
-----------	---

## Controls

- Pinnacle is able to accommodate different control solutions from different manufacturers. Consult Factory for more information.



Photometrics

Open - Batwing

Test # ITL93069 & 93070  
 Catalog # CDI-BW-835VHO-835VHO-4  
 Lumens 8670 lm  
 Watts 66.3 W  
 Efficacy 130.8 LPW

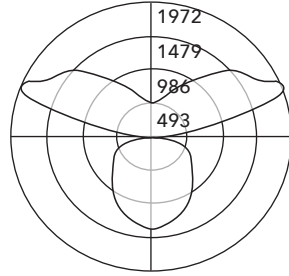

Candela Distribution

Vert Angle	Horizontal Angle				
	0	22.5	45	67.5	90
0	1411	1411	1411	1411	1411
5	1410	1394	1397	1393	1386
15	1369	1332	1311	1292	1280
25	1289	1229	1191	1157	1141
35	1169	1093	1037	986	964
45	1010	927	850	798	782
55	816	733	661	656	656
65	593	521	517	545	552
75	357	341	397	427	428
85	121	193	111	61	46
90	0	20	91	22	18
95	39	100	685	174	108
105	134	194	910	1467	1119
115	237	293	649	1695	1974
125	321	396	670	1400	1633
135	365	447	721	1212	1467
145	402	475	704	982	1116
155	456	503	646	792	855
165	504	521	584	641	664
175	530	524	535	541	543
180	527	527	527	527	527

Luminance Data (cd/sq.m)

Angle In Degrees	Average 0-Deg	Average 45-Deg	Average 90-Deg
45	17359	8760	7020
55	16923	7090	5971
65	16118	5971	5257
75	14725	5135	4415
85	11038	1690	535

Applications & Certificates

**Construction:** Suspended: 6063-T6 Extruded aluminum housing. Highly reflective coextruded acrylic reflector with LED protection guard. Recessed: Extruded aluminium rails and formed cold-rolled 18 gauge steel housing. Highly reflective coextruded acrylic reflector with LED protection guard.

**Mounting:** CHUTE Recessed is designed to install into inaccessible ceilings. Specify SF for continuous runs. Maximum recessed fixture weight is 15lbs per 4' fixture. CHUTE Suspended Aircraft cable mounting. Straight aircraft cable that mounts on 4'-0" (1219.2mm) and 8'-0" (2438.4mm) centers. Aircraft Cable supplied with 5" (127mm) power and 2" (50.8mm) non-power canopies. Refer to installation instructions for appropriate ceiling detail. Canopies are painted white unless otherwise specified. Maximum suspended fixture weight is 25 lbs. for a standard 4' fixture. Fixture can only be mounted perpendicular to bulk head.

**LED:** 25°C test environment. Lumen output/wattage has a margin of +/- 5%; 2' lengths may have a greater wattage deviation. All luminaire configurations tested in accordance with IES LM-79. Diodes tested in accordance with IES LM-80. Lifetime calculated using IES TM-21. Minimum lifetime greater than 60,000 hours. L70 = 146,500 hours and L90 = 45,000 hours. MacAdam 3-Step Ellipses. Not all products are Lighting Facts listed. For all available IES files, please visit our website at pinnacle-ltg.com.

**CRI, CCT & Output:** Three lumen packages available. Standard, High (HO), and Very High (VHO). Custom outputs are available. Specify custom lumens or watts between standard offering listed on CRI, CCT & Output page. 80 CRI is available for 3000K, 3500K, and 4000K. 90 CRI is available for 2700K, 3000K, 3500K, and 4000K. 80 CRI = R9≥5 and 90 CRI = R9≥61.

**Voltage:** Universal (U), 120 volt (1), 277 volt (2) and 347 volt (3) options available. Must specify OL4 in Driver section when 347 volt (3) is selected. Some CHUTE configurations will not accommodate all voltage options; consult with factory.

**Driver:** CHUTE Recessed: Standard INTEGRAL Driver Option is EL1. All other driver options will be in driver backbox. CHUTE Suspended: Standard INTEGRAL Driver Option is EL1. All other driver options will be in remote box. EL1 designed for use with 120v or 277v only. Electronic driver, Power factor is >0.9 with a THD <20%. Driver Lifetime: 50,000 hours at 25°C ambient operating conditions. Ambient operating range: -20°F/-30°C to 128°F/54°C. When ND is specified, a spec grade driver will be provided. For more driver options, see Pinnacle Resource Guide. Some CHUTE configurations will not accommodate all driver options.

Suspended Section - Remote Box Mounting Guide (Advance & eldoLED)

Distance limited by max input watts shown, Direct & Indirect should be calculated separately

Max Distance	142'	107'	71'	50'	37'
4' Housing	4.9w/ft	6.4w/ft	9.5w/ft	13w/ft	N/A
8' Housing	N/A	3.1w/ft	4.8w/ft	6.9w/ft	9w/ft

**Circuiting:** Select from single circuit (1), Multi circuit (M), Emergency circuit (E) or Night Light circuit (N). For emergency circuiting situations that require no through wire or circuit separation, Life Safety Circuit should be selected. This will provide a separate power feed and only the Life Safety Circuit in that section. Some CHUTE configurations will not accommodate all circuiting options, consult with factory.

**Battery & Emergency:** Select battery or emergency options if required. If battery or emergency option is not required, enter 0. Battery duration is 90 minutes as standard. Test button is remote to fixture. For more Battery options, see Pinnacle Resource Guide.

**Finish:** Standard powder-coat textured white, metallic silver, textured black, graphite or bronze painted finish; consult factory for chip of standard paint finishes. Canopies painted to match fixture specified fixture finish. Contact factory for additional custom color and finish options.

**Controls:** Pinnacle is able to accommodate different control solutions from different manufacturers. Consult Factory for more information.

**Labels:** ETL listed conforming to UL 1598 in US and CSA 250 in Canada. Approved for dry/damp location unless otherwise noted.

**Fixture Weight:** Maximum fixture weight is 25 lbs. for a standard 4' fixture.

Buy American Act Compliant

**Warranty:** CHUTE LED offered with a 5-year limited warranty. Covers LED, driver and fixture.