

T5 RECESSED LINEAR DIRECT / Staggered Lamp / Parabolic Louver

CONSTRUCTION Formed cold rolled steel housing. Highly reflective die-formed white painted steel reflector. Die-formed anodized snap-in aluminum semi-specular parabolic louver removable for lamp replacement.

ELECTRICAL Standard programmed start UL listed Class P, T5 electronic, Sound Rated A, thermally protected, high power factor ballasts less than 10% THD, Universal voltage (120/277) with 50/60Hz operation. Through wiring with quick connects standard. Standard single circuit. Integral battery packs with remote test switch are provided with 1B option. Each ballast provided with disconnects to meet luminaire disconnect code requirement.

MOUNTING Edge is designed to install into acoustical grid and inaccessible ceilings. Specify GXG, FLF, SFS, NFN for Individual, unjoinable units (individual units will fall on-grid). Specify GX, FL, SF, NF for continuous rows (Rows fall on-grid). Consult factory for detailed installation instructions.

FINISH Standard powder-coat textured white painted finish on exposed trim, consult factory for custom colors.

LABELS UL and cUL Listed, approved for dry/damp location unless otherwise noted.

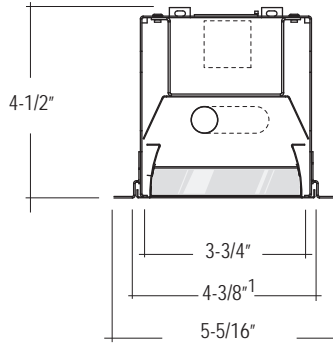

¹Rough-in width is 4-5/8" for inaccessible ceilings. Must mount through top of fixture. See installation instructions for further details. Specification Sheets should not be used for installation.

LUMINAIRE SPECIFICATION

Sample Catalog #: E4SP-1T5-24'-FL-120-1C-W

HOUSING	LAMPS	LENGTH	MOUNTING ¹	VOLTAGE	CIRCUITING	FINISH	OPTIONS
E4SP- Edge 4 Staggered Lamp recessed with Parabolic Louver	1T5- (1) T5 1T5HO- (1) T5HO	Individual Units ² 2- 2' Not available as individual 3- 3' Not available as individual 4- 4' Not available as individual 6- 6' 8- 8' Continuous Runs ³ xx'- Specify nominal overall row length in 1' increments		120- 120 V 277- 277 V 347- 347 V ⁵ UNV-UNV ⁵ (120/277)	1C- Single Circuit 1D- Single Circuit Dimming ⁶ 1B- Single Circuit with Battery Pack ^{6,10} 1E- Single Circuit with Emergency Circuit ⁶	W- Matte White CC- Custom Color	PM- Perimeter Mount ⁷ RC- Rotating Crossbar ⁸ CP- Chicago Plenum CL- Illuminated Connector ⁹ LO- Lens Overlay
INDIVIDUAL UNITS (CANNOT BE JOINED)²		CONTINUOUS RUNS (JOINABLE)³					
Acoustical Grid Ceiling		Inaccessible Ceiling					
G1G- 1" Ceiling Grid		FLF- Standard 1/2" Flange					
G9G- 9/16" Ceiling Grid		SFS- Spackle Flange					
GSG- Screw Slot Ceiling Grid		NFN- Flangeless ⁴					
		Acoustical Grid Ceiling					
		G1- 1" Ceiling Grid					
		G9- 9/16" Ceiling Grid					
		GS- Screw Slot Ceiling Grid					
		Inaccessible Ceiling					
		FL- Standard 1/2" Flange					
		SF- Spackle Flange					
		NF- Flangeless ⁴					

¹ See below for mounting detail. Consult factory for regular edged tiles.
² Individual units cannot be joined. All end trims are factory installed and cannot be removed in the field. Individual fixtures designed to fall on-grid.
³ Continuous runs are designed to fall on-grid with acoustical grid ceilings.
⁴ NFN and NFN to be utilized for metal pan / millwork ceiling.
⁵ 347 volt and UNV not available with MR16 and battery packs.

⁶ Some Edge configurations will not accommodate all electrical options. Consult factory.
⁷ Available for acoustical grid ceilings. Wall rail painted white unless otherwise specified.
⁸ 1/2" to 5/8" drywall thickness. Available for standard 1/2" flange (FL).
⁹ Add CL to all fixture types involved in the connector layout. See back page for additional information.
¹⁰ Integral battery packs with remote test switch are provided with 1B option.

Individual Luminaires¹

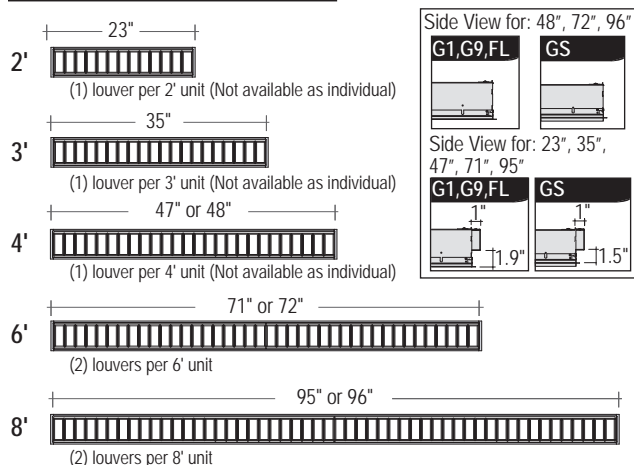

¹ Acoustical Grid Ceiling and Inaccessible Ceilings available as individual units or continuous rows. Individual units and rows are available for on-grid installation with acoustical ceilings.

Mounting Detail

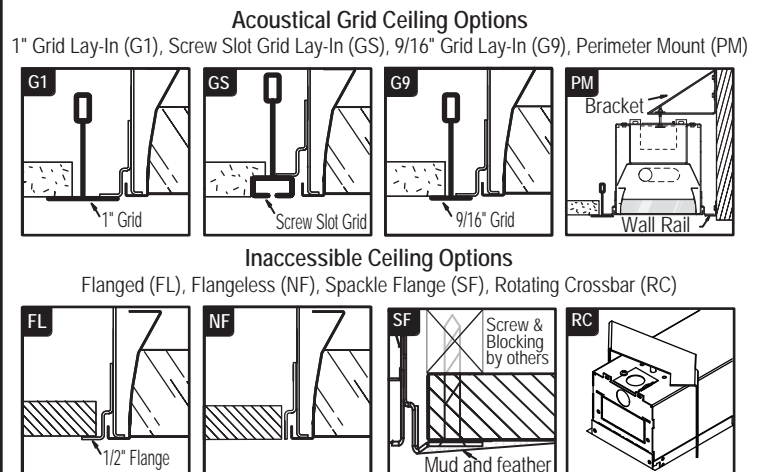

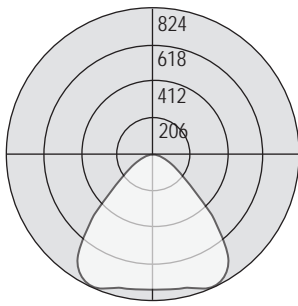

Test # 202621
Lamp: (1) 28 Watt T5
Total Luminaire Efficiency: 66.7%

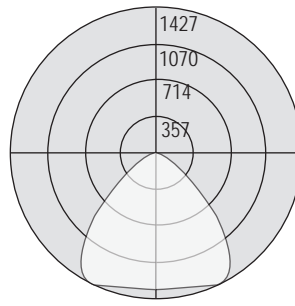

Test # 202622
Lamp: (1) 54 Watt T5HO
Total Luminaire Efficiency: 67.2%

FEATURES AND OPTIONS

• CIRCUITING

Single Circuit (1C) Layout

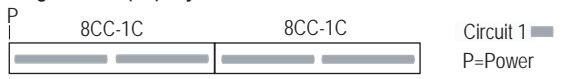

Single Circuit with Emergency Circuit (1E) Layout



• ILLUMINATED CONNECTOR

APPLICATION: The patent pending connector carries a low wattage PL lamp for seamless layouts while offering limitless system configurations. Recommended for gypsum board or inaccessible ceilings using the standard 1/2" flange mount (FL).

CONSTRUCTION: Formed cold rolled steel housing. The height is 10.25" and width is 4.40". T5 utilizes a 7 watt PL lamp and T5HO utilizes a 13 watt PL lamp. Connector cannot be dimmed. Factory submittal drawings required.

ORDERING INFORMATION: Specify Illuminated Connector (CL) in the options section of the part number. Sample Catalog #: E4SP-1T5-24-FL-120-1C-W-CL.

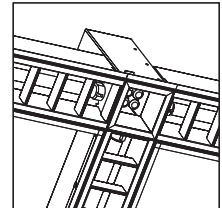

• STAGGERED LAMP ROW EXAMPLES

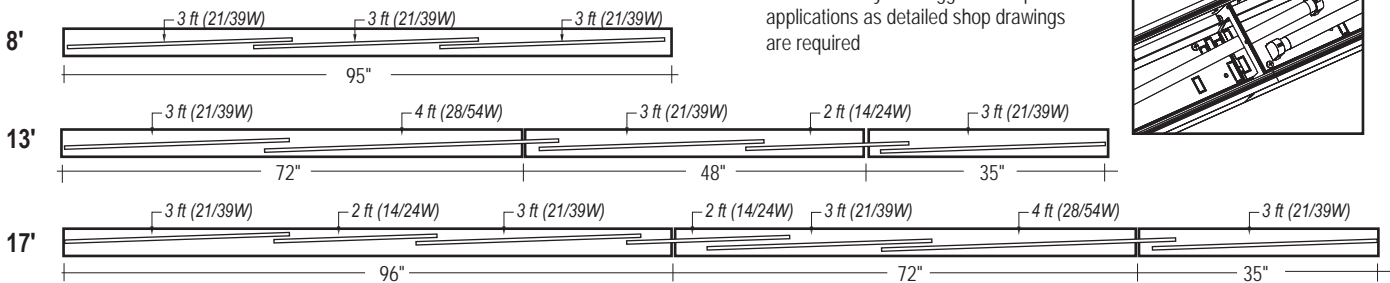

Consult factory for staggered lamp applications as detailed shop drawings are required

