

CONSTRUCTION Extruded aluminum housing with cold rolled steel ends.

REFLECTOR Highly reflective die-formed specular anodized aluminum with asymmetric distribution.

LENS Standard indoor fluorescent luminaires are "open" without lensing unless otherwise specified.

ELECTRICAL Standard T5 and T5HO: Program start 120/277 volt integral electronic ballast with less than 10% THD. Standard T8: Instant start 120/277 volt electronic ballast with less than 10% THD. Through wiring with quick connects standard. Standard single circuit. Each ballast provided with disconnects to meet luminaire disconnect code requirement.

MOUNTING Heavy gauge aluminum brackets mount to structure allowing for easy installation and adjustment of fixture head. Bracket is painted to match fixture housing unless otherwise specified.

FINISH Standard powder-coat textured white painted finish. Consult factory for custom color and finishes.

LABELS UL and cUL Listed and approved for dry/damp location.

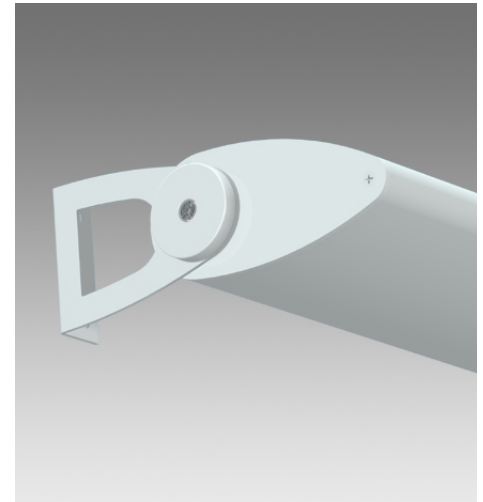
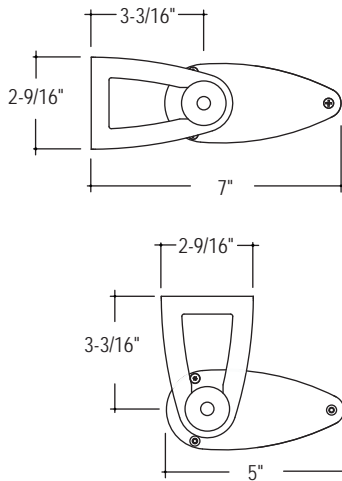

LUMINAIRE SPECIFICATION

Sample Catalog #: V-1T5-24-FL-120-1C-W

V_-	----	----	FL-	----	---	---	---
PRODUCT	LAMPS	LENGTH	MOUNTING	VOLTAGE	CIRCUITING	FINISH	OPTIONS
VU- Vertigo Linear indoor luminaire indirect (UP)	1T5- (1) T5 1T5HO- (1) T5HO 2T5- (2) T5 2T5HO- (2) T5HO 1T8- (1) T8	Individual Units 3- 3' 4- 4' 6- 6' 8- 8' Continuous Runs xx'- Specify nominal overall row length in 1' increments	FL- Flush Mount	120- 120 V 277- 277 V 347- 347 V ¹ UNV- UNV ¹ (120/277)	1C- Single Circuit 2C- Dual Circuit ² 1D- Single Circuit Dimming ² 2D- Dual Circuit Dimming ² 1B- Single Circuit with Battery Pack ² 2B- Dual Circuit with Battery Pack ² 1E- Single Circuit with Emergency Circuit ² 2E- Dual Circuit with Emergency Circuit ²	W- Matte White S- Metallic Silver CC- Custom Color	B- Baffle ³ A- Acrylic Lens ⁴
VD- Vertigo Linear indoor lumi- naire, direct (DOWN)				¹ 347 volt and UNV not available with battery packs.	² Some Vertigo configurations will not accommodate all electrical options. Consult factory.		³ Baffle to match housing finish. ⁴ Baffle and Lens not available together.

ROTATION

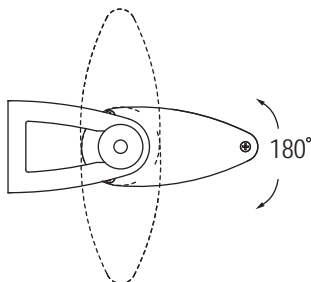
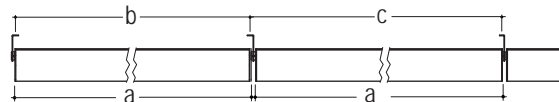
Deco Disc allows for 90 degree rotation of the fixture head in either direction. Move fixture head to desired position and secure deco disc with set screws.

MOUNTING DIMENSION

	Individual Units			
	3'	4'	6'	8'
a. Nominal Length	36-1/4"	48-1/4"	72-1/4"	96-1/4"
b. Mount Spacing	36"	48"	72"	96"
c. Intermediate Mount	37"	49"	73"	97"

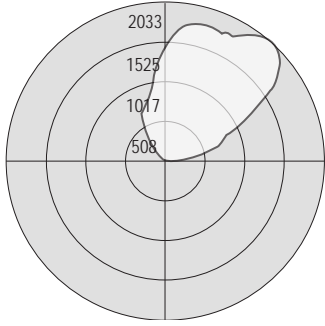

Test # 202270
Lamp: (1) 54 Watt T5HO
Total Luminaire Efficiency: 95.5%

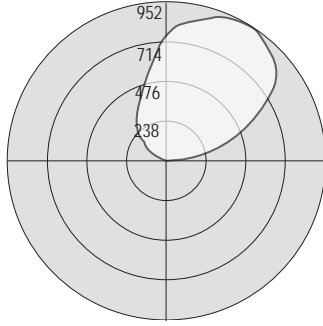

Test # 202271
Lamp: (1) 32 Watt T8
Total Luminaire Efficiency: 77.8%

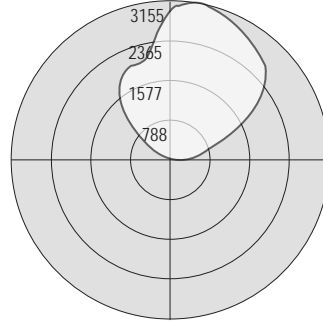

Test # 202272
Lamp: (2) 54 Watt T5HO
Total Luminaire Efficiency: 90.0%

FEATURES AND OPTIONS

• EXTERNAL BAFFLE

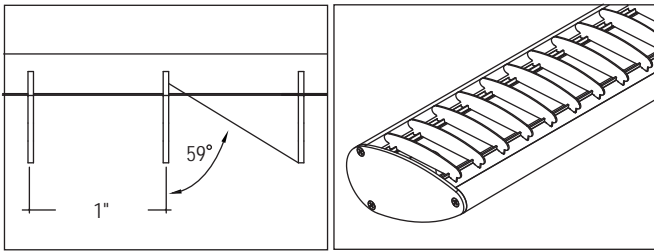

Application: External Baffle controls glare and reduces light output by 15%. Recommended when lengthwise shielding of lamp is required.

Construction: Curved baffles are high reflective white painted aluminum blades. Blade height is 5/8" and spaced 1" on center. Baffles are field installed and feature a snap in attachment allowing for easy lamp replacement.

Ordering Information: Indicate "B" in the Options section of the part number. (Sample Catalog #: V-1T5HO-4-FL-120-W-B).

Restriction: External Baffle is not available in conjunction with Acrylic Lens.

• ACRYLIC LENS

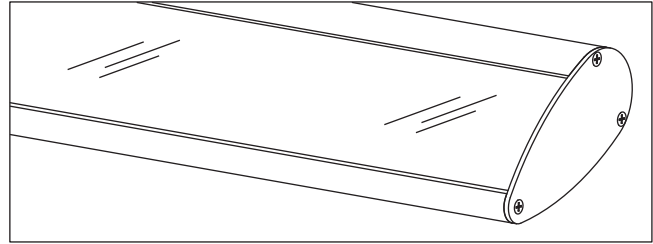

Application: Acrylic lens prevents particle ingress for interior environments.

Construction: One-piece UV stabilized curved linear prismatic acrylic lens. Acrylic lens is removable allowing for easy lamp replacement.

Ordering Information: Indicate "A" in the Options section of the part number. (Sample Catalog #: V-1T5HO-4-FL-120-W-A).

Restriction: Acrylic lens is not available in conjunction with External Baffle.

• MOUNTING DETAIL

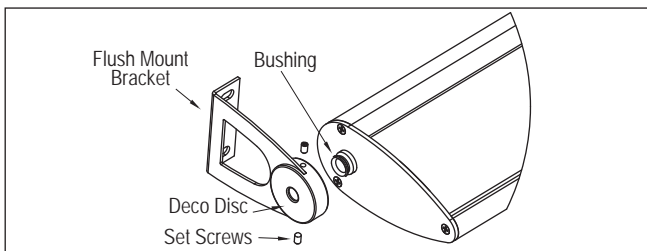

Individual Length	Nominal Row Length																																											
	3	4	6	7	8	9	10	11	12	13	14	15	16	17	18	19	20	21	22	23	24	25	26	27	28	29	30	31	32	33	34	35	36	37	38	39	40	41	42					
3	1			1		3	2	1		1	2	1		1		1		3		1		1		1		1		1		1		1		1		1		1		1		1		
4		1		1			1	2		1		1							2			1		1	1		1			1		1		1	1		1		1		1		1	
6			1							2	1				1	3		2	2	1	2		1	1			1	1			1	1			1	1			1	1			1	1
8					1								1	1	2	1		2	1		2		3	2	2	3	3	2	3	3	4	3	3	4	4	3	4	4	5	4	4			