



**CONSTRUCTION** Extruded aluminum housing in a 5-1/2" by 2-7/8" profile. Standard 4'-0" and 8'-0" fixtures can be joined to create continuous runs.

**REFLECTOR** Standard high reflectance die-formed white painted aluminum. Optional specular reflector available.

**ENDPLATES** Precision fabricated steel endplates are fastened with concealed hardware.

**LENS** Satine Lens is .125" diffuse acrylic lens with matte finish.

**ELECTRICAL** T5, T5HO: Program start 120/277 volt integral electronic ballast with less than 10% THD. T8: Instant start 120/277 volt electronic ballast with less than 10% THD. Through wiring with quick connects standard. Standard single circuit. Each ballast provided with disconnects to meet luminaire disconnect code requirement.

**MOUNTING** Fixture is mounted to structure over a switch box using an adjustable bracket.

**FINISH** Standard powder-coat white painted finish. Consult factory for custom color and finish options.

**LABELS** UL and cUL Listed and approved for dry/damp location.

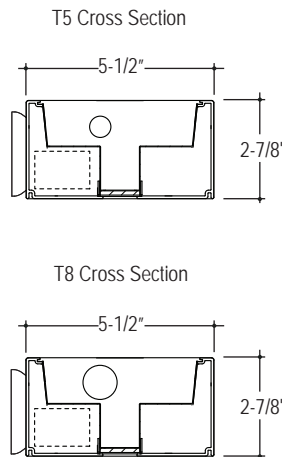

**STANDARD LIGHT DISTRIBUTION**  
Direct: 3%; Indirect: 97%

**LUMINAIRE SPECIFICATION**

Sample Catalog #: RS5A-1T5-32'-WA-120-1C-W

PRODUCT	LAMPS	LENGTH	MOUNTING	VOLTAGE	CIRCUIT/WIRING	FINISH	OPTIONS
RS5A- Ridge <sup>2</sup> 5" Direct/Indirect indoor luminaire with satine lens	1T5- (1) 28W T5 1T5HO- (1) 54W T5HO 1T8- (1) 32W T8	Individual Units 4- 4' 8- 8'  Continuous Runs xx'- Specify nominal overall row length in 4' increments	WA- Wall Mount	120 - 120V 277 - 277V 347 - 347V <sup>1</sup> UNV - UNV <sup>2</sup> (120/277)	1C- Single Circuit 1D- Single Circuit Dimming <sup>3</sup> 1E- Single Circuit with Emergency Circuit <sup>3</sup> 1B- Single Circuit with Battery Pack <sup>3</sup>	W- Matte White CC- Custom Color	DG- Dust Guard <sup>4</sup>

<sup>1</sup>Consult factory for 347 volt ballast.

<sup>2</sup>Not available for use with a battery pack.

<sup>3</sup>Some Ridge configurations are not available for all circuiting options. Consult factory.

<sup>4</sup>Covers top of luminaire

**Individual Luminaires**

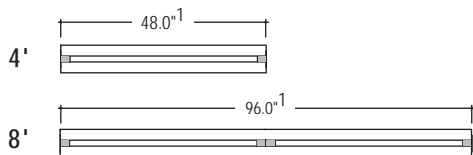

<sup>1</sup>Add 1/8" for each end plate or 1/4" to the overall length of the row.

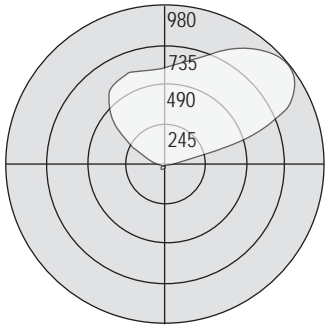

Test #: 203743  
 Part #: RS5A-1T5-4-WA  
 Total Luminaire Efficiency: 91.0%  
 Direct: 3%; Indirect: 97%

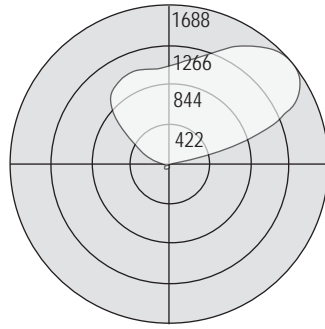

Test #: 203744  
 Part #: RS5A-1T5HO-4-WA  
 Total Luminaire Efficiency: 91.0%  
 Direct: 3%; Indirect: 97%

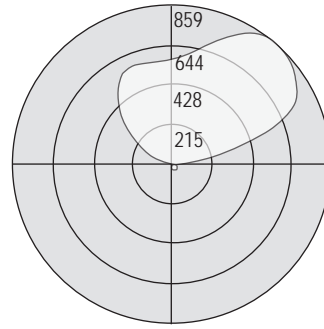

Test #: 203745  
 Part #: RS5A-1T8-4-WA  
 Total Luminaire Efficiency: 85.0%  
 Direct: 3%; Indirect: 97%

FEATURES AND OPTIONS

• MOUNTING DETAIL

Wall Side Mounting

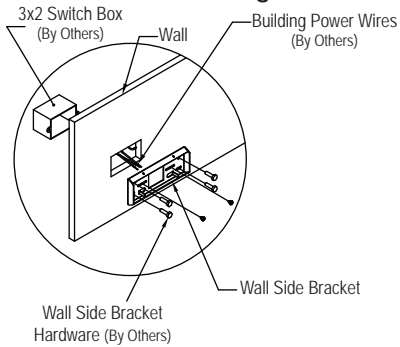

8' Individual Fixture Example

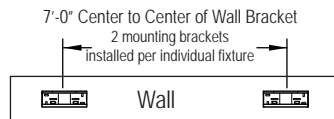

16' Continuous Run Example (2-8' fixture joined)

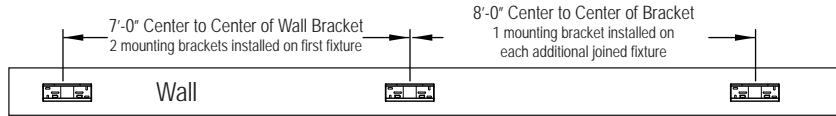

Fixture Side Mounting

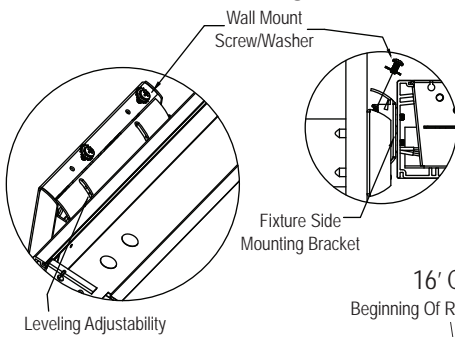

8' Individual Fixture Example

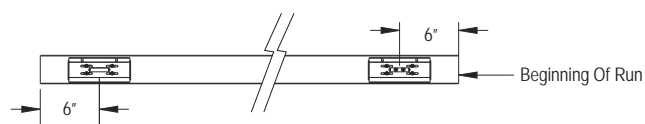

16' Continuous Run Example (2-8' fixture joined)

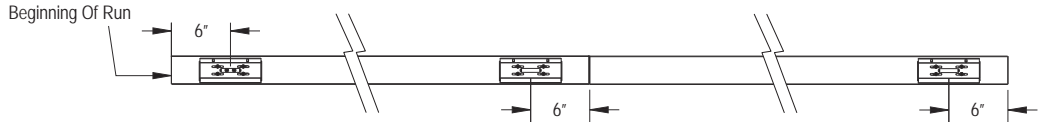

• STANDARD ROW CONFIGURATION

Pinnacle Architectural Lighting utilizes standard row configurations for continuous runs. Please consult factory if a project requires non-standard row configurations.

Individual Length	Nominal Row Length																				
	4	8	12	16	20	24	28	32	36	40	44	48	52	56	60	64	68	72	76	80	
4'	1		1		1		1		1		1		1		1		1		1		
8'		1	1	2	2	3	3	4	4	5	5	6	6	7	7	8	8	9	9	10	