

**CONSTRUCTION** Extruded aluminum housing, die-cast gasketed end caps. Outdoor rated luminaires include mechanically attached and gasketed aluminum door frame.

**REFLECTOR** Highly reflective specular anodized aluminum.

**LENS** Micro-prismatic tempered glass and die-formed aluminum trim (spring secured) for toolless lamp access. For outdoor luminaires, glass is secured to aluminum door frame and mechanically attaches to housing.

**ELECTRICAL** Standard 120/277 volt integral electronic ballast with a power factor greater than 90% and less than 15% THD.

**MOUNTING** Fully rotatable head mounts to structure either at ceiling or wall.

**FINISH** Standard powder-coat white textured painted finish. Consult factory for custom color and finishes.

**LABELS** UL and cUL Listed and approved for dry/damp location or wet location. Specify label required under "Product" section of catalog number.

Deco Extended

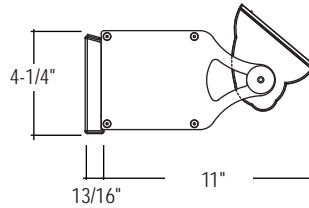

Deco Flush

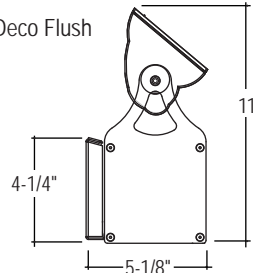

For Indoor and Outdoor Lighting Applications

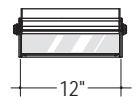
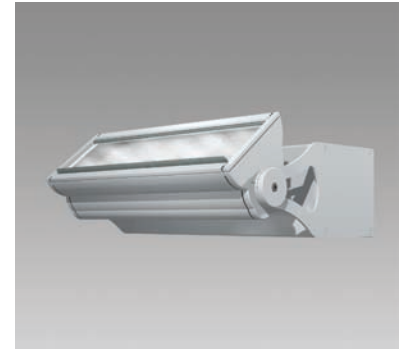

(1) 39W T6, G12 (1) 100W T6, G12  
(1) 70W T6, G12 (1) 150W T6, G12

**LUMINAIRE SPECIFICATION**

Sample Catalog #: PS-M150G-DE-120-1C-W-V

P__-	M____-	__-	____-	1C-	__-	__-	
PRODUCT	LAMPS / LENGTH	MOUNTING	VOLTAGE	CIRCUITING	FINISH	OPTIONS	
PS- Peak indoor luminaire, <b>Smooth</b> Housing, dry/damp label	<b>LAMP</b> M39G- (1) 39W T6, G12 12" M70G- (1) 70W T6, G12 12"	<b>LENGTH</b> 12"	<b>INTEGRAL BALLAST</b> DE- Deco Extended DF- Deco Flush	120- 120 V 277- 277 V 347- 347 V <sup>1</sup> UNV- UNV (120/277)	1C- Single Circuit <sup>2</sup>	W- Matte White S- Metallic Silver BR- Bronze CC- Custom Color	Q- Quartz Restrike <sup>2</sup> B- Baffle <sup>3</sup> V- Visor <sup>3</sup>
PR- Peak indoor luminaire, <b>Ribbed</b> Housing, dry/damp label	M100G- (1) 100W T6, G12 12" M150G- (1) 150W T6, G12 12"	12"					
PSW- Peak outdoor luminaire, <b>Smooth</b> Housing, wet label							
PRW- Peak outdoor luminaire, <b>Ribbed</b> Housing, wet label							
PSN- Peak natatorium luminaire, <b>Smooth</b> Housing, wet label							
PRN- Peak natatorium luminaire, <b>Ribbed</b> Housing, wet label							

<sup>1</sup> Not all lamping and ballast options available. Consult factory.  
<sup>2</sup> Some Peak configurations will not accommodate all electrical options. Consult factory.  
<sup>3</sup> Color will match housing unless otherwise specified.

**AIMING**

Fixture achieves optimal beam angle (a) when "aiming notch" (b) aligns with horizontal or vertical axis. Luminaire head rotates and locks for easy field adjustability.

To light the wall

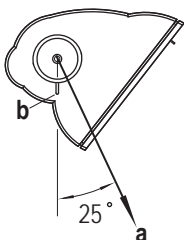

To light the ceiling

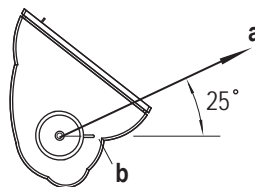

**MOUNTING DIMENSION**

DE - Decorative Extended, Integral Ballast

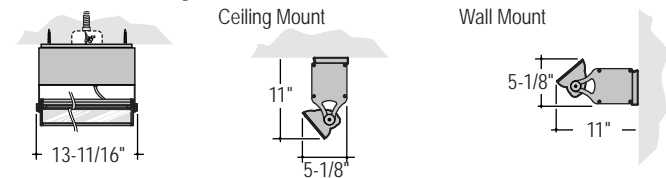

DF - Decorative Flush, Integral Ballast

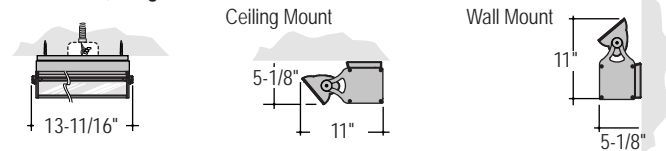

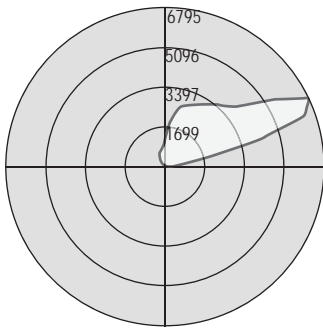

Test # JTL300030  
 Catalog # PS-M150G  
 Total Luminaire Efficiency = 65.00%

Zone	Lumens	%Lamp	%Fixt
0-30	0	0	0
0-40	0	0	0
0-60	.04	0	0
0-90	89.1	.6	1
90-120	3915.9	28	43
90-130	5513.2	39.4	60.6
90-150	7756.6	55.4	85.2
90-180	9015.2	64.4	99
0-180	9104.3	65	100

	0	45	90	135	180
0	0	0	0	0	0
5	0	0	0	0	0
15	0	0	0	0	0
25	0	0	0	0	0
35	0	0	0	0	0
45	0	0	0	0	0
55	0	.21	0	0	0
65	0	.17	0	0	0
75	14	.09	.02	0	0
85	249	151	.87	0	0
90	361	349	15	0	0
95	552	791	91	.03	0
105	3215	3875	338	23	.17
115	6584	4734	624	101	49
125	4746	3305	851	177	129
135	3596	3086	1033	270	192
145	3283	2940	1107	428	278
155	2949	2848	1186	574	498
165	2630	2354	1162	688	623
170	2235	1941	1160	750	675

FEATURES AND OPTIONS

• EXTERNAL BAFFLE

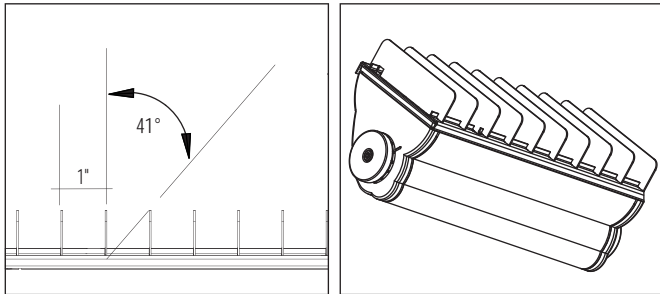

**Application:** External Baffle controls glare and reduces light output by 15%. Recommended when lengthwise shielding of lamp is required.

**Construction:** Straight baffles are high reflective white painted aluminum blades. Blade height is 1-1/8" and spaced 1" on center. Baffles are factory installed and can be easily removed for lamp replacement.

**Ordering Information:** Indicate "B" in the Options section of the part number. (Sample Catalog #: PS-M150G-DE-120-1C-W-B).

• VISOR

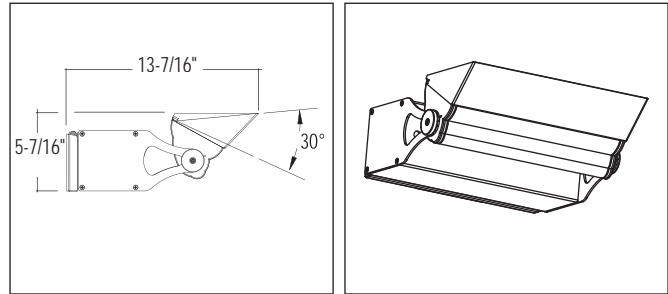

**Application:** Provides 30 degrees of shielding with no interference to peak beam angle. Recommended when glare from the lens or reflector must be shielded.

**Construction:** Solid formed visor mounts to fixture with 2 screws. Visors are field installed. Visors are painted to match fixture housing unless otherwise specified.

**Ordering Information:** Indicate a "V" in the Options section of the part number. (Sample Catalog #: PS-M150G-DE-120-1C-W-V)

• MOUNTING DETAIL

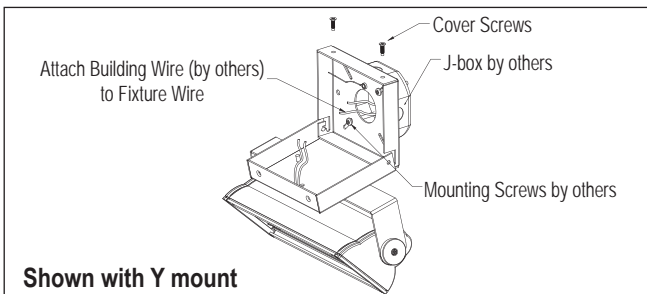

**Assembly:** Fixture remains captive to the mounting plate allowing for hands free wire connection. Once wired, swing fixture back into place and secure with the hardware provided. See installation instructions when installing fixtures. Specification sheets are not to be used as installation instructions.