

CONSTRUCTION One piece die-formed steel housing in a 6-1/4" by 2-1/2" profile. Standard 4'-0" and 8'-0" fixtures can be joined to create continuous runs.

REFLECTOR Standard high reflectance die-formed white painted aluminum.

ENDCAPS Precision die-cast sculpted endcaps are fastened with concealed hardware.

BAFFLE White painted perforated aluminum baffles. 18 - 2" by 2" bottom openings spaced 2-3/8" on center with 1" blade height.

ELECTRICAL T5, T5HO: Program start 120/277 volt integral electronic ballast with less than 10% THD. T8: Instant start 120/277 volt electronic ballast with less than 10% THD. Through wiring with quick connects standard. Standard single circuit. Each ballast provided with disconnects to meet luminaire disconnect code requirement.

MOUNTING Fixture is mounted to structure mounted over a switch box using an adjustable bracket.

FINISH Standard powder-coat white painted finish. Consult factory for custom color and finish options.

LABELS UL and cUL Listed and approved for dry/damp location.

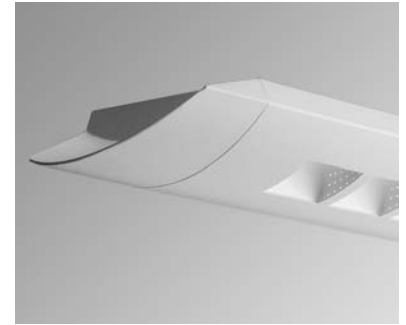
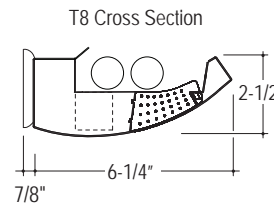
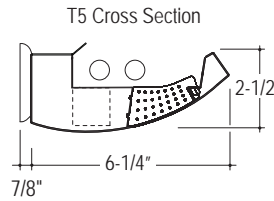

STANDARD LIGHT DISTRIBUTION
Direct 10%; Indirect 90%

Lamp Options

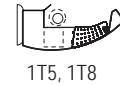

1T5, 1T8



2T5, 2T8

LUMINAIRE SPECIFICATION

Sample Catalog #: G9B-2T5HO-32'-WA-120-1C-W

PRODUCT	LAMPS	LENGTH	MOUNTING	VOLTAGE	CIRCUITING ²	FINISH	OPTIONS
G9B-Glide Direct/Indirect indoor luminaire with side perforated baffle	1T5- (1) 28W T5 2T5- (2) 28W T5 1T5HO- (1) 54W T5HO 2T5HO- (2) 54W T5HO 1T8- (1) 32W T8 2T8- (2) 32W T8	Individual Units 4- 4' 8- 8' Continuous Runs xx'- Specify nominal overall row length in 4' increments	WA- Wall Mount	120- 120 V 277- 277 V 347- 347 V ¹ UNV- UNV ¹ (120/277)	1C- Single Circuit 2C- Dual Circuit ^{2,3} 1D- Single Circuit Dimming ² 2D- Dual Circuit Dimming ^{2,3} 1E- Single Circuit with Emergency Circuit ² 2E- Dual Circuit with Emergency Circuit ^{2,3} 1B- Single Circuit with Battery Pack ²	W- Matte White CC- Custom Color	DG- Dust Guard (Covers top of luminaire)

¹347 volt and UNV not available with battery packs.

²Some Glide configurations will not accommodate all electrical options. Consult factory.

³2 lamps switched side-by-side.

Individual Luminaires

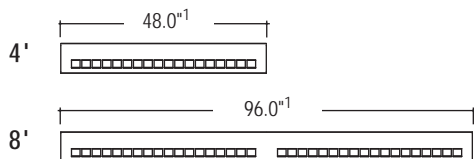

¹Endcaps
Must add 3" for each endcap or 6" to the overall length of the row.



Mounting Detail

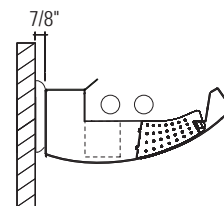

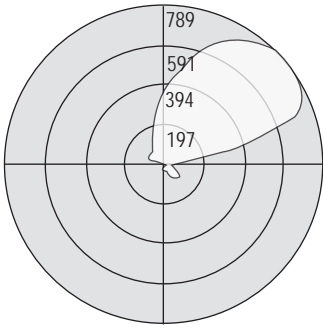

Test #: 203366
 Part #: G9B-1T5-WA
 Total Luminaire Efficiency: 65.5%
 Direct: 10%; Indirect: 90%

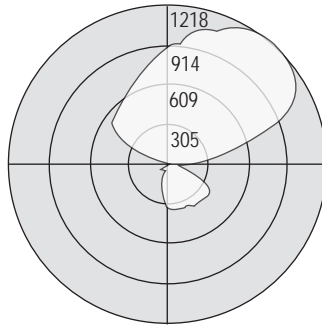

Test #: 203371
 Part #: G9B-2T5-WA
 Total Luminaire Efficiency: 76.6%
 Direct: 20%; Indirect: 80%

• MOUNTING DETAIL

Wall Side Mounting

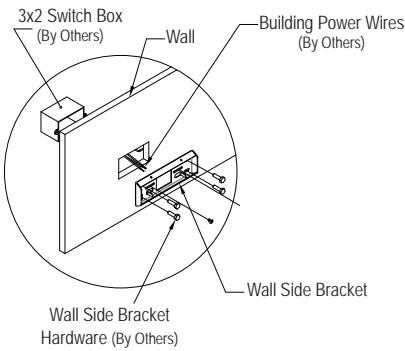

8' Individual Fixture Example

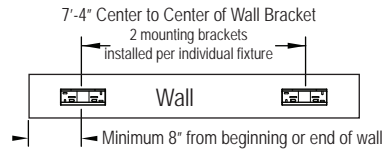

16' Continuous Run Example (2-8' fixture joined)

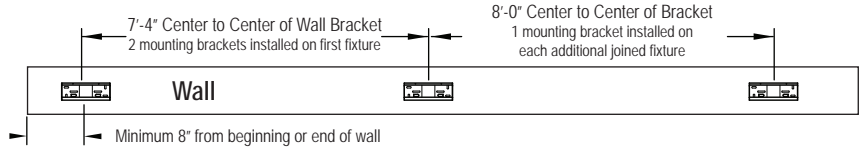

Fixture Side Mounting

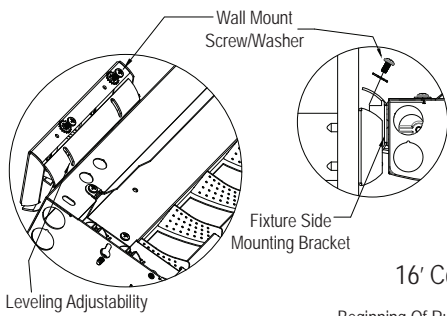

8' Individual Fixture Example

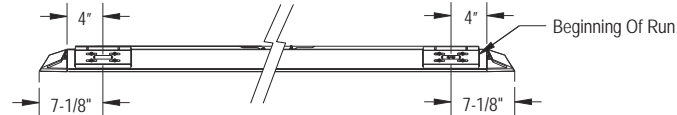

16' Continuous Run Example (2-8' fixture joined)

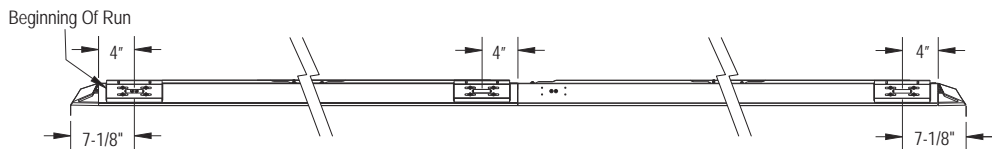

• STANDARD ROW CONFIGURATION

Pinnacle Architectural Lighting utilizes standard row configurations for continuous runs. Please consult factory if a project requires non-standard row configurations.

Individual Length	Nominal Row Length																			
	4	8	12	16	20	24	28	32	36	40	44	48	52	56	60	64	68	72	76	80
4'	1		1		1		1		1		1		1		1		1		1	
8'		1	1	2	2	3	3	4	4	5	5	6	6	7	7	8	8	9	9	10