

Adeo T8 Grid Ceiling Installation

For Lamp/Ballast Maintenance See Separate Maintenance Sheet

Step 1: T-Grid Installation

1. Position fixture up through grid opening.
2. Lower fixture so fixture flanges rest on T-Grid.
3. Tie off fixture to structure with retention wires (by others).

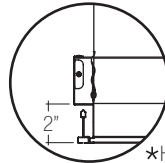
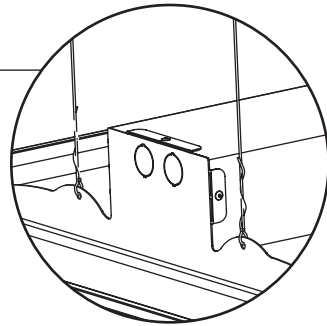
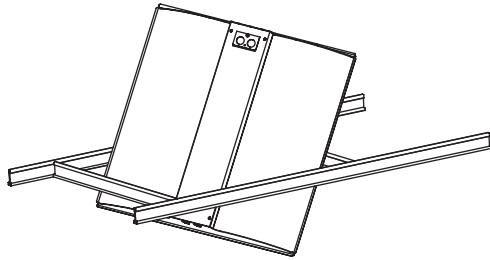

*Housing has fixture extension that goes over T-Grid

Step 2: Making the Connections

1. Remove electrical cover, remove knockout, attach building supplied conduit.
2. Make electrical connections, recess wires into fixture cavity and attach cover.

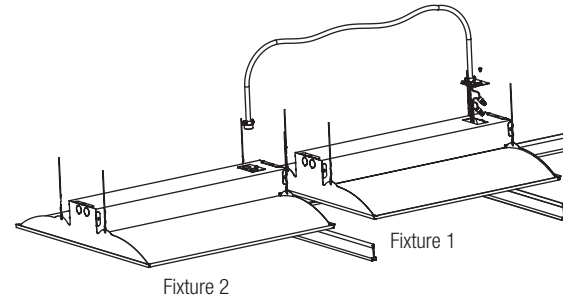
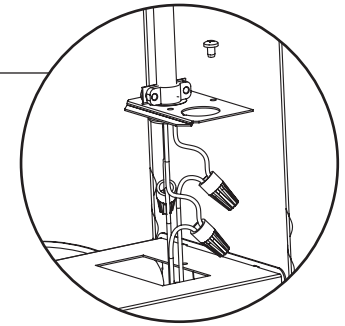

Through-wiring Option *shown with optional flex whip.

1. Pull wiring from fixture 1 into fixture 2 using whip assembly with snap in connectors.
2. Make wiring connections in fixture 2.

Step 3: Installing Lamps

1. Locate notch on lens endcap, pull down from notched side of lens to open.
2. Lens remains captive to fixture for lamp installation and maintenance.

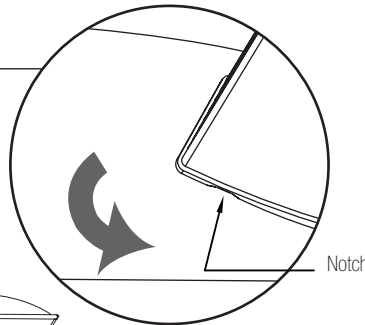
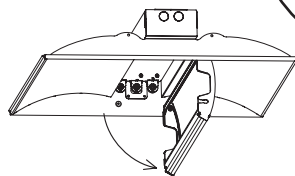
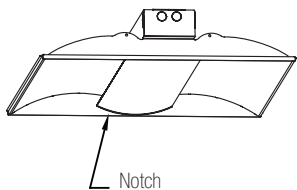

Notch

